

IV1D06020T2 – 650V 20A SiC Schottky Diode

Features

- Max Junction Temperature 175°C
- High Surge Current Capacity
- Extremely Fast Reverse Recovery Time
- Reduced Losses in Associated MOSFET
- High-Frequency Operation
- Temperature Independent Switching Behavior
- Positive Temperature Coefficient on V_F

Outline

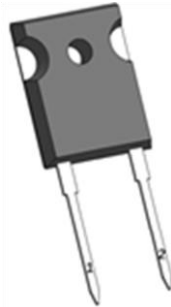

TO247-2

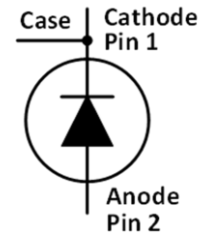

Applications

- PV Micro Inverter
- Adaptor
- TV Power
- Power Factor Correction
- Telecom / Server SMPS

Marking Diagram

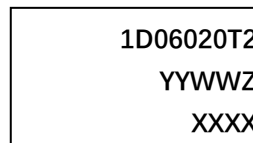

1D06020T2 = Specific Device Code
 YY = Year
 WW = Work Week
 Z = Assembly Location
 XXXX = Lot Traceability

Absolute Maximum Ratings (Tc=25°C unless otherwise specified)

Symbol	Parameter	Value	Unit
V_{RRM}	Reverse voltage (repetitive peak)	650	V
V_{DC}	DC blocking voltage	650	V
I_F	Forward current (continuous) @Tc=25°C	50.1	A
	Forward current (continuous) @Tc=135°C	23.4	A
	Forward current (continuous) @Tc=144°C	20	A
I_{FSM}	Surge non-repetitive forward current sine halfwave @Tc=25°C tp=10ms	120	A
I_{FRM}	Surge repetitive forward current (Freq=0.1Hz, 100cycles) sine halfwave @Tamb=25°C tp=10ms	100	A
P_{tot}	Total power dissipation @ Tc=25°C	176.4	W
	Total power dissipation @ Tc=150°C	29.4	
$\int i^2 dt$	i^2t value @Tc=25°C tp=10ms	72	A ² s
Tstg	Storage temperature range	-55 to 175	°C
Tj	Operating junction temperature range	-55 to 175	°C

Stresses exceeding those listed in the Maximum Ratings table may damage the device. If any of these limits are exceeded, device functionality should not be assumed, damage may occur and reliability may be affected.

Electrical Characteristics

Symbol	Parameter	Typ.	Max.	Unit	Test Conditions	Note
V _F	Forward Voltage	1.45	1.65	V	I _F = 20 A T _J =25°C	Fig. 1
		1.85	2.5		I _F = 20 A T _J =175°C	
I _R	Reverse Current	5	100	μA	V _R = 650 V T _J =25°C	Fig. 2
		30	500		V _R = 650 V T _J =175°C	
C	Total Capacitance	716		pF	V _R = 1 V, T _J = 25°C, f = 1 MHz	Fig. 3
		90.8			V _R = 200 V, T _J = 25°C, f = 1 MHz	
		79.5			V _R = 400 V, T _J = 25°C, f = 1 MHz	
Q _C	Total Capacitive Charge	47.9		nC	V _R = 400 V, T _J = 25°C, $Q_C = \int_0^{V_R} C(V) dV$	Fig. 4
E _C	Capacitance Stored Energy	7.21		μJ	V _R = 400 V, T _J = 25°C, $E_C = \int_0^{V_R} C(V) \cdot V dV$	Fig. 5

Thermal Characteristics

Symbol	Parameter	Typ.	Unit	Note
R _{th(j-c)}	Thermal Resistance from Junction to Case	0.85	°C/W	Fig.7

Typical Performance

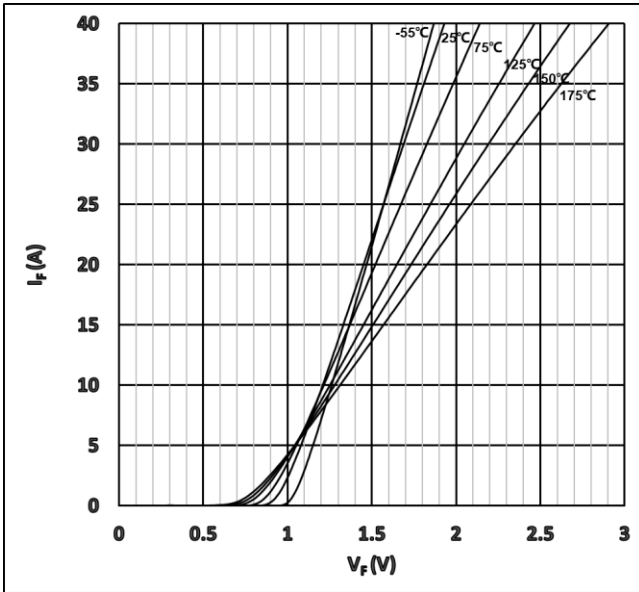

Figure 1. Typical Forward Characteristics

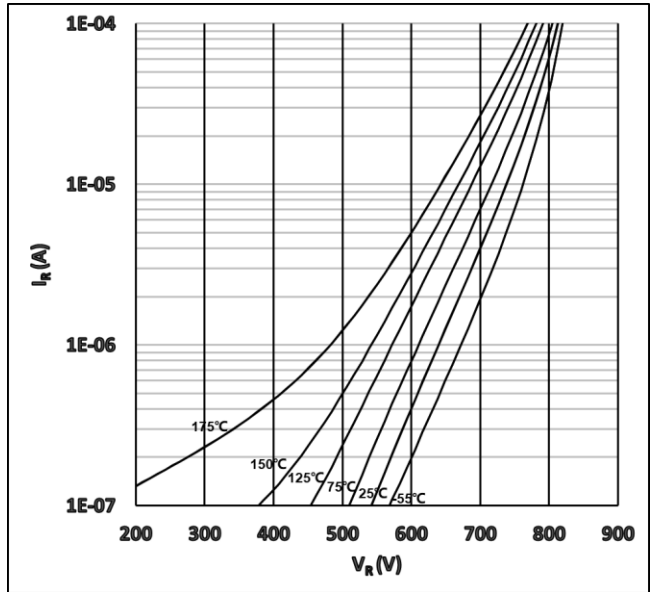

Figure 2. Typical Reverse Characteristics

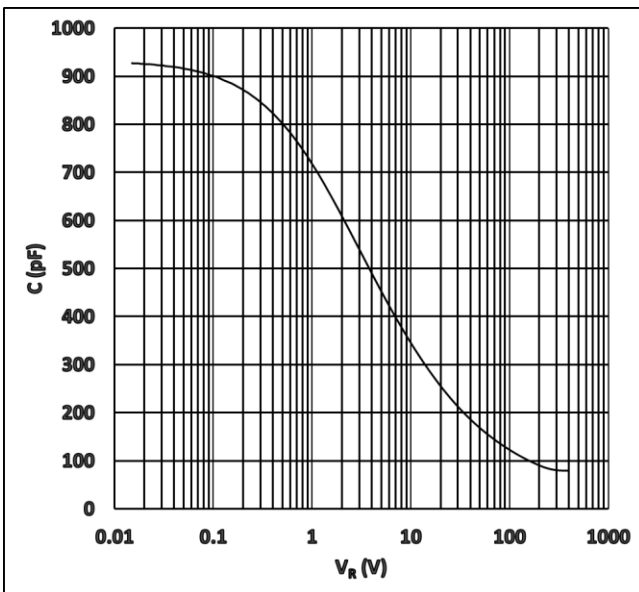

Figure 3. Capacitance vs. Reverse Voltage

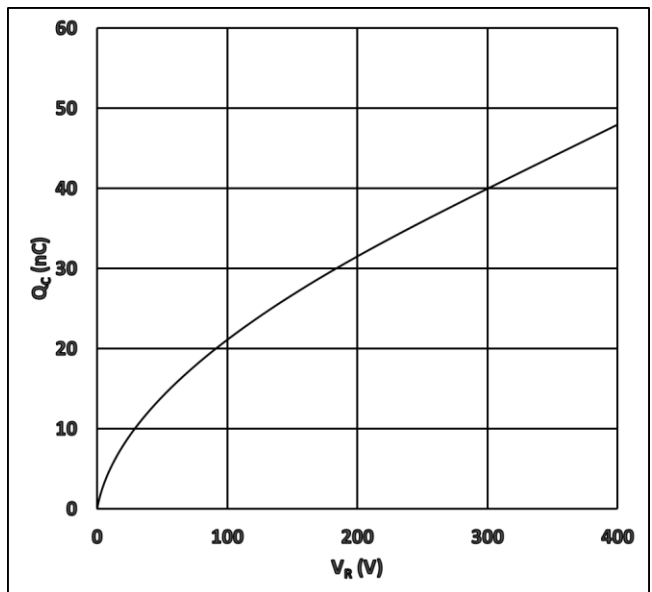

Figure 4. Recovery Charge vs. Reverse Voltage

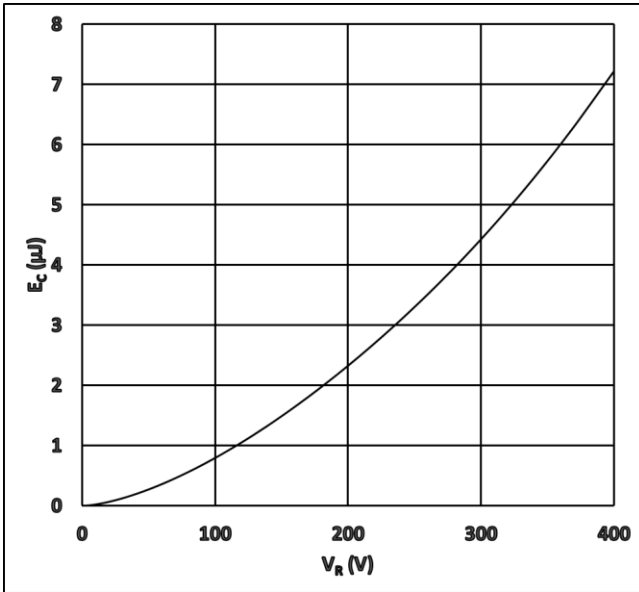

Figure 5. Capacitance Stored Energy

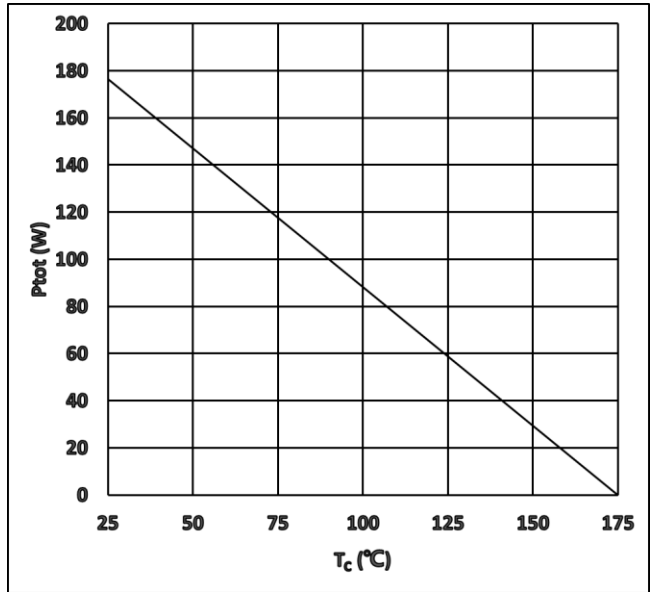

Figure 6. Power Derating

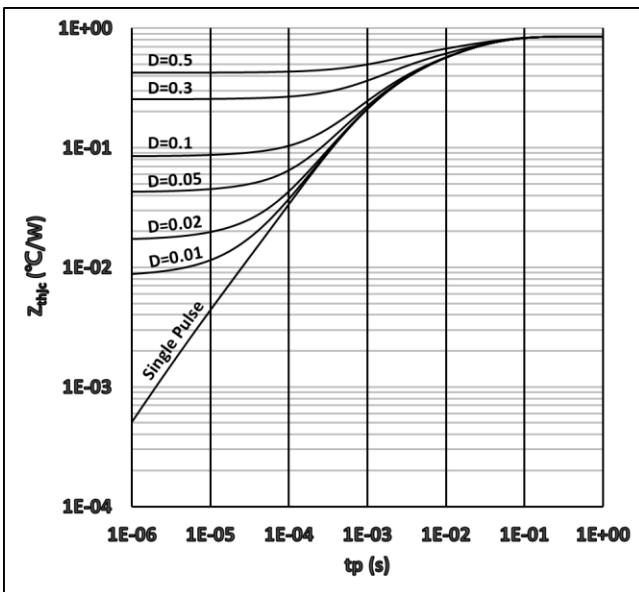

Figure 7. Transient Thermal Impedance

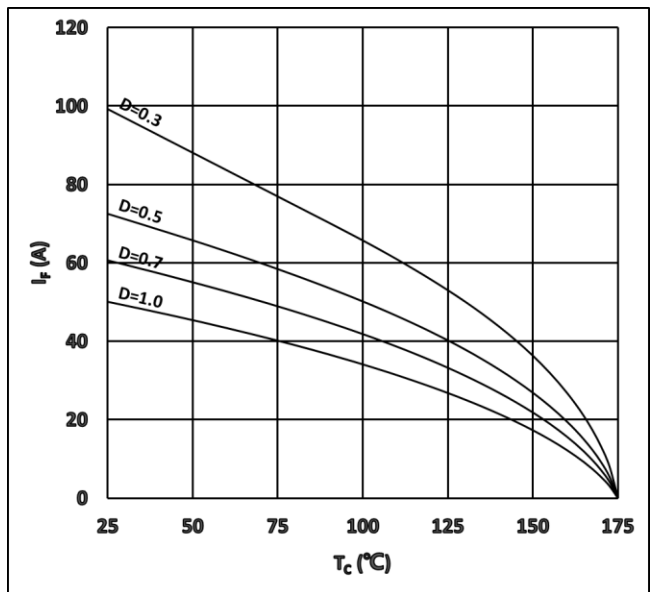
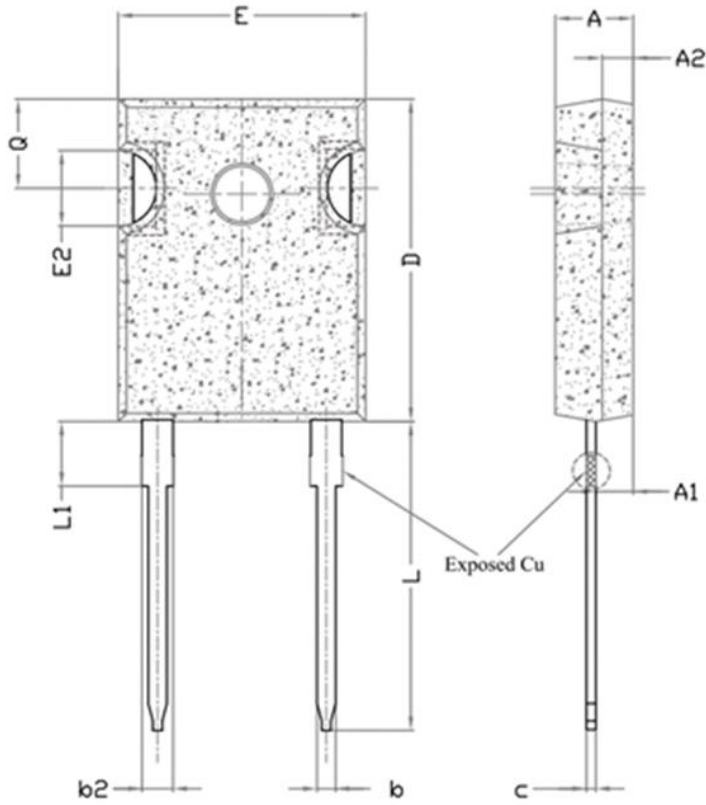
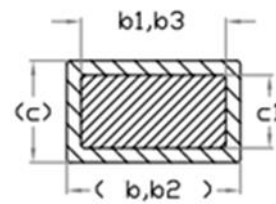
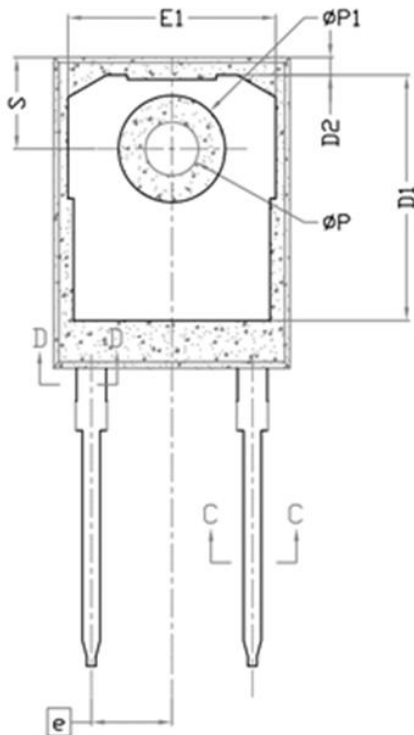

Figure 8. I_f as a Function of Temp.

Package Dimensions



Dimensions In Millimeters		
SYMBOL	MIN.	MAX.
A	4.83	5.21
A1	2.20	2.60
A2	1.50	2.49
b	1.00	1.40
b1	0.99	1.35
b2	1.80	2.41
b3	1.65	2.39
c	0.50	0.70
c1	0.38	0.70
D	20.30	21.10
D1	13.08	-
D2	0.51	1.35
E	15.45	16.13
E1	13.10	-
E2	3.68	5.49
e	5.44 BSC	
L	19.80	21.00
L1	-	4.50
φP	3.50	3.70
φP1	-	7.40
Q	5.39	6.20
S	6.04	6.30



Section C--C,D--D

Note:

1. Package Reference: JEDEC TO247, Variation AD
2. All Dimensions are in mm
3. Slot Required, Notch May Be Rounded or Rectangular
4. Dimension D&E Do Not Include Mold Flash
5. Subject to Change Without Notice

Notes

For further information please contact IVCT's Sales Office.

Copyright©2022 InventChip Technology Co., Ltd. All rights reserved.

The information in this document is subject to change without notice.

Related Links

<http://www.inventchip.com.cn>

