

## Product Summary

$V_R = 650\text{ V}$   
 $I_F = 6\text{ A}$  ( $T_C=150^\circ\text{C}$ )  
 $Q_c = 15\text{ nC}$  ( $V_R=400\text{ V}$ )

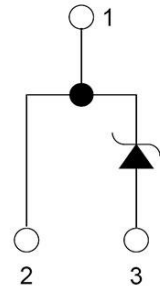
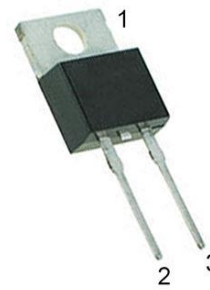

TO-220-2

## Features

- Zero Forward/Reverse Recovery
- High Blocking Voltage
- High Frequency Operation
- Positive Temperature Coefficient on  $V_F$
- Temperature Independent Switching Behavior
- 100% avalanche tested

## Benefits

- High System Efficiency
- Parallel Device Convenience
- High Temperature Application
- High Frequency Operation
- Hard Switching & High Reliability
- Environmental Protection

## Applications

- Switch Mode Power Supplies
- Solar Inverters
- AC/DC converters
- DC/DC converters
- Uninterruptable power supplies

## Maximum Ratings ( $T_C=25^\circ\text{C}$ unless otherwise specified)

Parameter	Symbol	Test conditions	Value	Unit
Peak Repetitive Reverse Voltage	$V_{RRM}$		650	V
Peak Reverse Surge Voltage	$V_{RSM}$		650	V
DC Blocking Voltage	$V_R$		650	V
Continuous Forward Current	$I_F$	$T_C=25^\circ\text{C}$ $T_C=135^\circ\text{C}$ $T_C=150^\circ\text{C}$	19 8 6	A
Non repetitive Forward Surge Current	$I_{FSM}$	$T_C = 25^\circ\text{C}$ , $t_p=10\text{ ms}$ , Half Sine Pulse $T_C = 110^\circ\text{C}$ , $t_p=10\text{ ms}$ , Half Sine Pulse $T_C = 25^\circ\text{C}$ , $t_p=10\text{ }\mu\text{s}$ , Square	40 35 300	A
Repetitive peak Forward Surge Current	$I_{FRM}$	$T_C = 25^\circ\text{C}$ , $t_p=10\text{ ms}$ , Freq = 0.1Hz, 100 cycles, Half Sine Pulse $T_C = 110^\circ\text{C}$ , $t_p=10\text{ ms}$ , Freq = 0.1Hz, 100 cycles, Half Sine Pulse	35 30	A
Total power dissipation	$P_D$	$T_C=25^\circ\text{C}$	68	W
Operating Junction Temperature	$T_J$		-55 to 175	$^\circ\text{C}$
Storage Temperature	$T_{STG}$		-55 to 175	$^\circ\text{C}$

Stresses exceeding those listed in the Maximum Ratings table may damage the device. If any of these limits are exceeded, device functionality should not be assumed, damage may occur and reliability may be affected.

### Electrical Characteristics

Parameter	Symbol	Test conditions	Min	Typ	Max	Unit
DC Blocking Voltage	$V_{DC}$	$I_R = 250\mu A, T_J = 25^\circ C$	650			V
Forward Voltage	$V_F$	$I_F = 6A, T_J = 25^\circ C$		1.45	1.8	V
		$I_F = 6A, T_J = 125^\circ C$		1.6		
		$I_F = 6A, T_J = 175^\circ C$		1.75		
Reverse Current	$I_R$	$V_R = 650V, T_J = 25^\circ C$		7	80	$\mu A$
		$V_R = 650V, T_J = 125^\circ C$		38		
		$V_R = 650V, T_J = 175^\circ C$		108		
Total Capacitive Charge	$Q_C$	$V_R = 400V$		15		nC
Total Capacitance	C	$V_R = 1V, T_J = 25^\circ C,$ Freq = 1MHz		230		pF
		$V_R = 200V, T_J = 25^\circ C,$ Freq = 1MHz		33		
		$V_R = 400V, T_J = 25^\circ C,$ Freq = 1MHz		24		

### Thermal Characteristics

Parameter	Symbol	Condition	Min	Typ	Max	Unit
Thermal Resistance	$R_{th(j-c)}$	junction-case		1.8		$^\circ C/W$

Typical Electrical Curves

Figure 1. Forward Characteristics

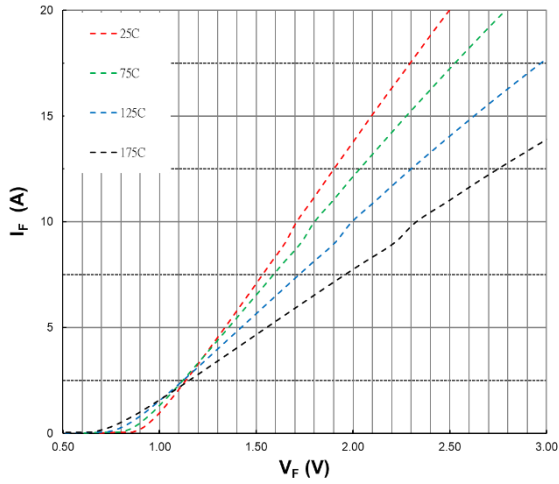

Figure 2. Forward Characteristics

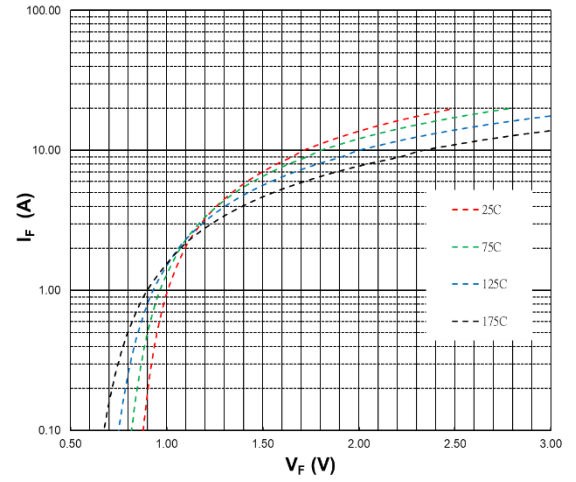

Figure 3. Reverse Characteristics

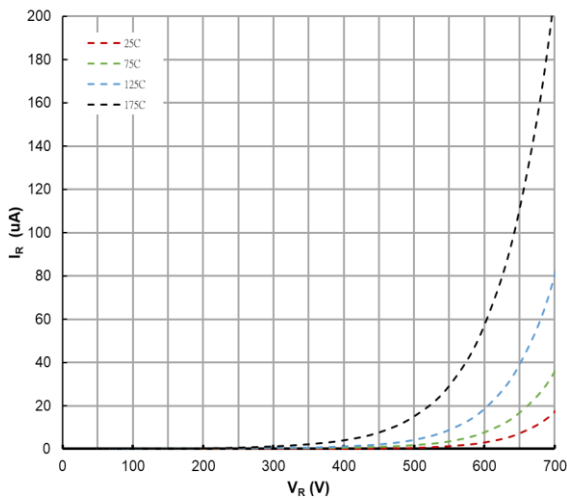

Figure 4. Power Derating

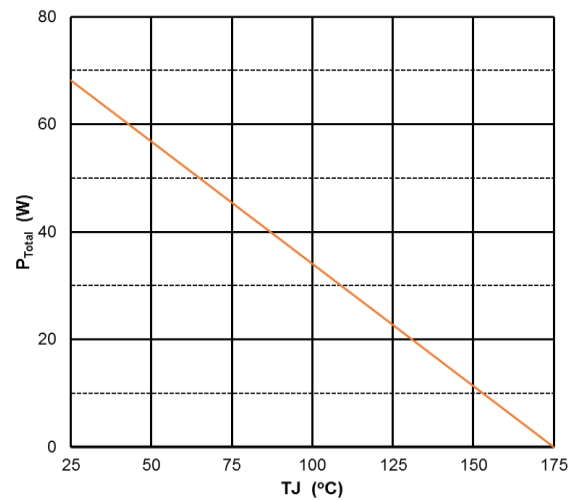

Figure 5. Capacitance vs Reverse Voltage

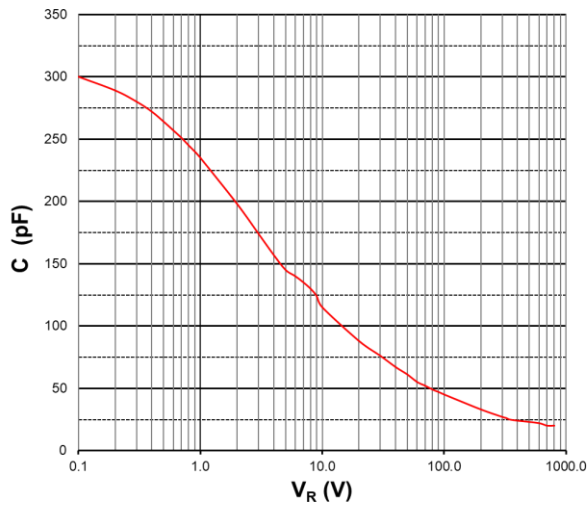
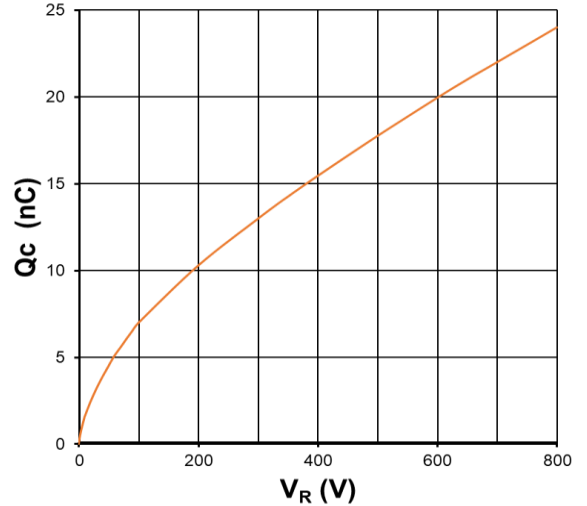

Figure 6. Recovery Charge vs Reverse Voltage



# KN3D06065A

## Silicon Carbide Schottky Diode

### Package Dimensions

(TO-220-2 Package)

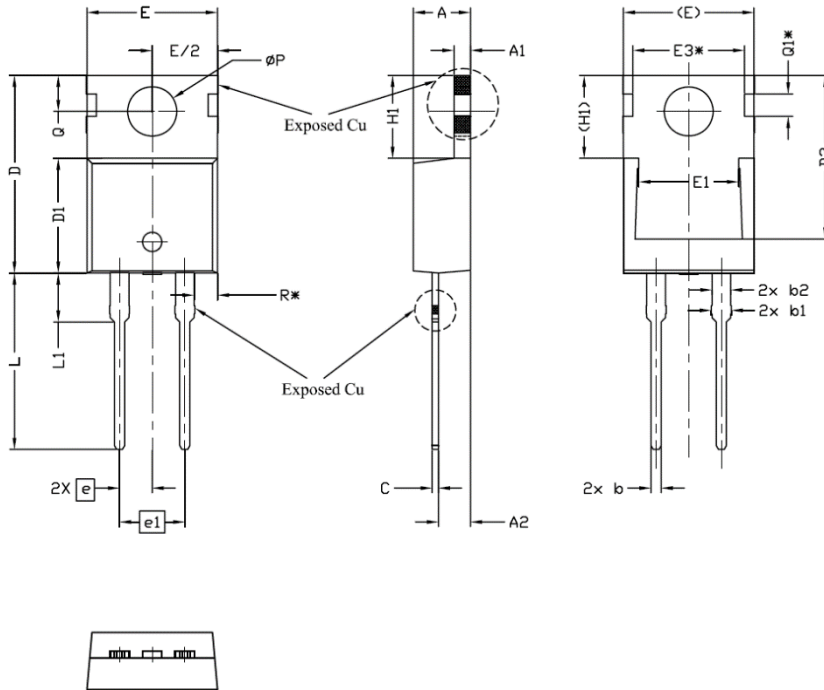

SYMBOL	DIMENSIONS			NOTES
	MIN.	NOM.	MAX.	
A	4.24	4.44	4.64	
A1	1.15	1.27	1.40	
A2	2.30	2.48	2.70	
b	0.70	0.80	0.90	
b1	1.20	1.55	1.75	
b2	1.20	1.45	1.70	
c	0.40	0.50	0.60	
D	14.70	15.37	16.00	4
D1	8.82	8.92	9.02	
D2	12.43	12.73	12.83	5
E	9.96	10.16	10.36	4,5
E1	6.86	7.77	8.89	5
E3*	8.70REF.			
e	2.54BSC			
e1	5.08BSC			
H1	6.30	6.45	6.60	5,6
L	13.47	13.72	13.97	
L1	3.60	3.80	4.00	
ØP	3.75	3.84	3.93	
Q	2.60	2.80	3.00	
Q1*	1.73REF.			
R*	1.82REF.			

Note:

1. Package Reference: JEDEC TO220, Variation AB.
2. All Dimensions Are In mm.
3. Slot Required, Notch May Be Rounded
4. Dimension D & E Do Not Include Mold Flash. Mold Flash Shall Not Exceed 0.127mm Pre Side. These Dimensions Are Measured At The Outermost Extreme Of The Plastic Body.
5. Thermal Pad Contour Optional Within Dimensions E, H1, D2 & E1.
6. Dimension E2 & H1 Define A Zone Where Stamping And Singulation Irregularities Are Allowed.
7. "\*" is reference .

Part Number	Package	Packing	Marking	M.O.Q
KN3D06065A	TO-220-2	50pcs / Tube	KN3D06065A	500