

Features

- High Efficiency (Up to 90%)
- Second Generation with Improved Performance
- Active Power Factor Correction (Typical 0.95)
- Constant Current Output
- Waterproof (IP66) and Damp Location
- Dimming Control
- All-Around Protection: OVP, SCP, OLP, OTP
- SELV and Class 2
- UL Type TL (Temperature Limited)



Description

The EUC-042SxxxDS(PS) series operates from a 90 ~ 305 Vac input range. They are designed to be highly efficient and highly reliable. Features include dimming control, over voltage protection, short circuit protection, over load protection, and over temperature protection.

Models

Output Current	Input Voltage Range(1)	Output Voltage Range	Max. Output Power	Typical Efficiency (2)	Power Factor		Model Number
					120Vac	220Vac	
350 mA	90 ~ 305 Vac	60~120Vdc	42 W	90.0%	0.96	0.95	EUC-042S035DS(PS)(3)
450 mA	90 ~ 305 Vac	47~94 Vdc	42 W	89.0%	0.96	0.95	EUC-042S045DS(PS)(3)
530 mA	90 ~ 305 Vac	40~79 Vdc	42 W	89.0%	0.96	0.95	EUC-042S053DS(PS)(3)
700 mA	90 ~ 305 Vac	28~56 Vdc	39 W	89.0%	0.96	0.95	EUC-042S070DS(PS)(4)(6)
1050 mA	90 ~ 305 Vac	20~38 Vdc	40 W	88.0%	0.96	0.95	EUC-042S105DS(PS)(5)(6)
1280 mA	90 ~ 305 Vac	17~32 Vdc	42 W	87.0%	0.96	0.95	EUC-042S128DS(PS)(5)(6)
1400 mA	90 ~ 305 Vac	15~30 Vdc	42 W	87.0%	0.96	0.95	EUC-042S140DS(PS)(5)(6)
1750 mA	90 ~ 305 Vac	12~24 Vdc	42 W	87.0%	0.96	0.95	EUC-042S175DS(PS)(5)

Notes: (1) UL, FCC certified input voltage range: 100-277Vac; other certified input voltage range except UL, FCC: 100-240Vac.

(2) Measured at full load and 220 Vac input.

(3) Non-Class 2 output (USR & CNR).

(4) Class 2 output (USR), Non-Class 2 output (CNR).

(5) Class 2 output (USR & CNR).

(6) Meet with KC Certification.

Input Specifications

Parameter	Min.	Typ.	Max.	Notes
Input Voltage	90 V	-	305 V	
Input Frequency	47 Hz	-	63 Hz	

Input Specifications (Continued)

Parameter	Min.	Typ.	Max.	Notes
Leakage Current	-	-	0.75 MIU	UL8750; 277Vac/ 60Hz
	-	-	0.70 mA	IEC60598-1; 240Vac/ 60Hz
Input AC Current	-	-	0.7 A	Measured at full load and 100 Vac input.
	-	-	0.3 A	Measured at full load and 220 Vac input.
Inrush Current(I^2t)	-	-	0.32 A ² s	At 220Vac input 25°C Cold Start. Duration=200 μ s, 10%lpk-10%lpk. See Inrush Current Waveform for the details.
Power Factor	0.90	-	-	At 100-277Vac, 75%-100%load(31.5~42W)
THD	-	-	20%	

Output Specifications

Parameter	Min.	Typ.	Max.	Notes
Output Current Tolerance	-5% I_o	-	5% I_o	
No Load Output Voltage				
$I_o = 350$ mA	-	-	132 V	
$I_o = 450$ mA	-	-	104 V	
$I_o = 530$ mA	-	-	87 V	
$I_o = 700$ mA	-	-	59 V	
$I_o = 1050$ mA	-	-	42 V	
$I_o = 1280$ mA	-	-	37 V	
$I_o = 1400$ mA	-	-	34 V	
$I_o = 1750$ mA	-	-	27 V	
Total Output Current Ripple (pk-pk)	-	-	50% I_o	Related to V-I Curve of the LED
Output Current Overshoot / Undershoot	-	-	10% I_o	At full load condition
Line Regulation	-	-	$\pm 1\%$	Measured at full load condition
Load Regulation	-	-	$\pm 3\%$	Measured at full load condition
Turn-on Delay Time	-	0.40 s	0.75 s	Measured at 120Vac input, 75%load-100%load
	-	0.30 s	0.50 s	Measured at 220Vac input, 75%load-100%load
Temperature Coefficient of I_{omax}	-	-	0.2%/°C	Case temperature = 0°C ~Tc max
12V Auxiliary Output Voltage	10.8 V	12 V	13.2 V	
12V Auxiliary Output Source Current	0 mA	-	20 mA	Return terminal is "Dim-".

Note: All specifications are typical at 25°C unless otherwise stated.

General Specifications

Parameter	Min.	Typ.	Max.	Notes
Efficiency at 120 Vac input: $I_o = 350 \text{ mA}$ $I_o = 450 \text{ mA}$ $I_o = 530 \text{ mA}$ $I_o = 700 \text{ mA}$ $I_o = 1050 \text{ mA}$ $I_o = 1280 \text{ mA}$ $I_o = 1400 \text{ mA}$ $I_o = 1750 \text{ mA}$	87% 86% 86% 86% 85% 84% 84% 84%	89% 88% 88% 88% 86% 86% 85% 85%	- - - - - - - -	Measured at full load and steady-state temperature in 25°C ambient.
Efficiency at 220 Vac input: $I_o = 350 \text{ mA}$ $I_o = 450 \text{ mA}$ $I_o = 530 \text{ mA}$ $I_o = 700 \text{ mA}$ $I_o = 1050 \text{ mA}$ $I_o = 1280 \text{ mA}$ $I_o = 1400 \text{ mA}$ $I_o = 1750 \text{ mA}$	88% 87% 87% 87% 86% 85% 85% 85%	90% 89% 89% 89% 88% 87% 87% 87%	- - - - - - - -	Measured at full load and steady-state temperature in 25°C ambient.
Efficiency at 277 Vac input: $I_o = 350 \text{ mA}$ $I_o = 450 \text{ mA}$ $I_o = 530 \text{ mA}$ $I_o = 700 \text{ mA}$ $I_o = 1050 \text{ mA}$ $I_o = 1280 \text{ mA}$ $I_o = 1400 \text{ mA}$ $I_o = 1750 \text{ mA}$	88% 87% 87% 87% 86% 85% 85% 85%	90% 89% 89% 89% 88% 87% 87% 87%	- - - - - - - -	Measured at full load and steady-state temperature in 25°C ambient.
No Load Power Dissipation	-	-	6 W	
MTBF	327,000 Hours	-	-	Measured at 120Vac input, 80%Load and 25°C ambient temperature (MIL-HDBK-217F)
Life Time	-	116,000 Hours	-	Measured at 120Vac input, 80%Load and 60°C Case temperature. See life time vs. Tc curve for the details
Operating Case Temperature for Safety Tc_s	-40 °C	-	+90 °C	
Operating Case Temperature for Warranty Tc_w	-40 °C	-	+70 °C	Humidity: 10% RH to 100% RH.
Operating Case Temperature for Type TL Tc_TL	-40 °C	-	+72 °C	
Storage Temperature	-40 °C	-	+85 °C	Humidity: 5% RH to 100% RH
Dimensions Inches (L × W × H) Millimeters (L × W × H)	3.74 × 2.76 × 1.26 95 × 70 × 32			
Net Weight	-	390 g	-	

Note: All specifications are typical at 25°C unless otherwise stated.

Dimming Specifications

Parameter	Min.	Typ.	Max.	Notes
Absolute Maximum Voltage on the 0~10V Input Pin	0 V	-	15 V	
Source Current on 0~10V Input Pin	0 uA	200 uA	250 uA	
Dimming Output Range	10%Iomax		100%Iomax	
Recommended Dimming Input Range	0 V	-	10 V	

Safety & EMC Compliance

Safety Category	Standard
UL/CUL	UL 8750,UL 1310,CAN/CSA-C22.2 No. 250.13-12,CAN/CSA-C22.2 No. 223-M91
CE	EN 61347-1, EN61347-2-13
CCC	GB 19510.1, GB 19510.14
KS	KS C 7655: 2011
EMI Standards	Notes
EN 55015 ⁽¹⁾	Conducted emission Test & Radiated emission Test
EN 61000-3-2	Harmonic Current Emissions
EN 61000-3-3	Voltage Fluctuations & Flicker
FCC Part 15 ⁽¹⁾	ANSI C63.4:2009 Class B This device complies with Part 15 of the FCC Rules. Operation is subject to the following two conditions: [1] this device may not cause harmful interference, and [2] this device must accept any interference received, including interference that may cause undesired operation.
EMS Standards	Notes
EN 61000-4-2	Electrostatic Discharge (ESD): 8 kV air discharge, 4 kV contact discharge
EN 61000-4-3	Radio-Frequency Electromagnetic Field Susceptibility Test-RS
EN 61000-4-4	Electrical Fast Transient / Burst-EFT
EN 61000-4-5	Surge Immunity Test: AC Power Line: line to line 2 kV
EN 61000-4-6	Conducted Radio Frequency Disturbances Test-CS
EN 61000-4-8	Power Frequency Magnetic Field Test
EN 61000-4-11	Voltage Dips
EN 61547	Electromagnetic Immunity Requirements Applies To Lighting Equipment

Note: (1) This LED driver meets the EMI specifications above, but EMI performance of a luminaire that contains it depends also on the other devices connected to the driver and on the fixture itself.

Lifetime vs. Case Temperature Curve

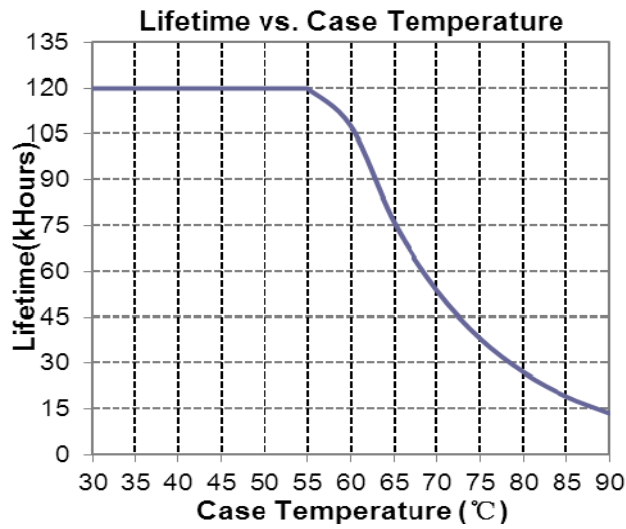

Inrush Current Waveform

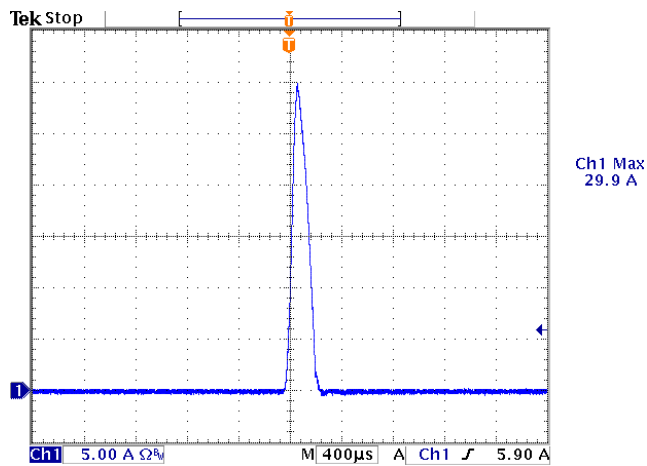

Efficiency vs. Load

EUC-042S035DS(PS)

Efficiency vs. Output Voltage

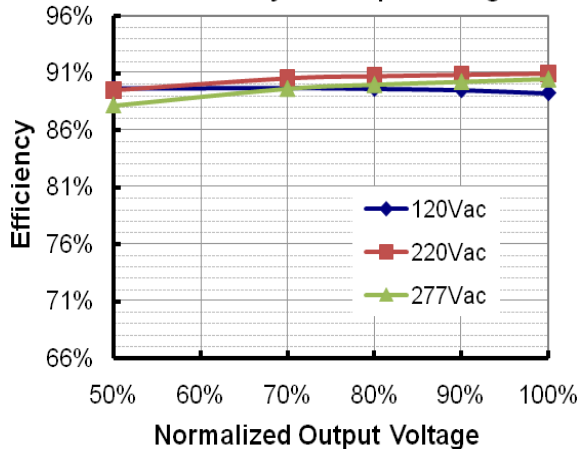

EUC-042S045DS(PS)

Efficiency vs. Output Voltage

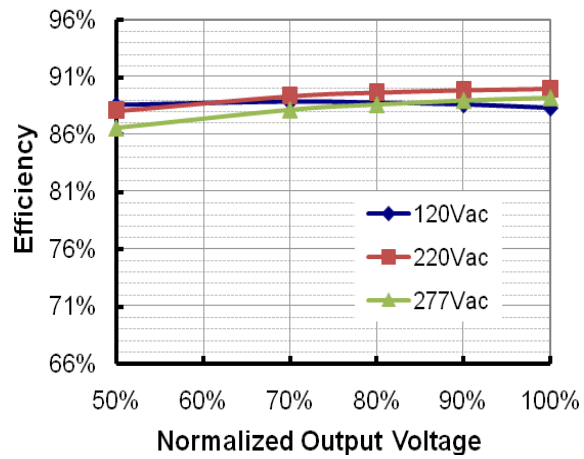

EUC-042S053DS(PS)

Efficiency vs. Output Voltage

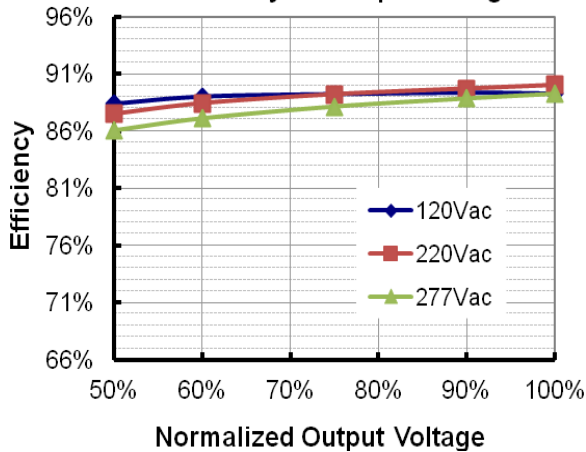

EUC-042S070DS(PS)

Efficiency vs. Output Voltage

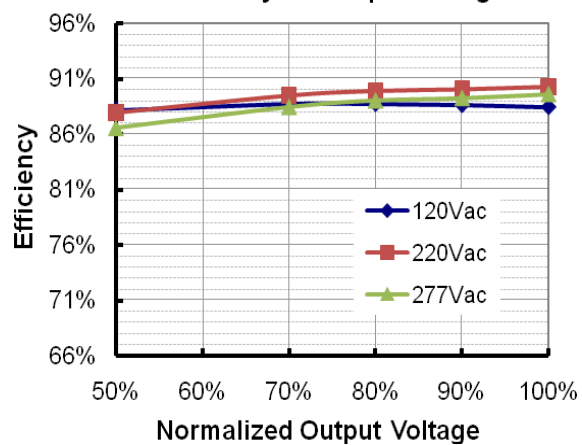

EUC-042S105DS(PS)

Efficiency vs. Output Voltage

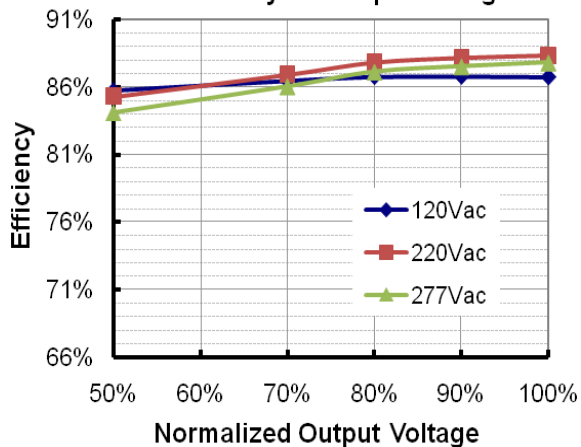

EUC-042S128DS(PS)

Efficiency vs. Output Voltage

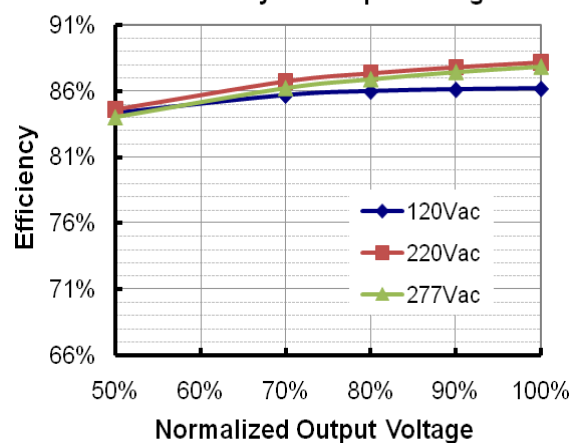

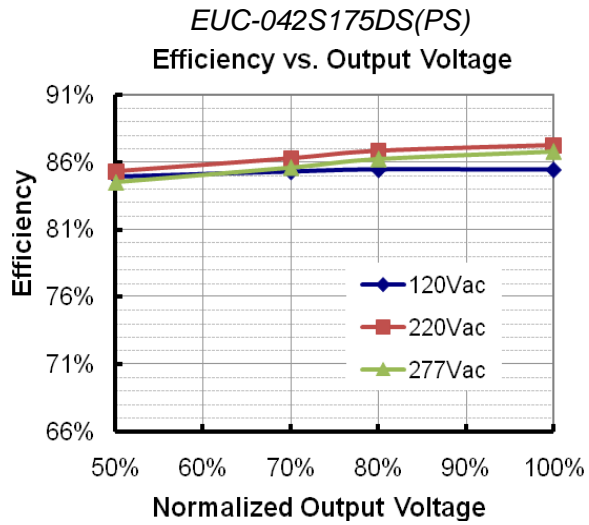
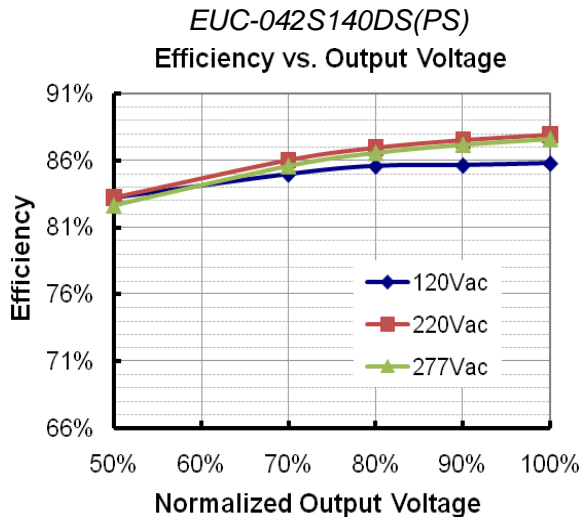

Power Factor Characteristics

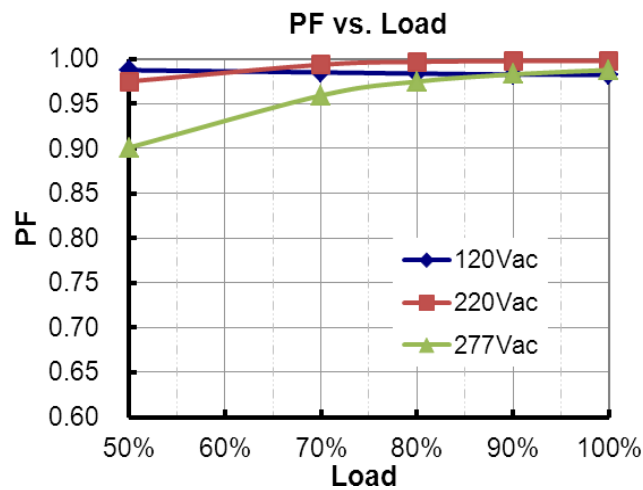

Total Harmonic Distortion

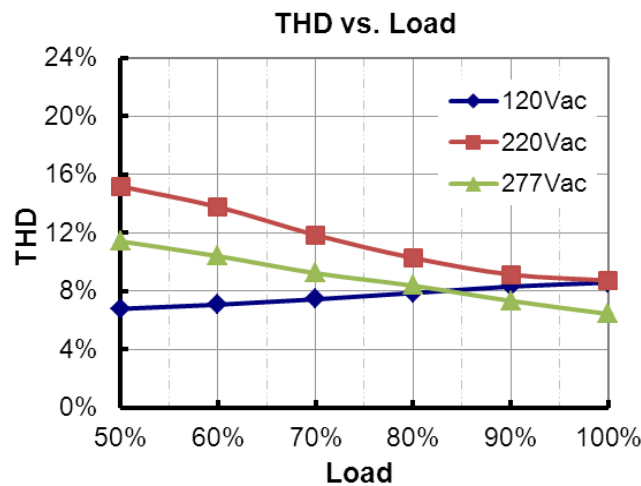

Protection Functions

Parameter	Notes
Over Voltage Protection	Limits output voltage at no load and in case the normal voltage limit fails.
Short Circuit Protection	Auto Recovery. No damage shall occur when any output operating in a short circuit condition. The power supply shall be self-recovery when the fault condition is removed.
Over Temperature Protection	Auto Recovery. Returning to normal after over temperature is removed.

Dimming Control

● 0-10V Dimming

The dimmer control may be operated from either a dimmer or from an input signal of 0 - 10 Vdc. The recommended implementation is provided below.

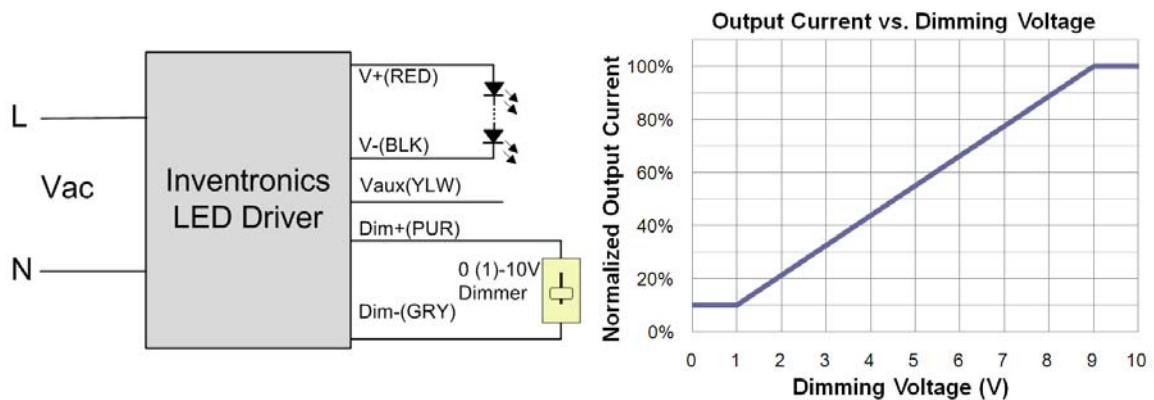

Implementation 1: DC Input

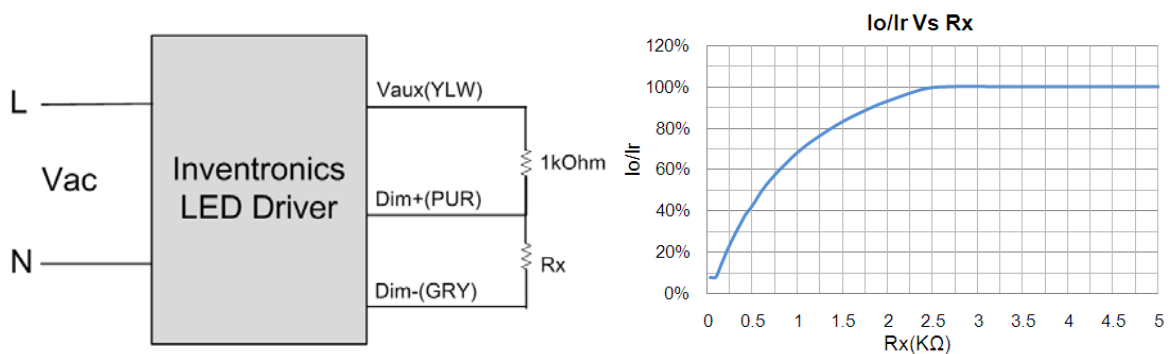

Implementation 2: External Resistor

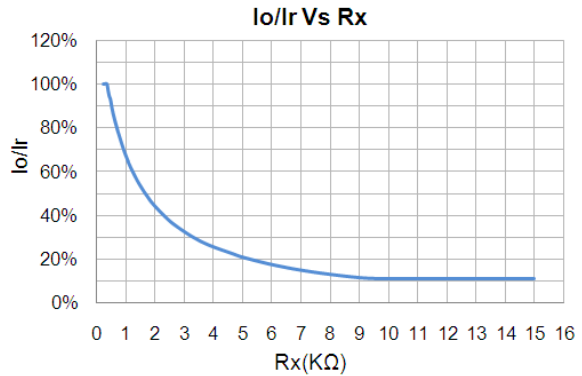
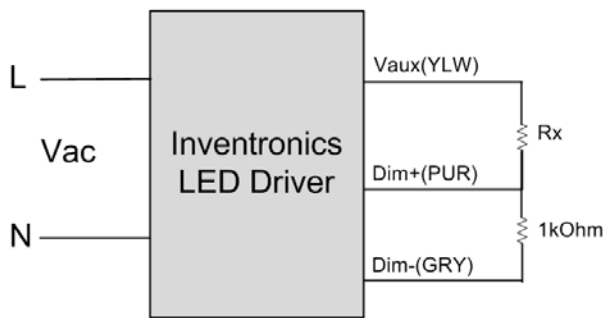

Implementation 3: External Resistor

Notes:

1. Do not connect the Dim- to the V-, otherwise, the LED driver cannot work normally.
2. If 0-10V dimming is not used, Dim + can be either open or connected to Vaux.

Mechanical Outline

EUC-042SxxxDS

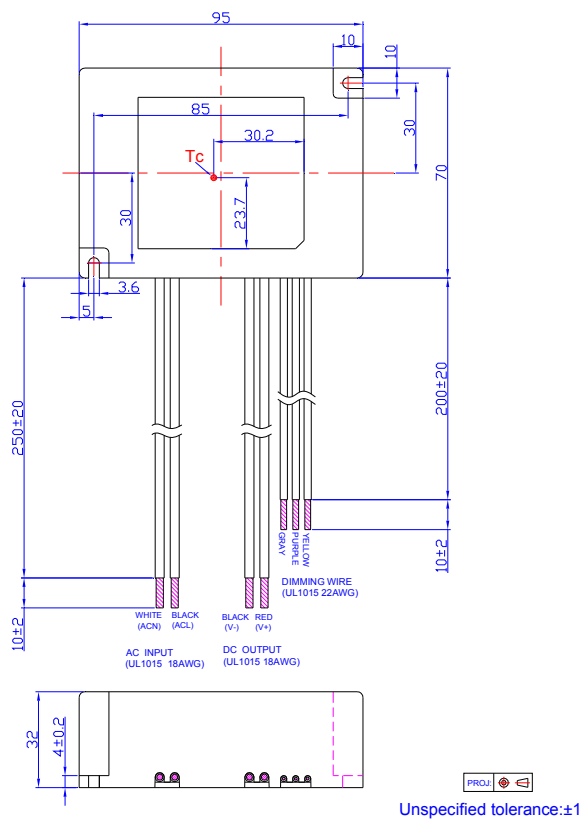

EUC-042SxxxPS

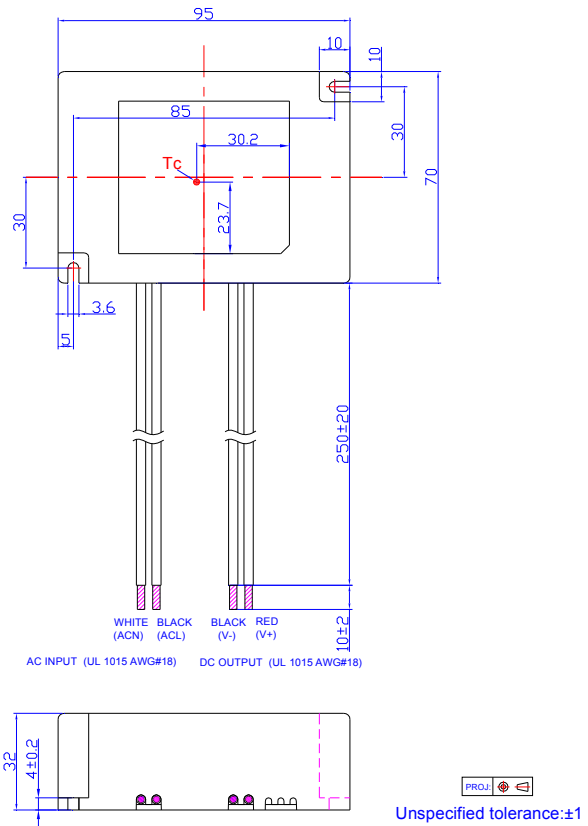

RoHS Compliance

Our products comply with the European Directive 2011/65/EC, calling for the elimination of lead and other hazardous substances from electronic products.

Revision History

Change Date	Rev.	Description of Change		
		Item	From	To
2012-02-17	A	Preliminary Datasheets First Release	/	/
2012-03-21	B	EUC-042S105DS(PS) CUL Class 2 added	/	/
2012-05-25	C	EUC-042S105DS(PS)-0001	/	Added
		EN 61000-4-5--- line to line 2 kV, line to earth 4 kV	/	Corrected
		Life time	/	50,000 Hours
		EUC-042S070DS(PS)-0001	/	Added
2012-06-06	D	EUC-042S070DS(PS)-0001, EUC-042S105DS(PS)-0001	/	Deleted
		Notes of life time	/	Updated
		Life time vs. Tc Curve	/	Added
2012-07-02	E	Description of OTP	/	Updated
2012-07-17	F	Max Case Temperature	/	Updated
2012-7-30	G	Min Operating Temperature	-20°C	-40°C
2012-08-20	H	Derating Curve	/	Updated
		Inrush Current	60A	70A
		Inrush Current(I ² t)	/	Added
		Temperature coefficient	/	Added
2012-11-16	I	Life time	Min 50,000hrs	Typical 116,000hrs
		Life time Curve	/	Updated
		Io/Ir Vs Rx Curve	/	Added
		THD Curve	/	Added
		EFF and PF Curve of other models	/	Added
2013-05-22	J	Inrush Current(I ² t) corrected	0.16 A ² s	0.32 A ² s
		Duration of Inrush Current corrected	100 μs	200 μs
		Mechanical Outline---cable length corrected	/	Updated
2013-11-25	K	Model 530mA	/	Added
		Mechanical Outline-Dimming wires updated	UL1015 26AWG	UL1015 22AWG
2014-05-27	L	ENEC certificate	/	Added

Revision History (Continued)

Change Date	Rev.	Description of Change		
		Item	From	To
2015-08-04	M	Warranty Tc	/	Added
		Environmental Specifications	/	Deleted
		Inrush Current Waveform	/	Added
		CCC certificate	/	Added
		CQC certificate	/	Deleted
		Source Current on 0~10V Input Pin Max.	200 uA	250 uA
2015-12-31	N	KS Certification	/	Added
		KC Certification-EUC-042S070/105/128/140DS(PS)	/	Added
		Net Weight	350 g	390 g
2016-04-18	O	UL Type TL	/	Added
		KS Certificate Regulation	/	Added
		Note of EMI Standard	/	Added
2016-08-02	P	Turn-on Delay Time at 120Vac	Max.=1.0 s	Max.=0.75 s
2019-04-17	Q	Mechanical Outline	/	Updated