



SPECIFICATION FOR APPROVAL

Customer : FANCOOL

Description : DC FAN

Customer Part No. _____ REV. : _____

Delta Model No. : KDB0305HA3-00G3H REV. : X00

Sample Issue No. : _____

Sample Issue Date : NOV.05 2019

PLEASE SEND ONE COPY OF THIS SPECIFICATION BACK AFTER YOU SIGNED APPROVAL FOR PRODUCTION PRE-ARRANGMENT.

APPROVED BY:

DATE :

DELTA ELECTRONICS, INC.
TAOYUAN PLANT
252, SHANG YING ROAD, KUEI SAN INDUSTRIAL ZONE
TAOYUAN SHIEN, TAIWAN, R.O.C.
TEL:886-(0)3-3591968
FAX:886-(0)3-3591991

Delta Electronics, Inc.
No.252, Shanying Rd., Guishan Dist.,
Taoyuan City 333, Taiwan (R.O.C.)

TEL : 886-(0)3-3591968
FAX : 886-(0)3-3591991

STATEMENT OF DEVIATION

NONE

DESCRIPTION:

Delta Electronics, Inc.
 No.252, Shanying Rd., Guishan Dist.,
 Taoyuan City 333, Taiwan (R.O.C.)

TEL : 886-(0)3-3591968
 FAX : 886-(0)3-3591991

Specification For Approval

Customer : FANCOOL

Description : DC FAN

Customer P/N : _____	rev. : _____
Delta model no. : KDB0305HA3-00G3H	Delta Safety Model No.: KDB0305HA3-00
Sample revision. : X00	Issue no.: _____
Sample issue date : NOV.05 2019	Quantity : _____

1. SCOPE:

THIS SPECIFICATION DEFINES THE ELECTRICAL AND MECHANICAL CHARACTERISTICS OF THE DC BRUSHLESS BLOWER FLOW FAN.

2. CHARACTERS:

ITEM	DESCRIPTION
RATED VOLTAGE	5.0V
OPERATION VOLTAGE	4.5 - 5.5 VDC
INPUT CURRENT(AVG.) #	0.35 (MAX 0.50) A SAFETY CURRENT ON LABEL: 0.50A
INPUT POWER(AVG.)	0.35 (MAX 0.50) W
SPEED	12500±10%R.P.M.
MAX. AIR FLOW (AT ZERO STATIC PRESSURE)	0.027 (MIN. 0.024) M ³ /MIN. 0.950 (MIN. 0.855) CFM
MAX. AIR PRESSURE (AT ZERO AIRFLOW)	24.02 (MIN. 19.46) mmH ₂ O 0.946 (MIN. 0.766) inchH ₂ O
ACOUSTICAL NOISE (AVG.) TEST DISTANCE : 0.3M	42.0 (MAX. 46.0) dB-A
INSULATION TYPE	UL: CLASS A
INSULATION STRENGT	10 MEG OHM MIN. AT 500 VDC (BETWEEN FRAME AND (+) TERMINAL)
DIELECTRIC STRENGTH	5 mA MAX. AT 500 VAC 50/60 Hz ONE MINUTE, (BETWEEN FRAME AND (+) TERMINAL)

THE MAX VALUE OF CONSUMING CURRENT DOES NOT REPRESENT THE PEAK VALUE
 THE PEAK VALUE NEED MEASURE BY OSCILLOSCOPE.

(continued)

PART NO:

DELTA MODEL: KDB0305HA3-00G3H

LIFE EXPECTANCE (L10) (AT LABEL VOLTAGE)	30,000 HOURS CONTINUOUS OPERATION AT 40 %%DC WITH 15 ~ 65 %%%RH.
ROTATION	CLOCKWISE VIEW FROM NAME PLATE SIDE
LOCKED PROTECTION	THE FAN WILL SHUT DOWN WHEN ROTOR LOCKED .

NOTES:

1. ALL READINGS ARE MEASURED AFTER STABLY WARMING UP THROUGH 10 MINUTES.
2. STANDARD AIR PROPERTY IS AIR AT (Td) 25°C TEMPERATURE, (RH) 65% RELATIVE HUMIDITY , AND (Pb) 760 mmHg BAROMETRIC PRESSURE.
3. THE VALUES WRITTEN IN PARENS , (), ARE LIMITED SPEC.
4. ACOUSTICAL NOISE MEASURING CONDITION:

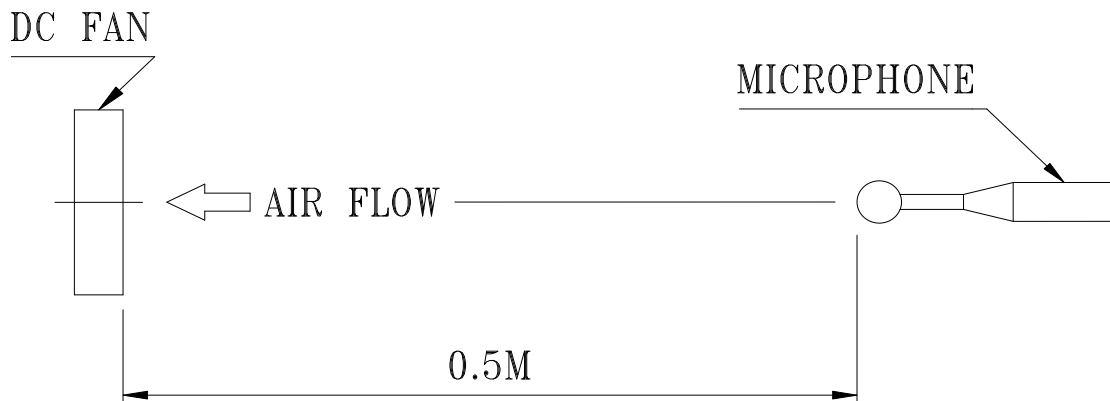

NOISE IS MEASURED AT RATED VOLTAGE IN FREE AIR IN ANECHOIC CHAMBER WITH B & K SOUND LEVEL METER WITH MICROPHONE AT A DISTANCE OF ONE METER FROM THE FAN INTAKE.

PART NO:

DELTA MODEL: KDB0305HA3-00G3H

3. MECHANICAL:

- 3-1. DIMENSIONS----- SEE DIMENSIONS DRAWING
- 3-2. FRAME----- PLASTIC UL: 94V-0
(THE CONTACT OF HALOGEN LESS THAN 1500 PPM FOR USING EDX ...ETC)
- 3-3. IMPELLER----- PLASTIC UL: 94V-0
(THE CONTACT OF HALOGEN LESS THAN 1500 PPM FOR USING EDX ...ETC)
- 3-4. BEARING SYSTEM----- FDB BEARING
- 3-5. WEIGHT----- 5.2 GRAMS(REF.)

4. ENVIRONMENTAL:

- 4-1. OPERATING TEMPERATURE----- -10 TO +60 DEGREE C
- 4-2. STORAGE TEMPERATURE----- -40 TO +75 DEGREE C
- 4-3. OPERATING HUMIDITY----- 5 TO 90 % RH
- 4-4. STORAGE HUMIDITY----- 5 TO 95 % RH

5. PROTECTION:

- 5-1. LOCKED ROTOR PROTECTION
IMPEDANCE OF MOTOR WINDING PROTECTS MOTOR FROM FIRE IN
96 HOURS OF LOCKED ROTOR CONDITION AT THE RATED VOLTAGE.

6. RE OZONE DEPLETING SUBSTANCES:

- 6-1. NO CONTAINING PBBs, PBBOs, CFCs, PBBEs, PBDPEs AND HCFCs.

7. PRODUCTION LOCATION

- 7-1. PRODUCTS WILL BE PRODUCED IN CHINA OR THAILAND.

PART NO:

DELTA MODEL: KDB0305HA3-00G3H

8. P & Q CURVE:

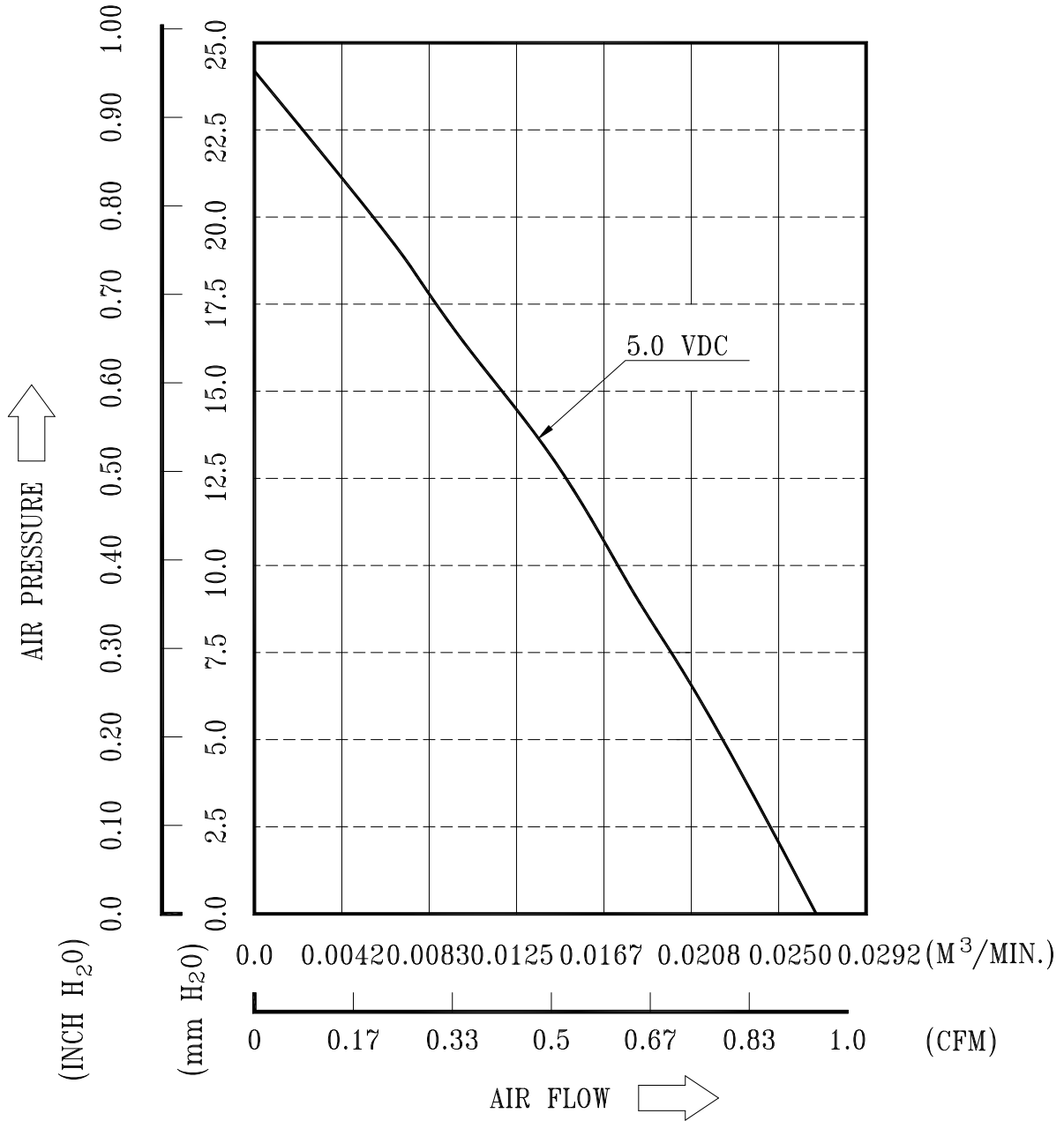

* TEST CONDITION: INPUT VOLTAGE ----- OPERATION VOLTAGE
TEMPERATURE ----- ROOM TEMPERATURE
HUMIDITY ----- 65%RH

PART NO:

DELTA MODEL: KDB0305HA3-00G3H

9. DIMENSION DRAWING:

LABEL:

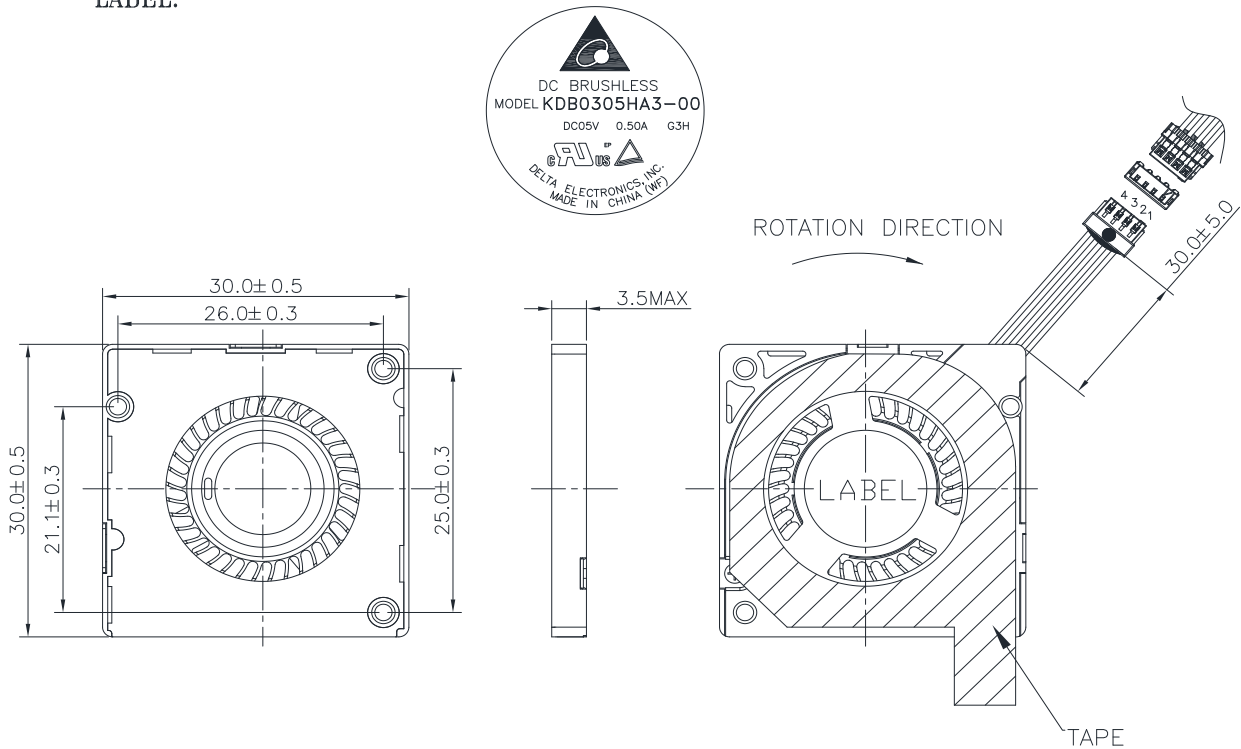

NOTES :

1. HOUSING: JST 04SUR-32S OR ACES 50375-0041N-001 (OR EQUIVALENT)
LEAD WIRE: UL10064 AWG#32
PIN 1: RED WIRE---(+)
PIN 2: BLACK WIRE---(-)
PIN 3: BLUE WIRE---(F00)
PIN 4: YELLOW WIRE---(PWM)
2. HOUSING: ACES 50375-0041N-001 OR EQUIVALENT
3. THIS PRODUCT IS RoHS COMPLIANT.
4. DELTA'S RESTRICTIONS ON HALOGEN APPLY ONLY TO BROMINATED AND CHLORINATED COMPOUNDS. NO OTHER HALOGEN IS RESTRICTED. SUBSTANCES RESTRICTIONS FOR HALOGEN-FREE(INCLUDE FAN PLASTIC PARTS, PWB BOARD, IC, ELECTRICAL MATERIALS & CABLE ASSY),
 - a. BROMINE(Br) < 900 PPM,
 - b. CHLORINE(Cl) < 900 PPM
 - c. (Br) + (Cl) < 1500 PPM.

PART NO:

DELTA MODEL: KDB0305HA3-00G3H

10.FREQUENCY GENERATOR (FG) SIGNAL:

10-1. OUTPUT CIRCUIT - OPEN DRAIN MODE:

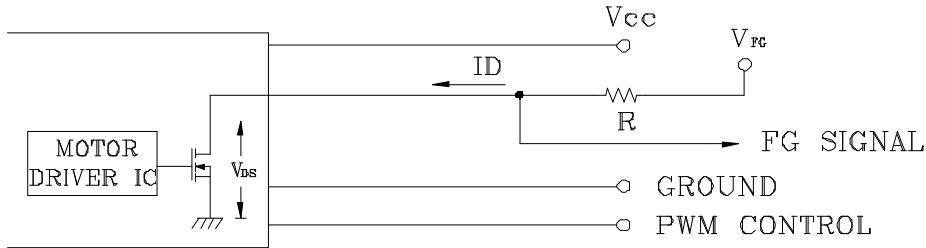

CAUTION:

THE FG SIGNAL LEAD WIRE MUST BE KEPT AWAY FROM "+" LEAD WIRE & "-" LEAD WIRE.

10-2. SPECIFICATION:

$V_{FG} = 5.0V$ TYP. (V_{CC} MAX.)

$I_D = 5mA$ MAX.

$R \geq V_{FG} / I_D$

THE RESISTOR R IS NOT INCLUDED IN FAN CIRCUIT AND NEEDS TO BE PROVIDED BY FAN USER

10-3. FREQUENCY GENERATOR WAVEFORM:

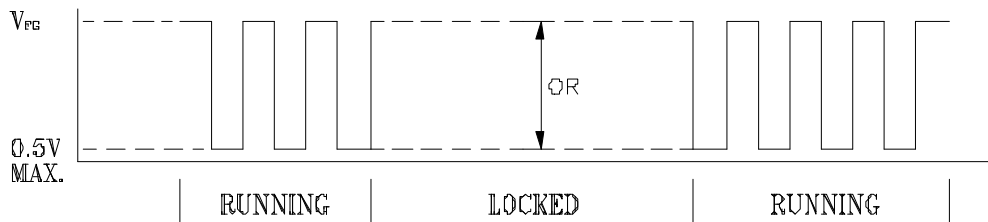

FAN RUNNING FOR 4 POLES

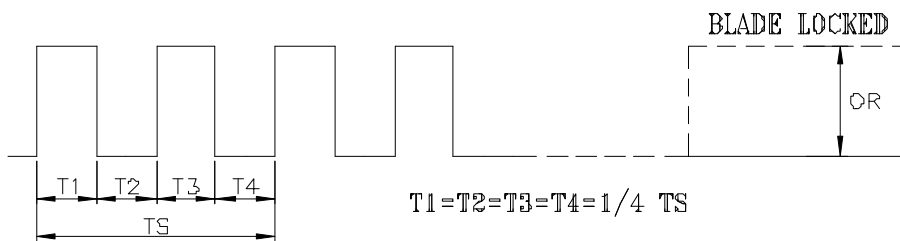

$N = R.P.M$

$TS = 60/N(SEC)$

PART NO:

DELTA MODEL: KDB0305HA3-00G3H

11. PWM CONTROL FUNCTION

11-1. PWM CONTROL INTERFACE

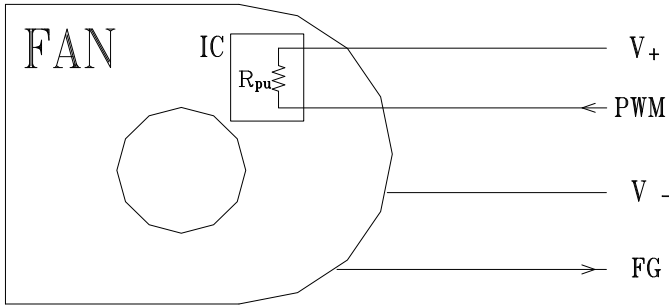

SIGNAL VOLTAGE RANGE: 0 ~ (V₊ - 0.5) VDC

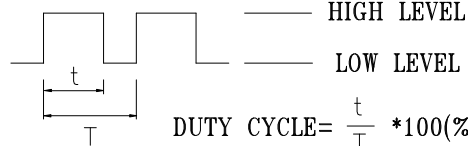

$$\text{DUTY CYCLE} = \frac{t}{T} * 100(\%)$$

$$\text{Frequency} = \frac{1}{T}$$

- HIGH LEVEL : (V₊ - 0.5) VDC max.
2.8 VDC min.
- LOW LEVEL : 0.6 VDC max.
0 VDC min.
- R_{pu} : 200Kohm ~ 500Kohm.

- THE R_{pu} IS A SEMICONDUCTING RESISTOR BUILT IN THE IC WAFER OF THE FAN DRIVER FOR THE DEFAULT SETTING.
- THE FREQUENCY FOR CONTROL SIGNAL OF THE FAN SHALL BE ABLE TO ACCEPT A 20KHZ~50KHZ.
- THE PREFERRED OPERATING FREQUENCY OF PWM SIGNAL IS 25KHZ.
- AT 100% DUTY CYCLE, THE ROTOR WILL SPIN AT MAXIMUM SPEED.
- AT 0% DUTY CYCLE, THE ROTOR WILL STOP TO SPIN.
- DUE TO PULL UP RESISTOR(R_{pu}), WHEN THE PWM CONTROL LEAD WIRE IS DISCONNECTED, THE ROTOR WILL SPIN AT MAXIMUM SPEED.

11-2. THE REQUIREMENT OF WAVEFORM QUALITY OF PWM SIGNAL

- THE RECOMMENDED PWM SIGNAL FROM SYSTEM IS TTL (t_r=50ns, t_f=50ns), EVEN IF THE PWM LEAD OF FAN IS DISCONNECTED.
- THE MAXIMUM PERMISSIBLE OF WAVEFORM DISTORTION:

$$V_{IH} : (V_+ - 0.5) \times 90\% \quad \text{RISE TIME} : t_r < 500\text{ns}$$

$$V_{IL} : (V_+ - 0.5) \times 10\% \quad \text{FALL TIME} : t_f < 500\text{ns}$$

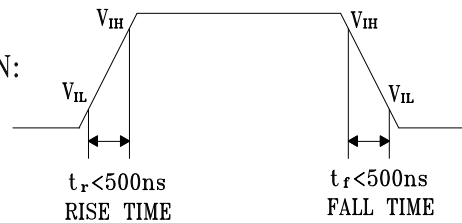

11-3. FAN CHARACTERISTICS

TEST CONDITION : AT 25°C, V⁺ = 5.0VDC & PWM SIGNAL AS FOLLOW

DUTY CYCLE (%)	SPEED R.P.M.	CURRENT (A) TYP.
100	12500±10%	0.35(A)
0	0	0.2(mA)

* PWM SIGNAL
PWM FREQUENCY = 25 KHz

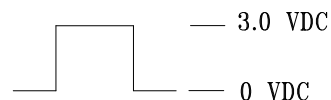

- MIN. STARTED DUTY CYCLE : 30%
WHEN DUTY CYCLE IS SET FOR MORE THAN 30% , THE FAN WILL BE ABLE TO START FROM A DEAD STOP.

PART NO:

DELTA MODEL: KDB0305HA3-00G3H

12. TYPICAL STARTUP SEQUENCE (CONDITION: 25°C, 5.0VDC, 1 ATM)

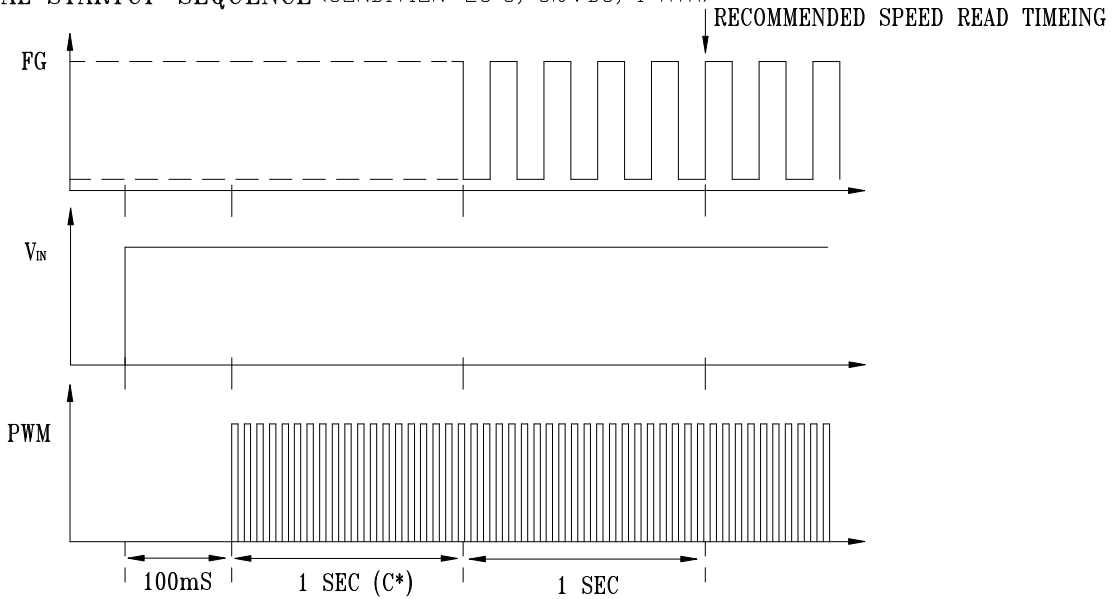

- THE FIRST 100mS IS USED TO WAIT FOR VCC SETTLING.
- THE PWM SIGNAL CAN NOT INPUT BEFORE VCC.

13. DEFINITION OF LOCK DETECTION, LOCK-OFF TIME, AND QUICK START FUNCTION

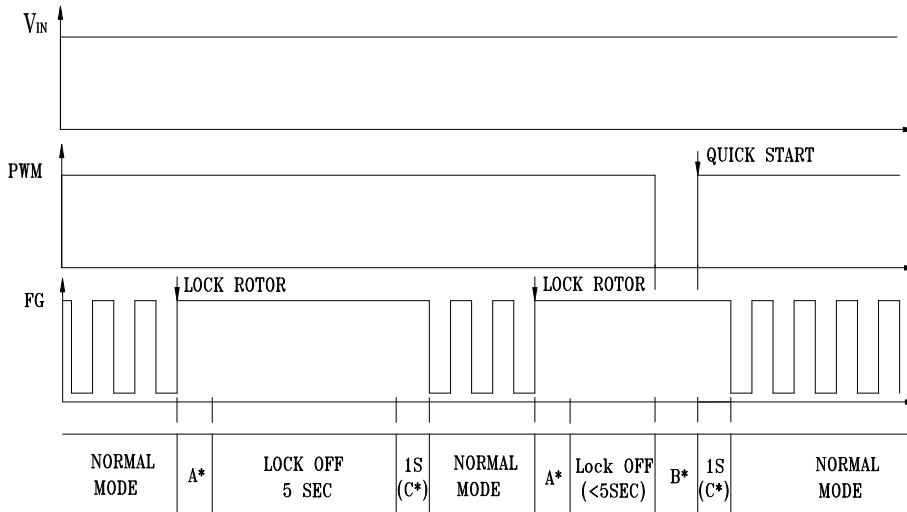

A* : TYPICALLY 0.5 SEC FOR LOCK DETECTION.

B* : COMMONLY 100mS DETECTION TIME FOR LOCK-OFF RELEASE.

C* : FG OUTPUT DELAY TIME.

- THE 5SEC LOCK-OFF TIME IS ALSO A TYPICAL VALUE AND THE MAXIMUM TOLERANCE IS 10 SECONDS.



Application Notice

- 1. Delta will not guarantee the performance of the products if the application condition falls outside the parameters set forth in the specification.**
- 2. A written request should be submitted to Delta prior to approval if deviation from this specification is required.**
- 3. Please exercise caution when handling fans. Damage may be caused when pressure is applied to the impeller, if the fans are handled by the lead wires, or if the fan was hard-dropped to the production floor.**
- 4. Except as pertains to some special designs, there is no guarantee that the products will be free from any such safety problems or failures as caused by the introduction of powder, droplets of water or encroachment of insect into the hub.**
- 5. The above-mentioned conditions are representative of some unique examples and viewed as the first point of reference prior to all other information.**
- 6. It is very important to establish the correct polarity before connecting the fan to the power source. Positive (+) and Negative (-). Damage may be caused to the fans if connection is with reverse polarity, if there is no foolproof method to protect against such error specifically mentioned in this spec.**
- 7. Delta fans without special protection are not suitable where any corrosive fluids are introduced to their environment.**
- 8. Please ensure all fans are stored according to the storage temperature limits specified. Do not store fans in a high humidity environment. We highly recommend performance testing is conducted before shipping, if the fans have been stored over 6 months.**
- 9. Not all fans are provided with the Lock Rotor Protection feature. If you impair the rotation of the impeller for the fans that do not have this function, the performance of those fans will lead to failure.**
- 10. Please be cautious when mounting the fan. Incorrect mounting of fans may cause excess resonance, vibration and subsequent noise.**
- 11. It is important to consider safety when testing the fans. A suitable fan guard should be fitted to the fan to guard against any potential for personal injury.**
- 12. Except where specifically stated, all tests are carried out at room (ambient) temperature and relative humidity conditions of 25°C, 65% RH. The test value is only for fan performance itself.**
- 13. Be certain to connect an “ 4.7μF or greater” capacitor to the fan externally when the application calls for using multiple fans in parallel, to avoid any unstable power.**