

Features

- Ultra High Efficiency (Up to 94%)
- Full Power at Wide Output Current Range (Constant Power)
- Thermal Sensing and Protection for LED Module
- 0-10V/PWM/3-Timer-Modes Dimmable
- Dim-to-Off with Standby Power ≤ 0.5 W
- Always-on Auxiliary Power: 12Vdc, 200mA
- Output Lumen Compensation
- Input Surge Protection: DM 6kV, CM 10kV
- All-Around Protection: OVP, SCP, OTP
- IP67 and UL Dry / Damp / Wet Location
- SELV Output
- TYPE HL, for use in a Class I, Division 2 hazardous (Classified) location
- 7 Years Warranty



Description

The EUD-320SxxxDT series is a 320W, constant-current, programmable LED driver that operates from 90-305 Vac input with excellent power factor. Created for many lighting applications including high bay, high mast, aquaculture and sports, etc, it provides a dim-to-off mode with low standby power. The high efficiency of these drivers and compact metal case enables them to run cooler, significantly improving reliability and extending product life. To ensure trouble-free operation, protection is provided against input surge, output over voltage, short circuit, and over temperature.

Models

Adjustable Output Current Range	Full-Power Current Range (1)	Default Output Current	Input Voltage Range(2)	Output Voltage Range	Max. Output Power	Typical Efficiency (3)	Power Factor		Model Number
							120Vac	220Vac	
105-1500mA	1050-1500mA	1400 mA	90~305 Vac/ 127~300 Vdc	107~305Vdc	320 W	94.0%	0.99	0.96	EUD-320S150DT
154-2200mA	1540-2200mA	2100 mA	90~305 Vac/ 127~300 Vdc	73~208Vdc	320 W	93.5%	0.99	0.96	EUD-320S220DT
224-3200mA	2240-3200mA	2800 mA	90~305 Vac/ 127~300 Vdc	50~143Vdc	320 W	93.5%	0.99	0.96	EUD-320S320DT
322-4600mA	3220-4600mA	4200 mA	90~305 Vac/ 127~300 Vdc	35~100Vdc	320 W	93.5%	0.99	0.96	EUD-320S460DT ⁽⁴⁾
469-6700mA	4690-6700mA	6700 mA	90~305 Vac/ 127~300 Vdc	24 ~ 68Vdc	320 W	93.5%	0.99	0.96	EUD-320S670DT ⁽⁴⁾

- Notes:** (1) Output current range with constant power at 320W
 (2) Certified input voltage range: UL, FCC 100-277Vac or 127-300Vdc; otherwise 100-240Vac or 127-250Vdc
 (3) Measured at 100% load and 220Vac input (see below "General Specifications" for details).
 (4) SELV output

I-V Operating Area

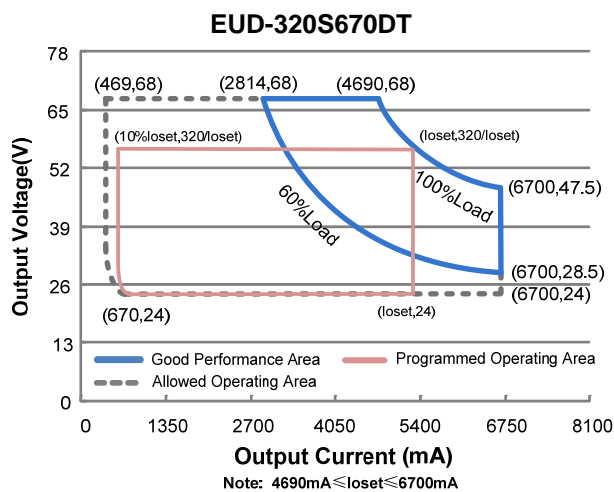
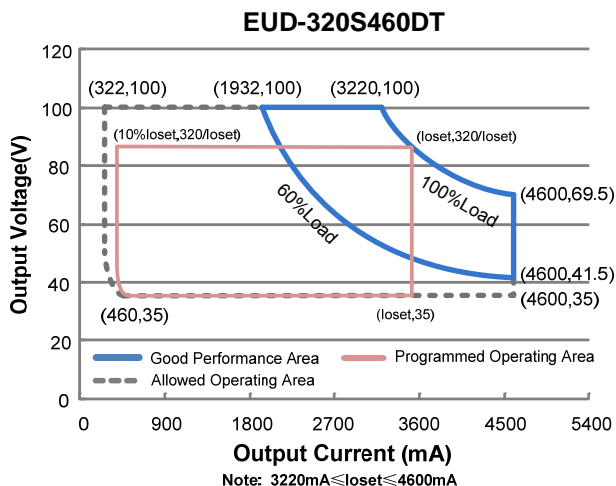
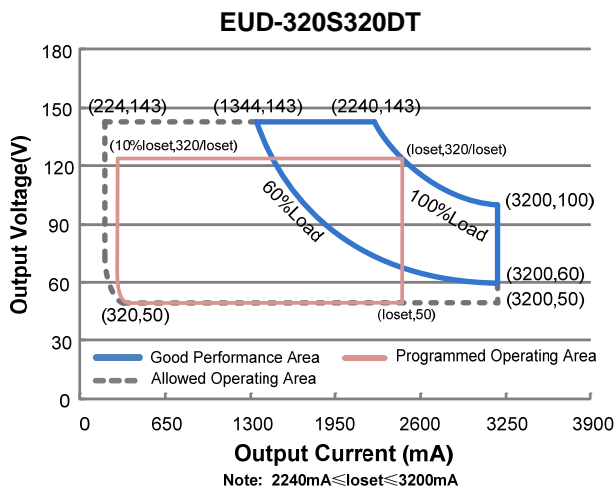
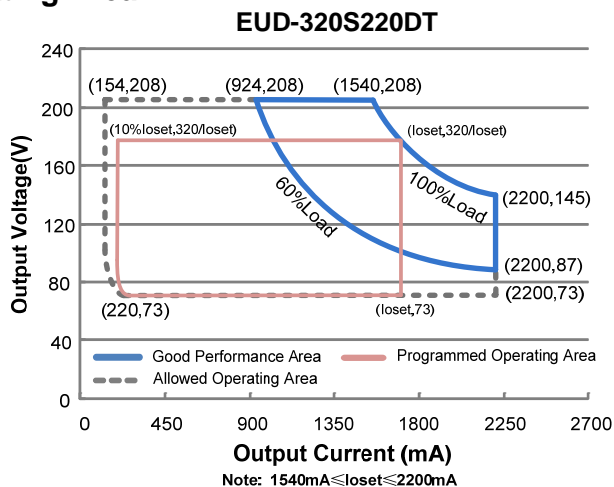
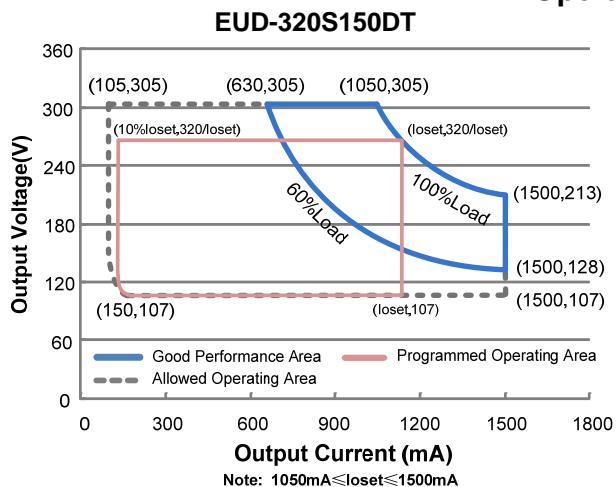

Input Specifications

Parameter	Min.	Typ.	Max.	Notes
Input Voltage	90 Vac	-	305 Vac	127~300 Vdc
Input Frequency	47 Hz	-	63 Hz	
Leakage Current	-	-	0.75 MIU	UL8750; 277Vac/ 60Hz, grounding effectively
	-	-	0.70 mA	IEC60598-1; 240Vac/ 60Hz, grounding effectively
Input AC Current	-	-	3.30 A	Measured at 100% load and 120Vac input.
	-	-	1.80 A	Measured at 100% load and 220Vac input.
Inrush Current(I ² t)	-	-	1.90 A ² s	At 220Vac input, 25°C Cold Start, Duration=3.52 ms, 10%I _{pk} -10%I _{pk} . See Inrush Current Waveform for the details.
PF	0.90	-	-	At 100-277Vac, 50-60Hz, 60%-100% Load (192-320W)
THD	-	-	20%	
THD	-	-	10%	At 220-240Vac, 50-60Hz, 75%-100% Load (240-320W)

Output Specifications

Parameter	Min.	Typ.	Max.	Notes
Output Current Tolerance	-5%loset	-	5%loset	At 100% load condition
Output Current Setting(loset) Range				
EUD-320S150DT	105 mA	-	1500 mA	
EUD-320S220DT	154 mA	-	2200 mA	
EUD-320S320DT	224 mA	-	3200 mA	
EUD-320S460DT	322 mA	-	4600 mA	
EUD-320S670DT	469 mA	-	6700 mA	
Output Current Setting Range with Constant Power				
EUD-320S150DT	1050 mA	-	1500 mA	
EUD-320S220DT	1540 mA	-	2200 mA	
EUD-320S320DT	2240 mA	-	3200 mA	
EUD-320S460DT	3220 mA	-	4600 mA	
EUD-320S670DT	4690 mA	-	6700 mA	
Total Output Current Ripple (pk-pk)	-	5%lomax	10%lomax	At 100% load condition, 20 MHz BW
Output Current Ripple at < 200 Hz (pk-pk)	-	2%lomax	-	At 100% load condition. Only this component of ripple is associated with visible flicker.
Startup Overshoot Current	-	-	10%lomax	At 100% load condition
No Load Output Voltage				
EUD-320S150DT	-	-	350 V	
EUD-320S220DT	-	-	240 V	
EUD-320S320DT	-	-	160 V	
EUD-320S460DT	-	-	115 V	
EUD-320S670DT	-	-	78 V	
Line Regulation	-	-	±0.5%	Measured at 100% load
Load Regulation	-	-	±1.5%	

Output Specifications (Continued)

Parameter	Min.	Typ.	Max.	Notes
Turn-on Delay Time	-	-	1.0 s	Measured at 120Vac input, 60%-100% Load
	-	-	0.5 s	Measured at 220Vac input, 60%-100% Load
Temperature Coefficient of I _o set	-	0.03%/°C	-	Case temperature = 0°C ~T _c max
12V Auxiliary Output Voltage	10.8 V	12 V	13.2 V	
12V Auxiliary Output Source Current	0 mA	-	200 mA	Return terminal is "Dim"

Note: All specifications are typical at 25°C unless otherwise stated.

General Specifications

Parameter	Min.	Typ.	Max.	Notes
Efficiency at 120 Vac input:				
EUD-320S150DT				
I _o =1050mA	89.5%	91.5%	-	Measured at 100% load and steady-state temperature in 25°C ambient; (Efficiency will be about 2.0% lower if measured immediately after startup.)
I _o =1500mA	88.0%	90.0%	-	
EUD-320S220DT				
I _o =1540mA	89.5%	91.5%	-	
I _o =2200mA	88.5%	90.5%	-	
EUD-320S320DT				
I _o =2240mA	89.5%	91.5%	-	
I _o =3200mA	87.5%	89.5%	-	
EUD-320S460DT				
I _o =3220mA	89.0%	91.0%	-	
I _o =4600mA	87.5%	89.5%	-	
EUD-320S670DT				
I _o =4690mA	89.0%	91.0%	-	
I _o =6700mA	87.5%	89.5%	-	
Efficiency at 220 Vac input:				
EUD-320S150DT				
I _o =1050mA	92.0%	94.0%	-	Measured at 100% load and steady-state temperature in 25°C ambient; (Efficiency will be about 2.0% lower if measured immediately after startup.)
I _o =1500mA	90.5%	92.5%	-	
EUD-320S220DT				
I _o =1540mA	91.5%	93.5%	-	
I _o =2200mA	90.5%	92.5%	-	
EUD-320S320DT				
I _o =2240mA	91.5%	93.5%	-	
I _o =3200mA	90.0%	92.0%	-	
EUD-320S460DT				
I _o =3220mA	91.5%	93.5%	-	
I _o =4600mA	90.0%	92.0%	-	
EUD-320S670DT				
I _o =4690mA	91.5%	93.5%	-	
I _o =6700mA	89.5%	91.5%	-	

General Specifications (Continued)

Parameter	Min.	Typ.	Max.	Notes
Efficiency at 277 Vac input: EUD-320S150DT I _o =1050mA I _o =1500mA EUD-320S220DT I _o =1540mA I _o =2200mA EUD-320S320DT I _o =2240mA I _o =3200mA EUD-320S460DT I _o =3220mA I _o =4600mA EUD-320S670DT I _o =4690mA I _o =6700mA	92.0% 91.0% 92.0% 90.5% 92.0% 90.0% 91.5% 90.5% 91.5% 90.0%	94.0% 93.0% 94.0% 92.5% 94.0% 92.0% 93.5% 92.5% 93.5% 92.0%	- - - - - - - - - -	Measured at 100% load and steady-state temperature in 25°C ambient; (Efficiency will be about 2.0% lower if measured immediately after startup.)
Standby power	-	-	0.5 W	Measured at 230Vac/50Hz; Dimming off
MTBF	-	237,000 Hours	-	Measured at 220Vac input, 80%Load and 25°C ambient temperature (MIL-HDBK-217F)
Lifetime	-	97,000 Hours	-	Measured at 220Vac input, 80%Load and 70°C case temperature; See lifetime vs. T _c curve for the details
Operating Case Temperature for Safety T _{c_s}	-40°C	-	+89°C	
Operating Case Temperature for Warranty T _{c_w}	-40°C	-	+75°C	Case temperature for 7 years warranty. <i>Please see Inventronics Warranty Statement for complete details.</i>
Storage Temperature	-40°C	-	+85°C	Humidity: 5%RH to 100%RH
Dimensions Inches (L × W × H) Millimeters (L × W × H)		8.86 × 3.86 × 1.75 225 × 98 × 44.8		With mounting ear 9.88 × 3.86 × 1.75 251 × 98 × 44.8
Net Weight	-	1875 g	-	

Note: All specifications are typical at 25°C unless otherwise stated.

Dimming Specifications

Parameter	Min.	Typ.	Max.	Notes	
Absolute Maximum Voltage on the V _{dim} (+) Pin	-20 V	-	20 V		
Source Current on V _{dim} (+)Pin	200 μA	300 μA	450 μA	V _{dim} (+) = 0 V	
Dimming Output Range	EUD-320S150DT EUD-320S220DT EUD-320S320DT EUD-320S460DT EUD-320S670DT	10%I _o set	-	I _o set	1050mA ≤ I _o set ≤ 1500mA 1540mA ≤ I _o set ≤ 2200mA 2240mA ≤ I _o set ≤ 3200mA 3220mA ≤ I _o set ≤ 4600mA 4690mA ≤ I _o set ≤ 6700mA
	EUD-320S150DT EUD-320S220DT EUD-320S320DT EUD-320S460DT EUD-320S670DT	105mA 154mA 224mA 322mA 469mA	-	I _o set	105mA ≤ I _o set < 1050mA 154mA ≤ I _o set < 1540mA 224mA ≤ I _o set < 2240mA 322mA ≤ I _o set < 3220mA 469mA ≤ I _o set < 4690mA

Dimming Specifications (Continued)

Parameter	Min.	Typ.	Max.	Notes
Recommended Dimming Input Range	0 V	-	10 V	Default 0-10V dimming mode.
Dim off Voltage	0.35 V	0.5 V	0.65 V	
Dim on Voltage	0.55 V	0.7 V	0.85 V	
Hysteresis	-	0.2 V	-	
PWM_in High Level	3 V	-	10 V	Dimming mode set to PWM in PC interface.
PWM_in Low Level	-0.3 V	-	0.6 V	
PWM_in Frequency Range	200 Hz	-	3 KHz	
PWM_in Duty Cycle	1%	-	99%	
PWM Dimming off (Positive Logic)	3%	5%	8%	
PWM Dimming on (Positive Logic)	5%	7%	10%	
PWM Dimming off (Negative Logic)	92%	95%	97%	
PWM Dimming on (Negative Logic)	90%	93%	95%	
Hysteresis	-	2%	-	

Note: All specifications are typical at 25 °C unless stated otherwise.

Safety & EMC Compliance

Safety Category	Standard
UL/CUL	UL8750,CAN/CSA-C22.2 No. 250.13
CE	EN 61347-1, EN61347-2-13
EMI Standards	Notes
EN 55015/KN 15 ⁽¹⁾	Conducted emission Test & Radiated emission Test
EN 61000-3-2	Harmonic current emissions Class C
EN 61000-3-3	Voltage Fluctuations & Flicker
FCC Part 15 ⁽¹⁾	ANSI C63.4 Class B
	This device complies with Part 15 of the FCC Rules. Operation is subject to the following two conditions: [1] this device may not cause harmful interference, and [2] this device must accept any interference received, including interference that may cause undesired Operation.
EMS Standards	Notes
EN 61000-4-2	Electrostatic Discharge(ESD): 8kV air discharge, 4kV contact discharge
EN 61000-4-3	Radio-Frequency Electromagnetic Field Susceptibility Test-RS
EN 61000-4-4	Electrical Fast Transient/Burst-EFT

Safety & EMC Compliance (Continued)

EMS Standards	Notes
EN 61000-4-5	Surge Immunity Test: AC Power Line: Differential Mode 6 kV, Common Mode 10 kV ⁽²⁾
EN 61000-4-6	Conducted Radio Frequency Disturbances test-CS
EN 61000-4-8	Power Frequency Magnetic Field Test
EN 61000-4-11	Voltage Dips
EN 61547	Electromagnetic Immunity Requirements Applies To Lighting Equipment

- Note:** (1) This LED driver meets the EMI specifications above, but EMI performance of a luminaire that contains it depends also on the other devices connected to the driver and on the fixture itself.
- (2) To perform electric strength (hi-pot) testing, the “GDT ground disconnect” (nut and metal lock sheet) on the driver end-cap should be removed temporarily to prevent the internal gas discharge tube from conducting (as allowed by IEC 60598-1 Clause 10.2). After testing is completed, these items must be reinstalled to restore line-to-earth surge protection and secure the end cap.

Derating

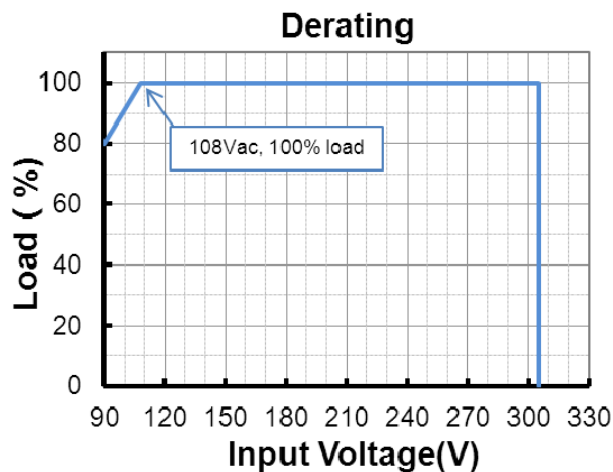

Lifetime vs. Case Temperature

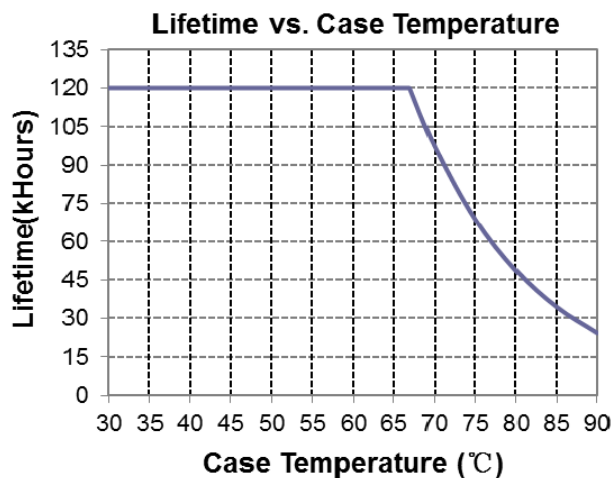

Inrush Current Waveform

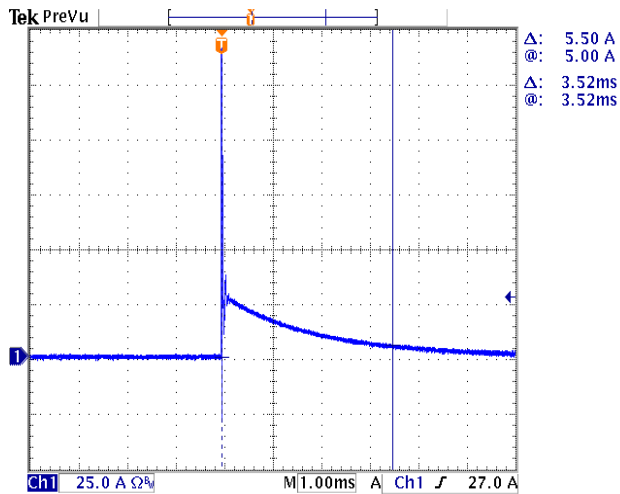

Efficiency vs. Load

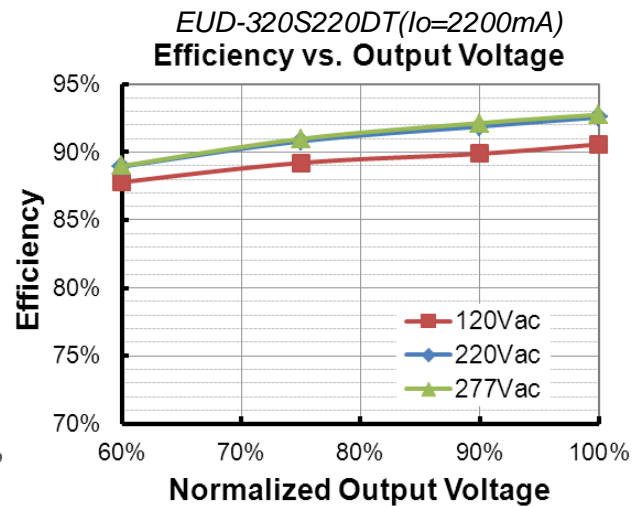
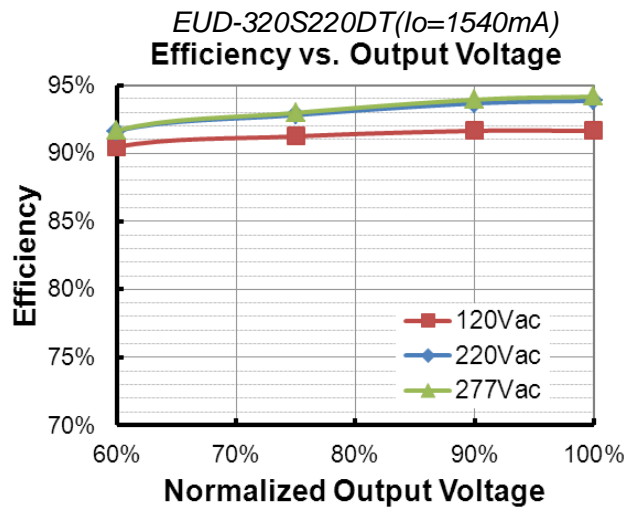
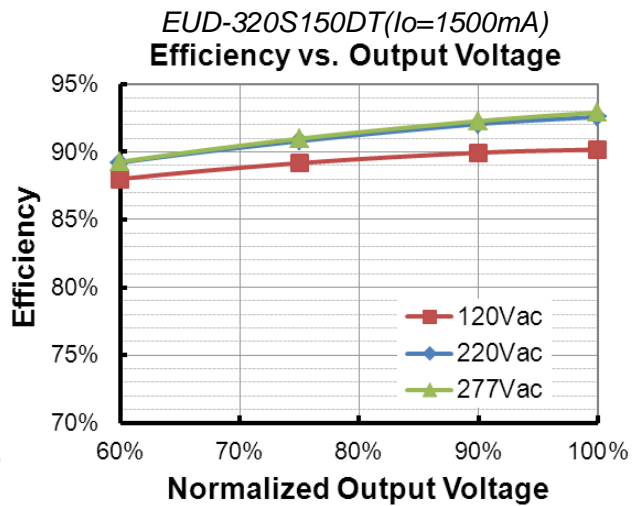
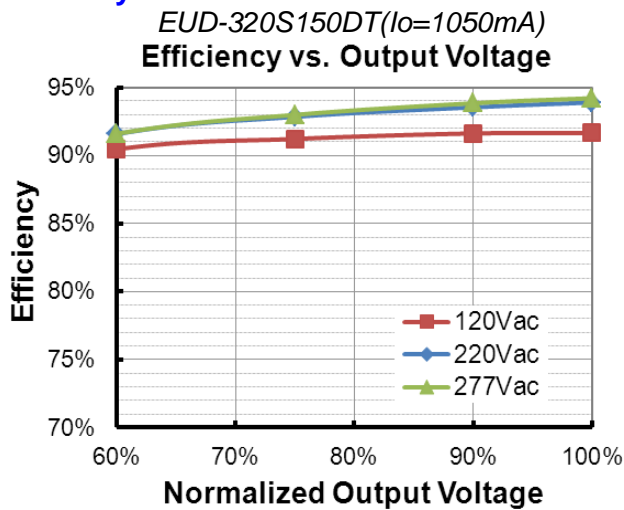

EUD-320S320DT (Io=2240mA)
Efficiency vs. Output Voltage

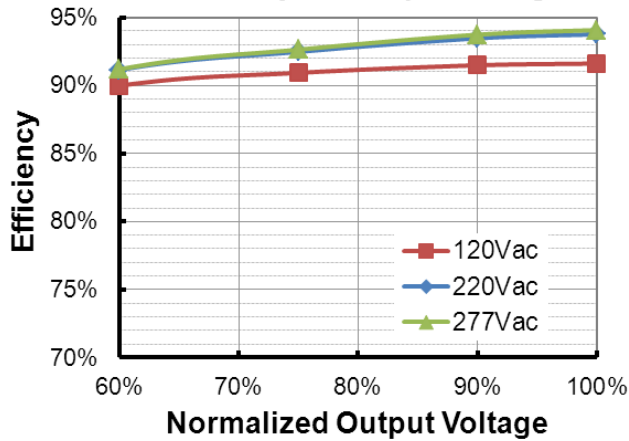

EUD-320S320DT (Io=3200mA)
Efficiency vs. Output Voltage

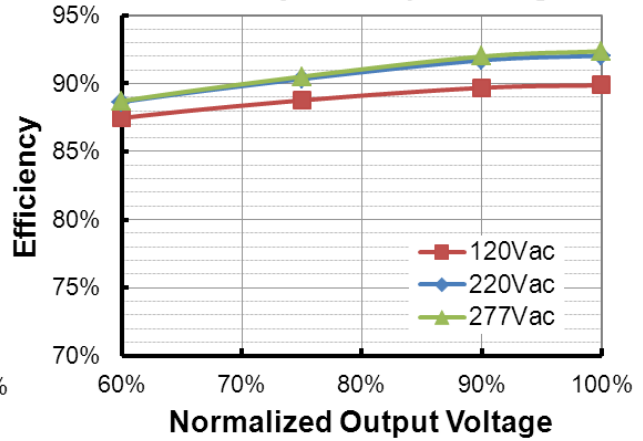

EUD-320S460DT (Io=3220mA)
Efficiency vs. Output Voltage

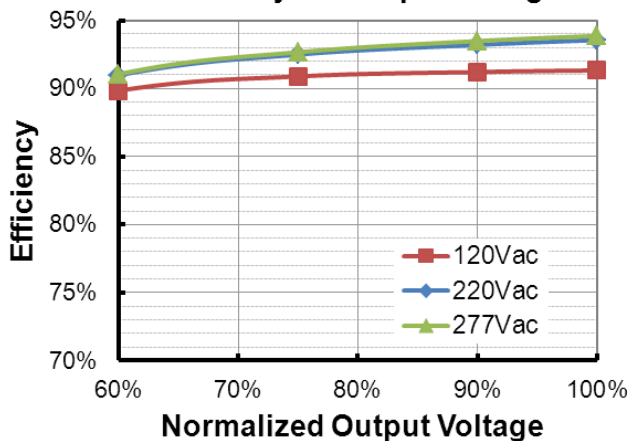

EUD-320S460DT (Io=4600mA)
Efficiency vs. Output Voltage

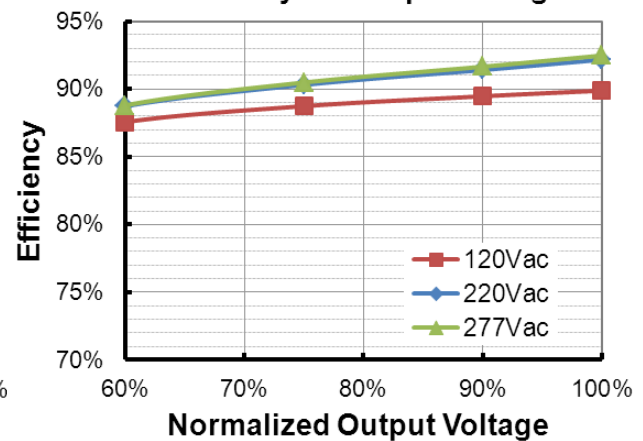

EUD-320S670DT (Io=4690mA)
Efficiency vs. Output Voltage

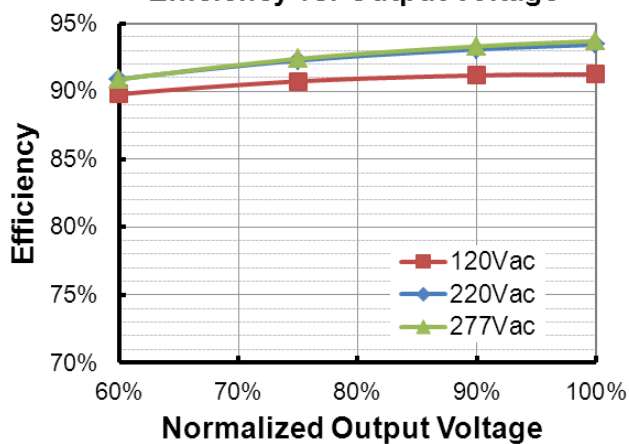

EUD-320S670DT (Io=6700mA)
Efficiency vs. Output Voltage

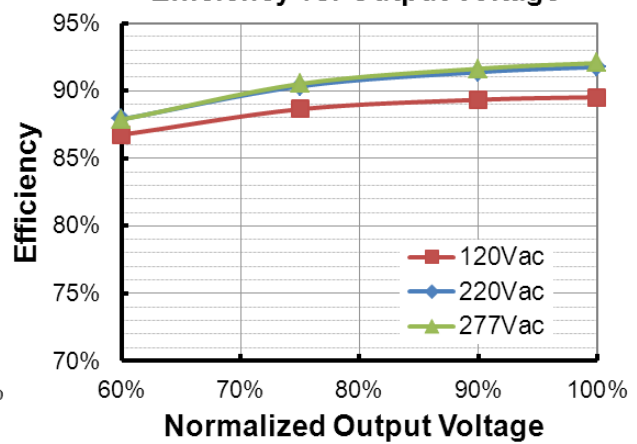

Power Factor

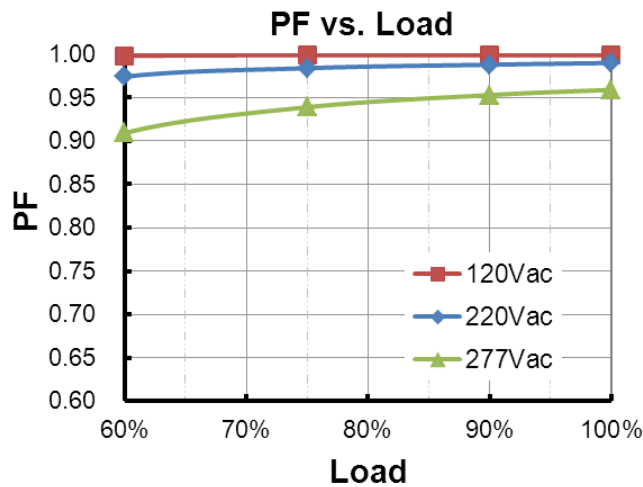

Total Harmonic Distortion

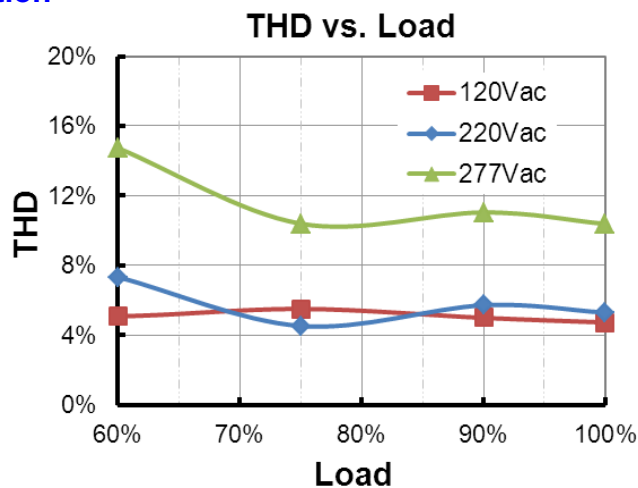

Protection Functions

Parameter		Min.	Typ.	Max.	Notes
External Thermal Protection NTC	R1	-	7.81 kOhm	-	When R_NTC falls below R1, External Thermal Protection is triggered, reducing output current until R2 is reached.
	R2	-	4.16 kOhm	-	When R_NTC is less than R2, output current is reduced to the programmed "Protection Current Floor."
	Protection Current Floor	10%loset	60%loset	100%loset	10%loset > Iomin (default setting is 60%)
		Iomin	60%loset	100%loset	10%loset ≤ Iomin (default setting is 60%)
Over Temperature Protection		Decreases output current, returning to normal after over temperature is removed.			
Short Circuit Protection		Auto Recovery. No damage will occur when any output is short circuited. The output shall return to normal when the fault condition is removed.			
Over Voltage Protection		Limits output voltage at no load and in case the normal voltage limit fails.			

Dimming

● 0-10V Dimming

The recommended implementation of the dimming control is provided below.

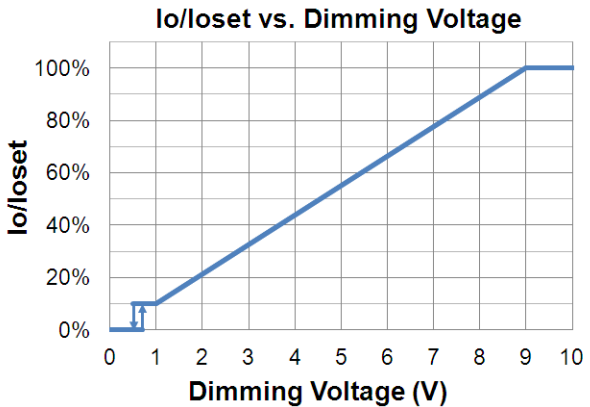
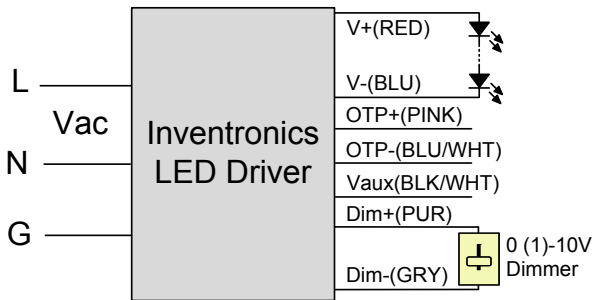

Implementation 1: DC Input

Notes:

1. The dimmer can also be replaced by an active 0-10V voltage source signal or passive components like resistors and zener.
2. Do NOT connect Dim- to the output V- or V+, otherwise the driver will not work properly.
3. If 0-10V dimming is not used, Dim + should be open.

● PWM Dimming

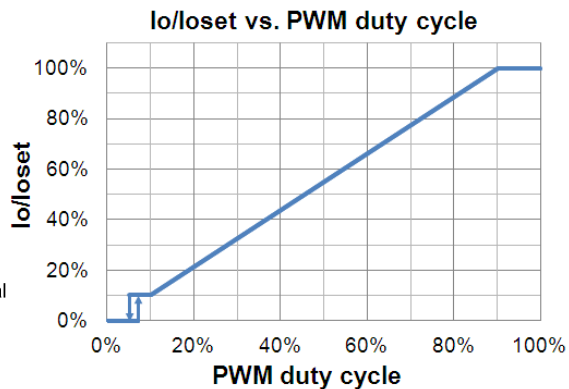
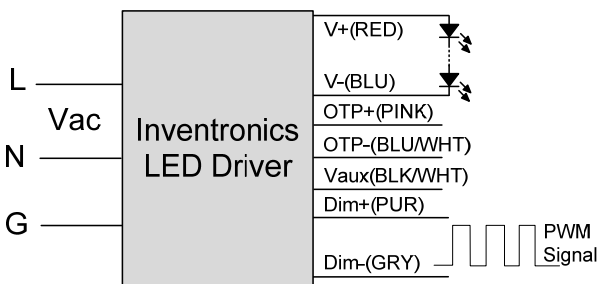

Implementation 2: Positive logic

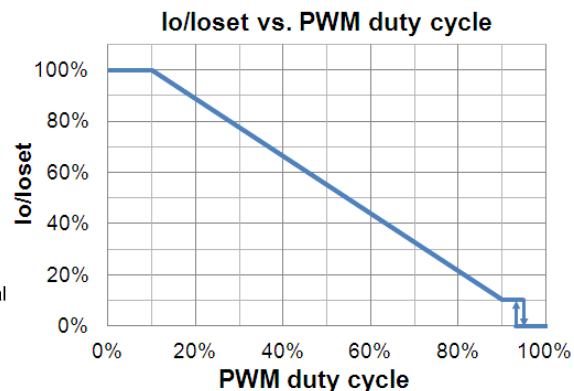
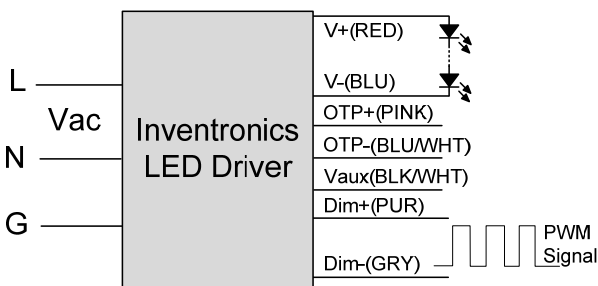

Implementation 3: Negative logic

● Time Dimming

Time dimming control includes 3 kinds of modes, they are Self Adapting-Midnight, Self Adapting-Percentage and Traditional Timer.

- **Self Adapting-Midnight:** Automatically adjusts the dimming curve based on the on-time of past two days (if difference <15 minutes), assuming that the center point of the dimming curve is midnight local time.
- **Self Adapting-Percentage:** Automatically adjusts the on-time of each step by a constant percentage = (actual on-time for the past 2 days if difference <15 min) / (programmed on-time from the dimming curve).
- **Traditional Timer:** Follows the programmed timing curve after power on with no changes.

● Output Lumen Compensation

Output Lumen Compensation (OLC) may be used to maintain constant light output over the life of the LEDs by driving them at a reduced current when new, then gradually increasing the drive current over time to counteract LED lumen degradation.

Programming Connection Diagram

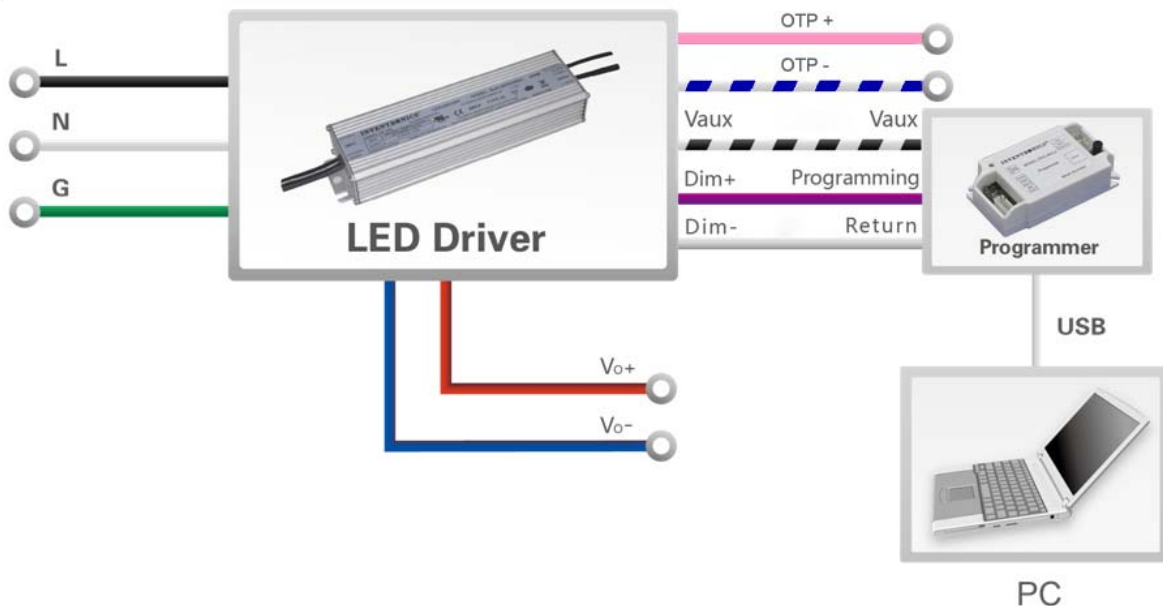

Note: The driver does not need to be powered on during the programming process.

- Please refer to [PRG-MUL2](#) (Programmer) datasheet for details.

Mechanical Outline

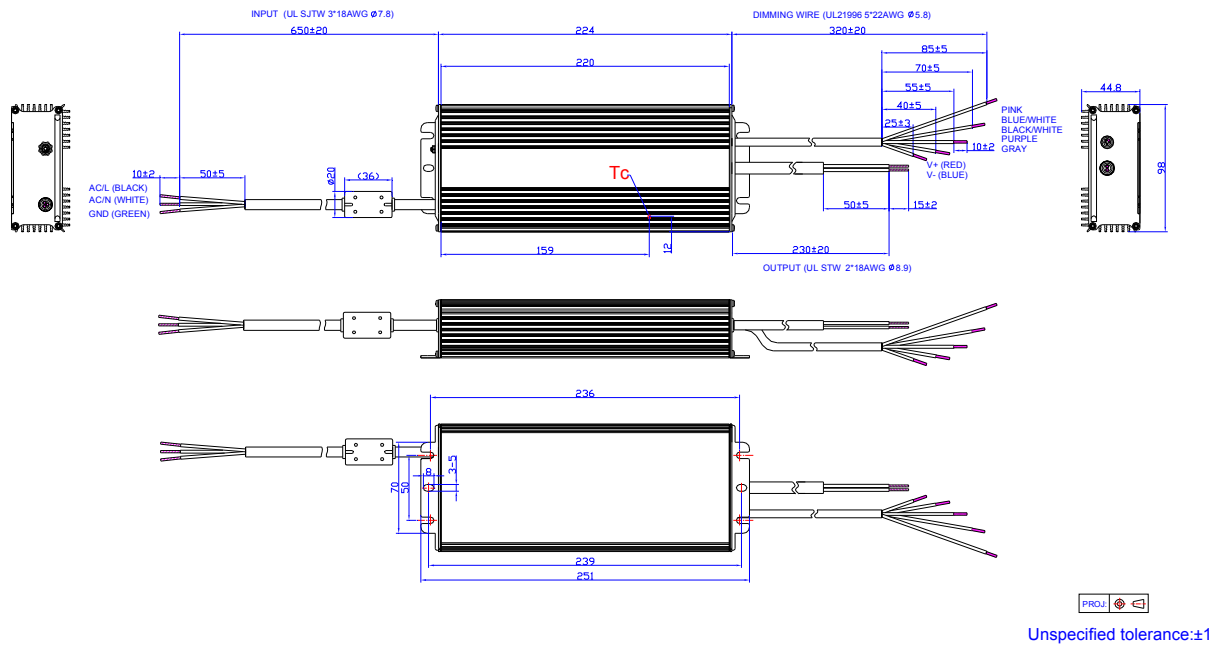

RoHS Compliance

Our products comply with reference to RoHS Directive (EU) 2015/863 amending 2011/65/EU, calling for the elimination of lead and other hazardous substances from electronic products.

Revision History

Change Date	Rev.	Description of Change		
		Item	From	To
2016-03-28	A	Datasheets Release	/	/
2017-07-31	B	Features	/	Updated
		Models	/	Updated
		Input Specifications	PF/THD	Updated
		Output Specifications	Temperature Coefficient of I _o set	Updated
		General Specifications	Dimensions	Updated
		Safety & EMC Compliance	/	Updated
		Mechanical Outline	/	Updated
2017-10-25	C	Features	Always-on Auxiliary Power	Added
		Features	7 Years Warranty	Added
		General Specifications	Operating Case Temperature for Warranty T _{c_w}	Updated
2018-01-22	D	Description	/	Updated
		General Specifications	Lifetime	Updated
		Operating Case Temperature for Warranty T _{c_w}	+70°C	+75°C
		Lifetime vs. Case Temperature	/	Updated
2019-10-16	E	KCC Logo	/	Added
		Features	Timer Dimmable (3 Timer Modes)	3-Timer-Modes Dimmable
		Features	6kV line-line, 10kV line-earth	DM 6kV, CM 10kV
		Features	Waterproof (IP67)	IP67
		Safety & EMC Compliance	EN 55015 ⁽¹⁾	EN 55015/KN 15 ⁽¹⁾
		Safety & EMC Compliance	EN 61000-4-5	Updated
		Mechanical Outline	/	Updated
		RoHS Compliance	/	Updated