

| 修 订 | 标 记 | 修 改 描 述 | 签 名 | 日 期 |
|-----|------|----------------------|-----------|------------|
| REV | MARK | REVISION DESCRIPTION | SIGNATURE | DATE |
| AO | | NEW DWG | | 2016-03-12 |

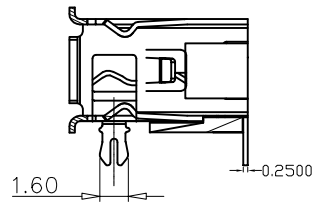

SECTION A-A

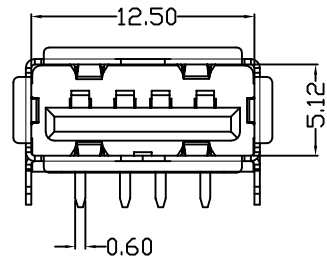
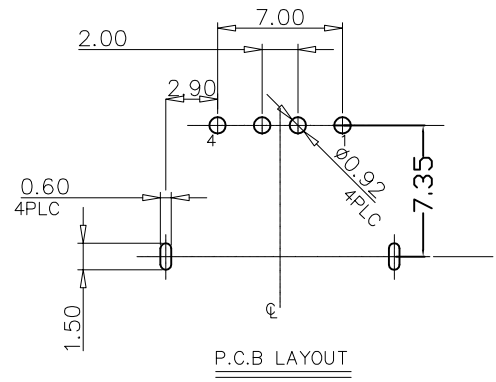
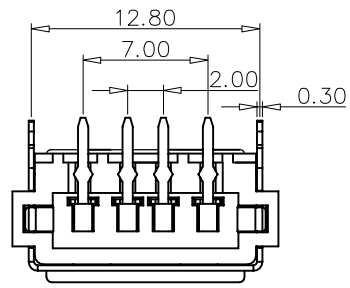
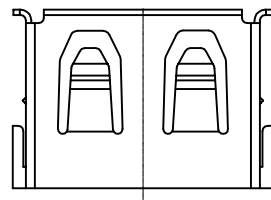
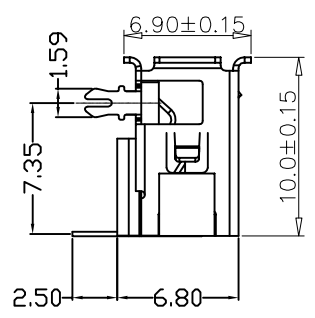
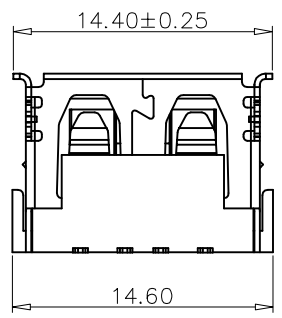

P.C.B LAYOUT

规格说明:Specifications:

电气特性:Electrical:

1. 额定电流: Current Rating
1.5A/contact terminal
2. 额定电压: Voltage Rating
30V DC
3. 接触阻抗: Contact Resistance
30 milliohms MAX
4. 耐电压: Dielectric Withstanding Voltage:
500 V AC AT Sea Level
5. 绝缘阻抗: Insulation Resistance:
1000MEGA ohms MIN

物理性能: Mechanical:



1. 插拔力: Connector Mate and Unmate Force
Mate force: 3.57kgf (MAX)
Unmate force: 1.02kgf (MIN)
2. 端子保持力: Terminal Retention
1.2kgf (MIN)

原材料: Material:

1. 塑胶: Housing:
Hing Temperature Thermoplastics,
Ul 94V-0 PBT White/Black
2. 端子: Contact: Copper Alloy C2680
3. 外壳: Shell: SPCC

电镀: Finish:

1. 端子: Contact: Plated Gold in Mating Area;
Tin On Solder Talls
2. 外壳: Shell:
Nickel Plating

| | | | | | | | | |
|---|-------|---|-----|---|----------------------------------|-------|------|-------------|
|  | | 深圳市华德共创科技有限公司 Shenzhen Huade co-create Technology Co.,LTD 电话: 0755-23304126 传真: 0755-29940187 | | | | | | |
| -TOLERANCES- UNLESS OTHERWISE SPECIFIED 公差参数表 | |   | | TITLE: 产品名称: USB AF10.0前插后插卷边6.8白胶反向 | | | | |
| X.X | ±0.30 | X.X* | ±3° | APPD: 核准: | PART NO: 产品编号: USB-HXS-117DIP | | | |
| X.XX | ±0.20 | X.XX* | ±2° | CHECK: 校对: 王建业 | DATE | SCALE | UNIT | CODE NUMBER |
| X.XXX | ±0.10 | X.XXX* | ±1° | DRAW: 绘图: 黄艳兰 | 2016-03-12 | 1:1 | mm | A001 |

由 Autodesk 教育版产品制作

由 Autodesk 教育版产品制作