

## Feed-through header - MSTB 2,5/ 4-G-5,08 - 1759033

Please be informed that the data shown in this PDF Document is generated from our Online Catalog. Please find the complete data in the user's documentation. Our General Terms of Use for Downloads are valid (<http://phoenixcontact.com/download>)

PCB headers, nominal current: 12 A, number of positions: 4, pitch: 5.08 mm, color: green, contact surface: Tin, mounting: Wave soldering



The figure shows a 10-position version of the product

### Your advantages

- ✓ Maximum flexibility when it comes to device design – one header for connectors with different connection technologies
- ✓ Easy PCB replacement thanks to plug-in modules
- ✓ Well-known mounting principle allows worldwide use
- ✓ Plug-in direction parallel to the PCB
- ✓ Items that can be aligned in various pitches support flexible and space-saving PCB assembly



### Key Commercial Data

Packing unit	1 pc
GTIN	
GTIN	4017918030506
Weight per Piece (excluding packing)	1.880 g
Custom tariff number	85366930
Country of origin	Germany

### Technical data

#### Dimensions

Length [ l ]	12 mm
Width	20.32 mm
Pitch	5.08 mm
Dimension a	15.24 mm

## Feed-through header - MSTB 2,5/ 4-G-5,08 - 1759033

### Technical data

#### Dimensions

Width [ w ]	20.32 mm
Height [ h ]	12.1 mm
Height	8.6 mm
Length of the solder pin	3.5 mm
Pin dimensions	1 x 1 mm
Length	12 mm

#### General

Range of articles	MSTB 2,5/..-G
Insulating material group	I
Rated surge voltage (III/3)	4 kV
Rated surge voltage (III/2)	4 kV
Rated surge voltage (II/2)	4 kV
Rated voltage (III/3)	250 V
Rated voltage (III/2)	320 V
Rated voltage (II/2)	400 V
Connection in acc. with standard	EN-VDE
Nominal current $I_N$	12 A
Maximum load current	12 A
Insulating material	PA
Flammability rating according to UL 94	V0
Color	green
Number of positions	4

#### Standards and Regulations

Connection in acc. with standard	EN-VDE
	CSA
Flammability rating according to UL 94	V0

#### Environmental Product Compliance

China RoHS	Environmentally friendly use period: unlimited = EFUP-e
	No hazardous substances above threshold values

### Drawings

# Feed-through header - MSTB 2,5/ 4-G-5,08 - 1759033

Diagram

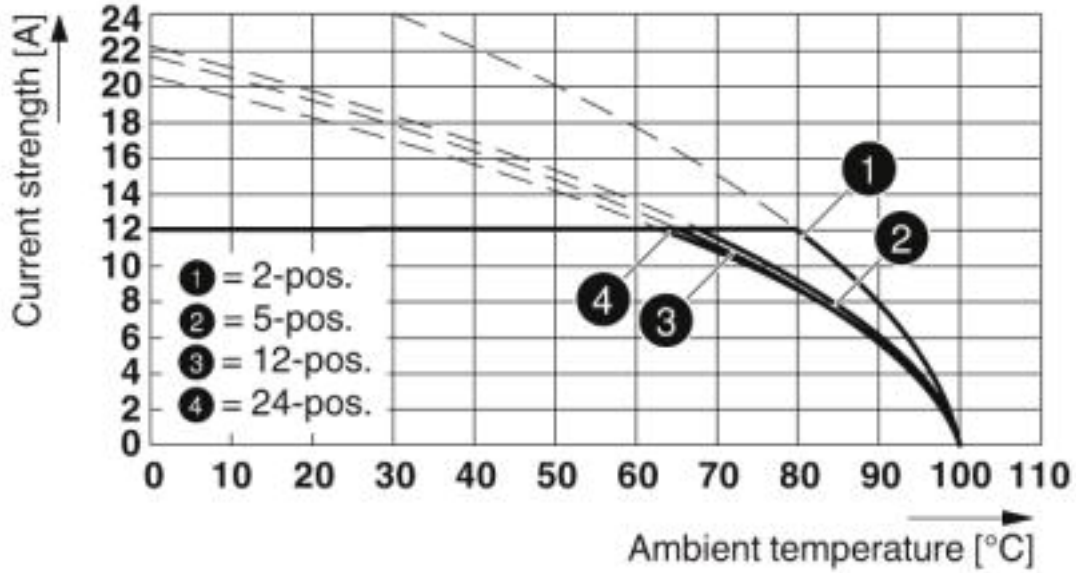

Type: MSTB 2,5/...-ST-5,08 with MSTB 2,5/...-G-5,08

Diagram

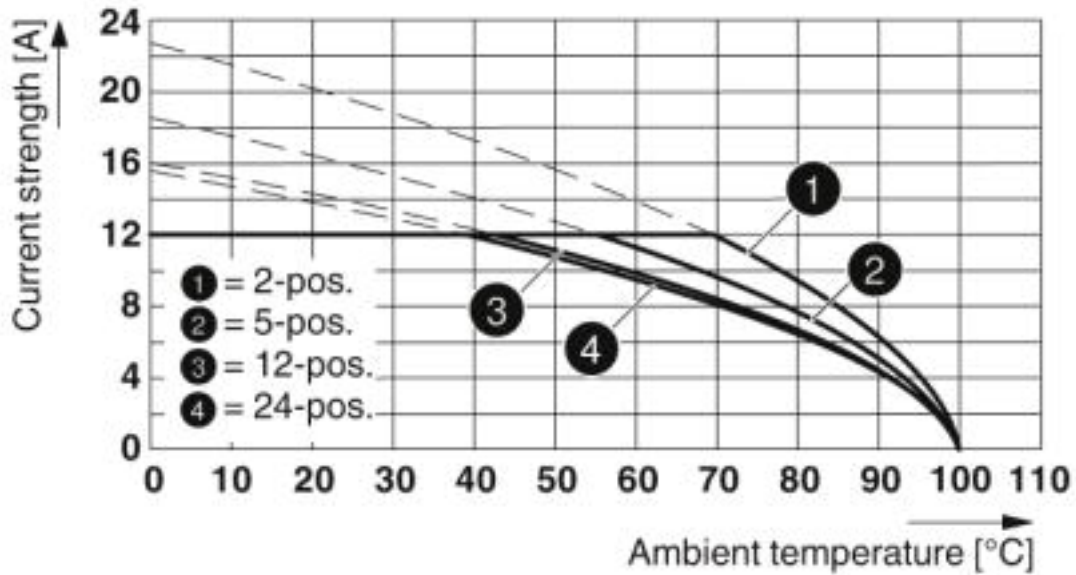

Type: MSTBU 2,5/...-STD-5,08 with MSTB 2,5/...-G-5,08

# Feed-through header - MSTB 2,5/ 4-G-5,08 - 1759033

Diagram

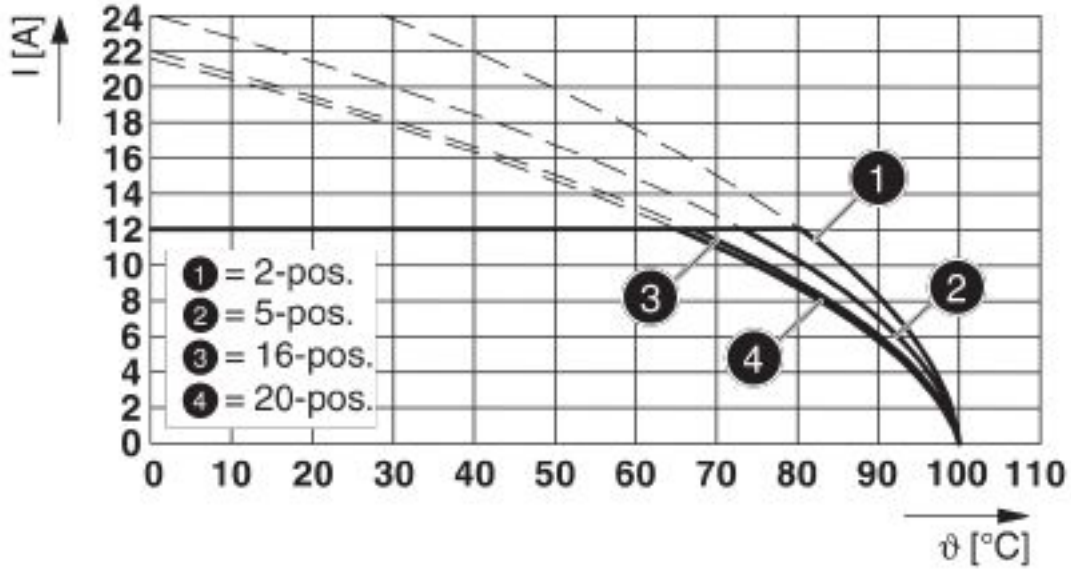

Type: FKCT 2,5/...-ST-5,08 with MSTB 2,5/...-G-5,08

Diagram

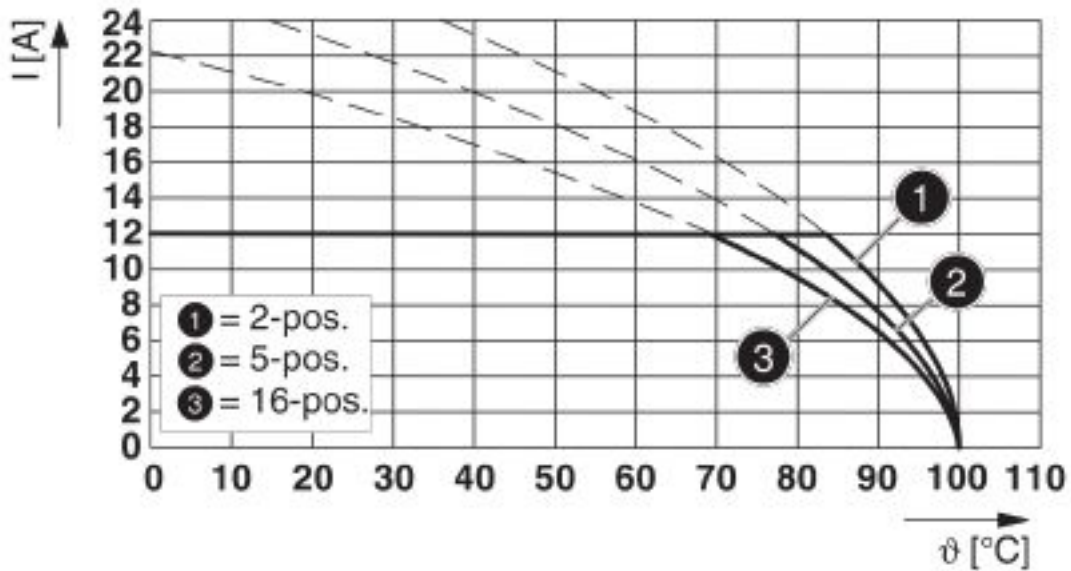

Type: FKCV(W/R) 2,5/...-ST-5,08 with MSTB 2,5/...-G-5,08

# Feed-through header - MSTB 2,5/ 4-G-5,08 - 1759033

Diagram

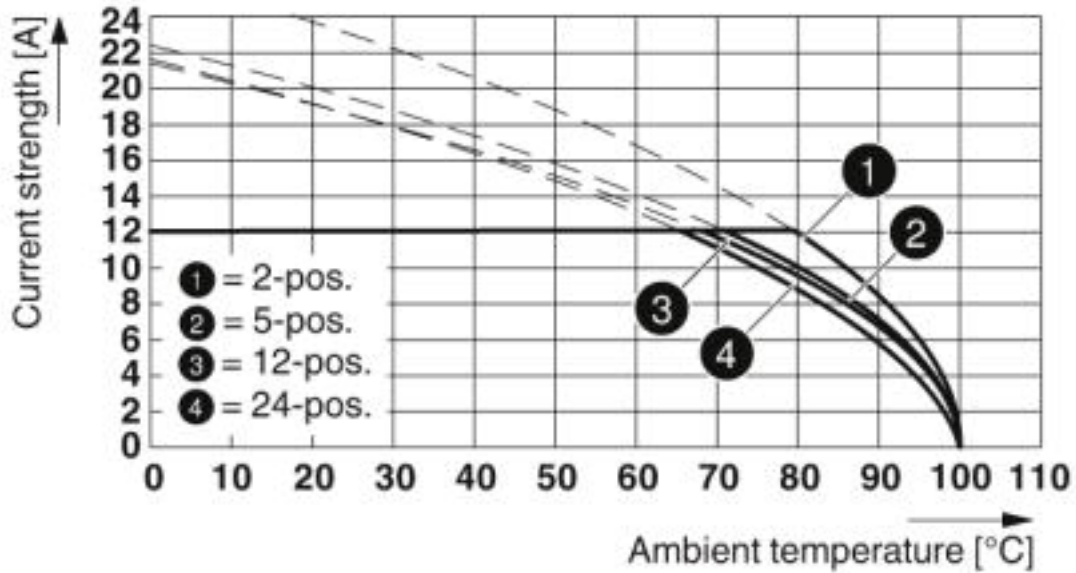

Type: MSTBP 2,5/...-ST-5,08 with MSTB 2,5/...-G-5,08

Diagram

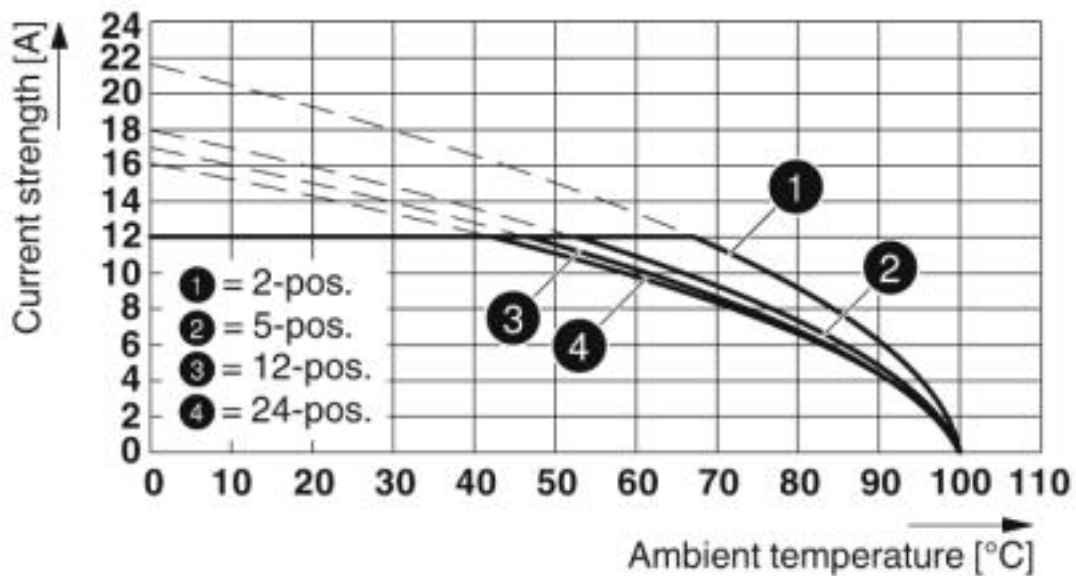

Type: SMSTB 2,5/...-ST-5,08 with MSTB 2,5/...-G-5,08

# Feed-through header - MSTB 2,5/ 4-G-5,08 - 1759033

Diagram

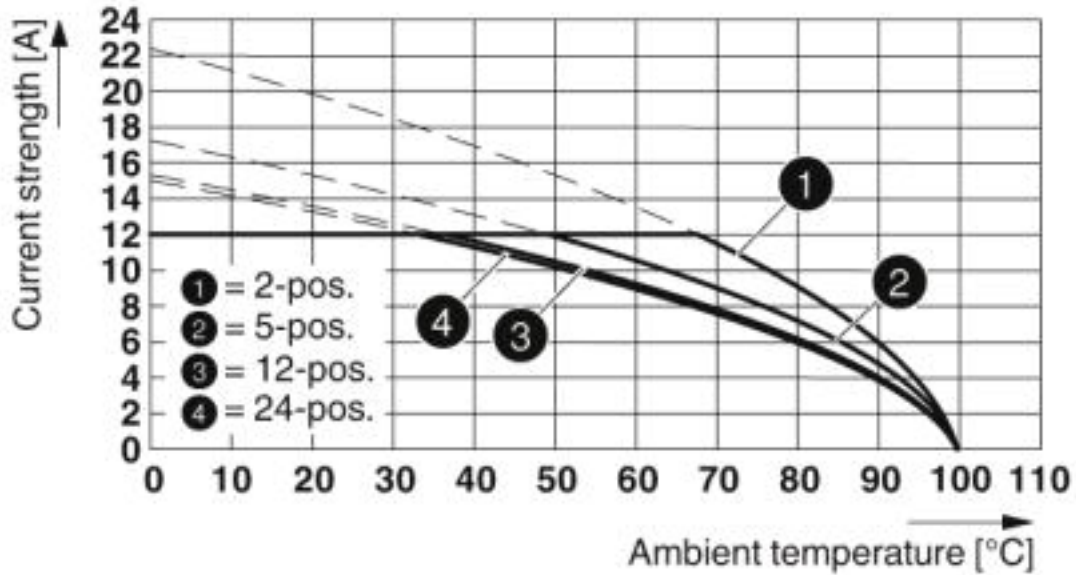

Type: MVSTB(R/W) 2,5/...-ST with MDSTBVA 2,5/...-G-5,08

Diagram

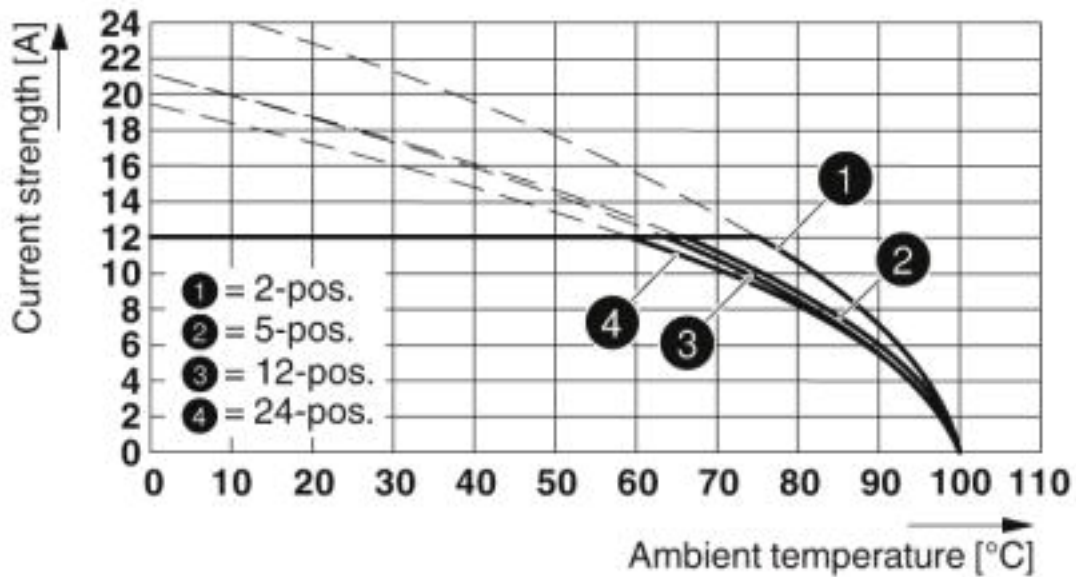

Type: FRONT-MSTB 2,5/...-ST-5,08 with MSTB 2,5/...-G-5,08

# Feed-through header - MSTB 2,5/ 4-G-5,08 - 1759033

Diagram

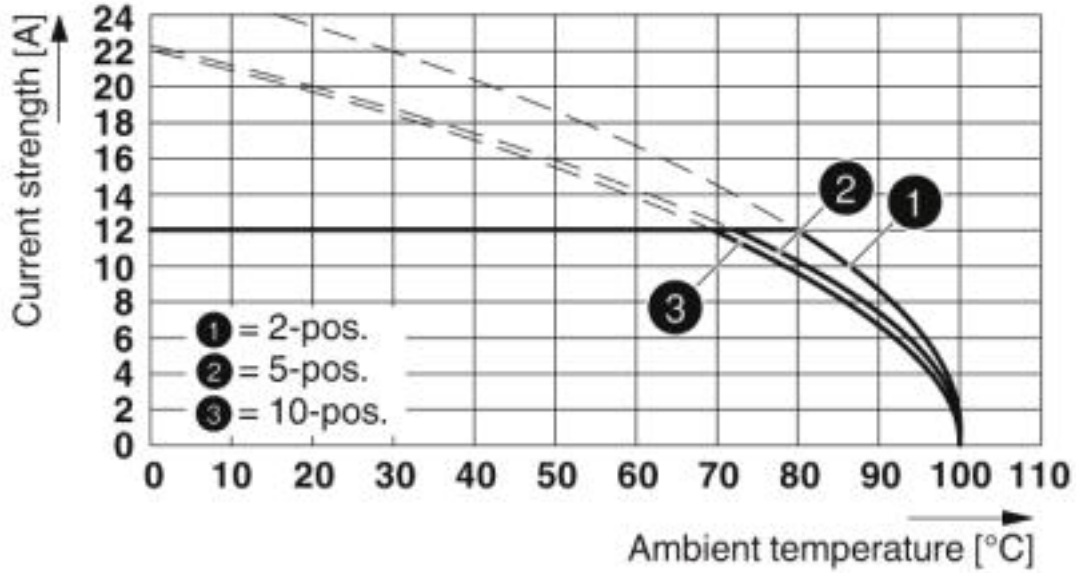

Type: TMSTBP 2,5/...-ST-5,08 with MSTB 2,5/...-G-5,08

Diagram

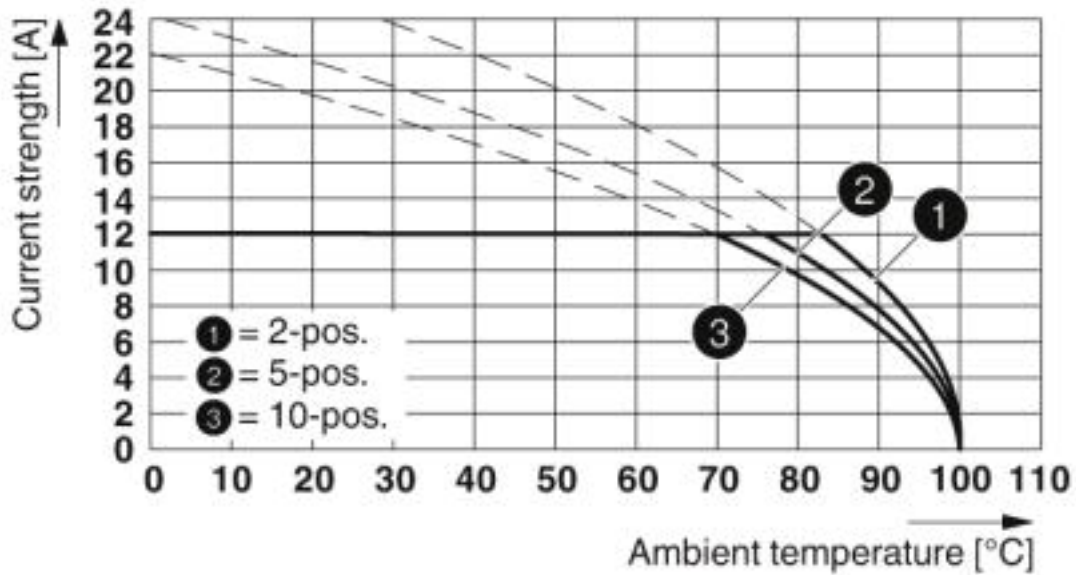

Type: TVMSTB 2,5/...-ST-5,08 with MSTB 2,5/...-G-5,08



# Feed-through header - MSTB 2,5/ 4-G-5,08 - 1759033

Diagram

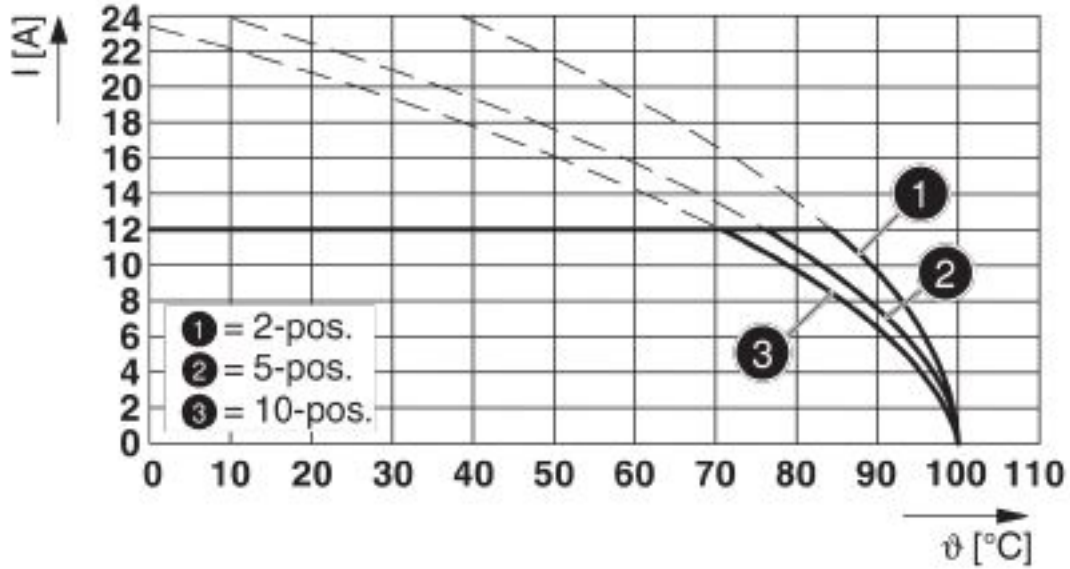

Type: TFKC 2,5/...-ST-5,08 with MSTB 2,5/...-G-5,08

Dimensional drawing

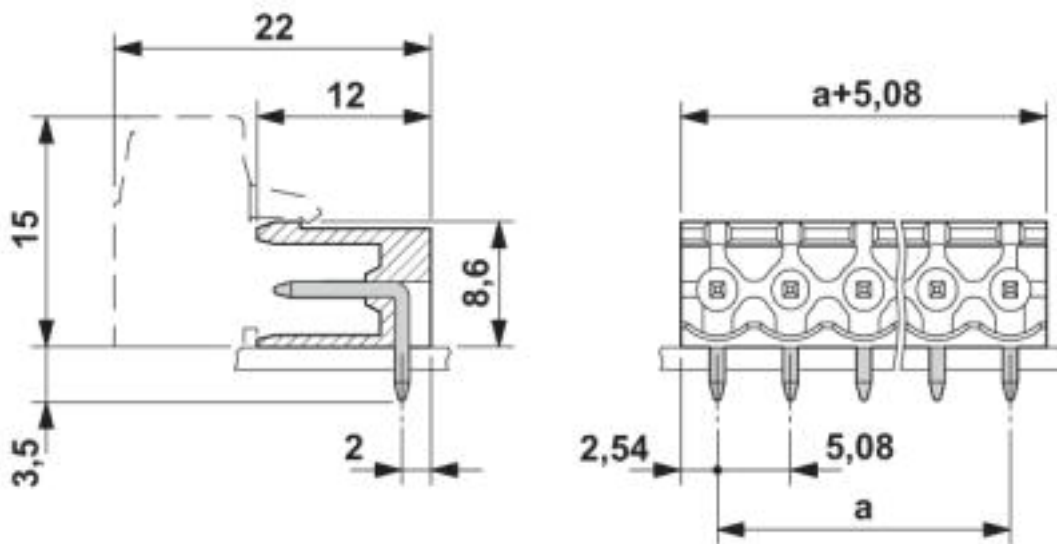

## Classifications

eCl@ss

eCl@ss 4.0	27260700
------------	----------



## Feed-through header - MSTB 2,5/ 4-G-5,08 - 1759033

### Classifications

#### eCl@ss

eCl@ss 4.1	27260700
eCl@ss 5.0	27260700
eCl@ss 5.1	27260700
eCl@ss 6.0	27260700
eCl@ss 7.0	27440402
eCl@ss 8.0	27440402
eCl@ss 9.0	27440402

#### ETIM

ETIM 3.0	EC001121
ETIM 4.0	EC002637
ETIM 5.0	EC002637
ETIM 6.0	EC002637
ETIM 7.0	EC002637

#### UNSPSC

UNSPSC 6.01	30211810
UNSPSC 7.0901	39121409
UNSPSC 11	39121409
UNSPSC 12.01	39121409
UNSPSC 13.2	39121409

### Approvals

#### Approvals

---

#### Approvals

CSA / IECCEB CB Scheme / VDE Gutachten mit Fertigungsüberwachung / EAC / cULus Recognized

---

#### Ex Approvals

---

#### Approval details

# Feed-through header - MSTB 2,5/ 4-G-5,08 - 1759033

## Approvals

CSA		<a href="http://www.csagroup.org/services-industries/product-listing/">http://www.csagroup.org/services-industries/product-listing/</a>	13631
	B	D	
Nominal voltage UN	300 V	300 V	
Nominal current IN	10 A	10 A	

IECEE CB Scheme		<a href="http://www.iecee.org/">http://www.iecee.org/</a>	DE1-60988-B1B2
Nominal voltage UN	250 V		
Nominal current IN	12 A		

VDE Gutachten mit Fertigungsüberwachung		<a href="http://www2.vde.com/de/Institut/Online-Service/VDE-gepruefteProdukte/Seiten/Online-Suche.aspx">http://www2.vde.com/de/Institut/Online-Service/VDE-gepruefteProdukte/Seiten/Online-Suche.aspx</a>	40004701
Nominal voltage UN	250 V		
Nominal current IN	12 A		

EAC			B.01742
-----	---	--	---------

cULus Recognized		<a href="http://database.ul.com/cgi-bin/XYV/template/LISEXT/1FRAME/index.htm">http://database.ul.com/cgi-bin/XYV/template/LISEXT/1FRAME/index.htm</a>	E60425-19931011
	B	D	
Nominal voltage UN	300 V	150 V	
Nominal current IN	15 A	15 A	

## Accessories

Accessories

Coding element

## Feed-through header - MSTB 2,5/ 4-G-5,08 - 1759033

### Accessories

Coding section - CR-MSTB - 1734401



Coding section, inserted into the recess in the header or the inverted plug, red insulating material

---

### Filler plug

Accessories - MSTB-BL - 1755477



Keying cap, for forming sections, plugs onto header pin, green insulating material

---

### Flange

Accessories - MSTB-BF - 1759981



Mounting flange, for fixing both ends of the header onto the PCB, green insulating material, with M 2 x 14 screws and nuts.

---

### Labeled terminal marker

Marker card - SK 5,08/3,8:FORTL.ZAHLEN - 0804293



Marker card, Card, white, labeled, Horizontal: consecutive numbers 1 ... 10, 11 ... 20, etc. up to 91 ... (99)100, mounting type: adhesive, for terminal block width: 5.08 mm, lettering field size: 5.08 x 3.8 mm

---

### Marker pen

## Feed-through header - MSTB 2,5/ 4-G-5,08 - 1759033

### Accessories

Marker pen - B-STIFT - 1051993



Marker pen, for manual labeling of unprinted Zack strips, smear-proof and waterproof, line thickness 0.5 mm

---

### Terminal marking

Marker card - SK 5,08/3,8:UNBEDRUCKT - 0805412



Marker card, Card, white, unlabeled, can be labeled with: Marker pen, mounting type: adhesive, for terminal block width: 5.08 mm, lettering field size: 5.08 x 3.8 mm

---

### Additional products

Printed-circuit board connector - TVMSTB 2,5/ 4-ST-5,08 - 1719024



PCB connector, nominal current: 12 A, number of positions: 4, pitch: 5.08 mm, connection method: Screw connection with tension sleeve, color: green, contact surface: Tin

---

Printed-circuit board connector - FKCN 2,5/ 4-ST-5,08 - 1754584



PCB connector, nominal current: 12 A, number of positions: 4, pitch: 5.08 mm, connection method: Push-in spring connection, color: green, contact surface: Tin

---

Printed-circuit board connector - MSTB 2,5/ 4-ST-5,08 - 1757035



PCB connector, nominal current: 12 A, number of positions: 4, pitch: 5.08 mm, connection method: Screw connection with tension sleeve, color: green, contact surface: Tin

## Feed-through header - MSTB 2,5/ 4-G-5,08 - 1759033

### Accessories

---

#### Printed-circuit board connector - MSTBP 2,5/ 4-ST-5,08 - 1769036



PCB connector, nominal current: 12 A, number of positions: 4, pitch: 5.08 mm, connection method: Screw connection with tension sleeve, color: green, contact surface: Tin

#### Printed-circuit board connector - MSTB 2,5/ 4-STZ-5,08 - 1776155



PCB connector, nominal current: 12 A, number of positions: 4, pitch: 5.08 mm, connection method: Screw connection with tension sleeve, color: green, contact surface: Tin

#### Printed-circuit board connector - FRONT-MSTB 2,5/ 4-ST-5,08 - 1777303



PCB connector, nominal current: 12 A, number of positions: 4, pitch: 5.08 mm, connection method: Front screw connection, color: green, contact surface: Tin

#### Printed-circuit board connector - MSTBT 2,5/ 4-ST-5,08 - 1780002



PCB connector, nominal current: 12 A, number of positions: 4, pitch: 5.08 mm, connection method: Screw connection with tension sleeve, color: green, contact surface: Tin

#### Printed-circuit board connector - MVSTBR 2,5/ 4-ST-5,08 - 1792265



PCB connector, nominal current: 12 A, number of positions: 4, pitch: 5.08 mm, connection method: Screw connection with tension sleeve, color: green, contact surface: Tin

## Feed-through header - MSTB 2,5/ 4-G-5,08 - 1759033

### Accessories

#### Printed-circuit board connector - MVSTBW 2,5/ 4-ST-5,08 - 1792773



PCB connector, nominal current: 12 A, number of positions: 4, pitch: 5.08 mm, connection method: Screw connection with tension sleeve, color: green, contact surface: Tin

#### Printed-circuit board connector - MSTBC 2,5/ 4-ST-5,08 - 1808832



PCB connector, nominal current: 12 A, number of positions: 4, pitch: 5.08 mm, connection method: Crimp connection, color: green, Corresponding female crimp contacts with current [A] and conductor cross section range [mm<sup>2</sup>] data: 10A/MSTBC-MT 0,5-1,0 (3190564); 10A/MSTBC-MT 0,5-1,0 BA (3190645); 12A/MSTBC-MT 1,5-2,5 (3190551); 12A/MSTBC-MT 1,5-2,5 BA (3190658). BA = Bandkontakte

#### Printed-circuit board connector - MSTBC 2,5/ 4-STZ-5,08 - 1809527



PCB connector, nominal current: 12 A, number of positions: 4, pitch: 5.08 mm, connection method: Crimp connection, color: green, Corresponding female crimp contacts with current [A] and conductor cross section range [mm<sup>2</sup>] data: 10A/MSTBC-MT 0,5-1,0 (3190564); 10A/MSTBC-MT 0,5-1,0 BA (3190645); 12A/MSTBC-MT 1,5-2,5 (3190551); 12A/MSTBC-MT 1,5-2,5 BA (3190658). BA = Bandkontakte

#### Printed-circuit board connector - MSTBU 2,5/ 4-STD-5,08 - 1824146



Direct plug-in block, nominal current: 12 A, number of positions: 4, pitch: 5.08 mm, connection method: Screw connection with tension sleeve, color: green, contact surface: Tin, mounting: Direct mounting

#### Printed-circuit board connector - MSTBU 2,5/ 4-ST-5,08-FL - 1824379



Direct plug-in block, nominal current: 12 A, number of positions: 4, pitch: 5.08 mm, connection method: Screw connection with tension sleeve, color: green, contact surface: Tin, mounting: Direct mounting

## Feed-through header - MSTB 2,5/ 4-G-5,08 - 1759033

### Accessories

Printed-circuit board connector - SMSTB 2,5/ 4-ST-5,08 - 1826306

PCB connector, nominal current: 12 A, number of positions: 4, pitch: 5.08 mm, connection method: Screw connection with tension sleeve, color: green, contact surface: Tin



Printed-circuit board connector - TMSTBP 2,5/ 4-ST-5,08 - 1853036

PCB connector, nominal current: 12 A, number of positions: 4, pitch: 5.08 mm, connection method: Screw connection with tension sleeve, color: green, contact surface: Tin, The plug allows conductors to be looped through from module to module.



Printed-circuit board connector - FKC 2,5/ 4-ST-5,08 - 1873074

PCB connector, nominal current: 12 A, number of positions: 4, pitch: 5.08 mm, connection method: Push-in spring connection, color: green, contact surface: Tin



Printed-circuit board connector - FKCVW 2,5/ 4-ST-5,08 - 1873676

PCB connector, nominal current: 12 A, number of positions: 4, pitch: 5.08 mm, connection method: Push-in spring connection, color: green, contact surface: Tin



Printed-circuit board connector - FKCVR 2,5/ 4-ST-5,08 - 1873977

PCB connector, nominal current: 12 A, number of positions: 4, pitch: 5.08 mm, connection method: Push-in spring connection, color: green, contact surface: Tin





## Feed-through header - MSTB 2,5/ 4-G-5,08 - 1759033

### Accessories

Printed-circuit board connector - QC 1/ 4-ST-5,08 - 1883271

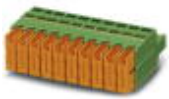

PCB connector, nominal current: 10 A, number of positions: 4, pitch: 5.08 mm, connection method: Displacement connection, color: green, contact surface: Tin

Printed-circuit board connector - FKCT 2,5/ 4-ST-5,08 - 1902136



PCB connector, nominal current: 12 A, number of positions: 4, pitch: 5.08 mm, connection method: Push-in spring connection, color: green, contact surface: Tin

Printed-circuit board connector - TFKC 2,5/ 4-ST-5,08 - 1962626



PCB connector, nominal current: 12 A, number of positions: 4, pitch: 5.08 mm, connection method: Push-in spring connection, color: green, contact surface: Tin

Printed-circuit board connector - FKCS 2,5/ 4-ST-5,08 - 1975095



PCB connector, nominal current: 12 A, number of positions: 4, pitch: 5.08 mm, connection method: Push-in spring connection, color: green, contact surface: Tin