

Varistors (ZNR Surge Absorber) CK type (UL and CSA Recognized)

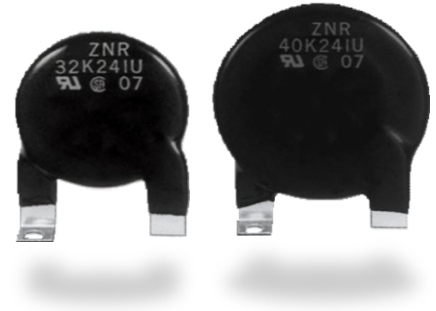

Varistors (ZNR Surge Absorber) with Tabs is a heavy duty type ZNR with very unique tab terminals which bring forth a higher reliability. These tabs are used as electrical connecting terminals and also its mounting legs. This type of ZNR is meant for applications in power supplies or ransient voltage surge suppressor units where large surge current or high surge energy absorption is required.

Features

- UL and CSA recognized components
- High energy handling capability (210 to 750 joules)
- Large withstanding peak current (20 to 25 kA, 8/20 μs, 2 times)
- Common terminals for electrical connection and mounting
- RoHS compliant

Recommended applications

- Power suppliers for OA, FA, telecommunication or industrial equipment
- Power strips
- Transient voltage surge suppressor units

Related standards

Standard No.	UL1449	CSA C22.2 No.269.5
Title	Surge protective devices	Surge protective devices - Type 5 – Components

- Each type designation is not registered by Part Number.
Please contact us for further questions regarding type designation.

Note : Ask our factory for Product Specification before use.

■ As for handling precautions and minimum quantity / Packing unit please see related information.

Explanation of part numbers

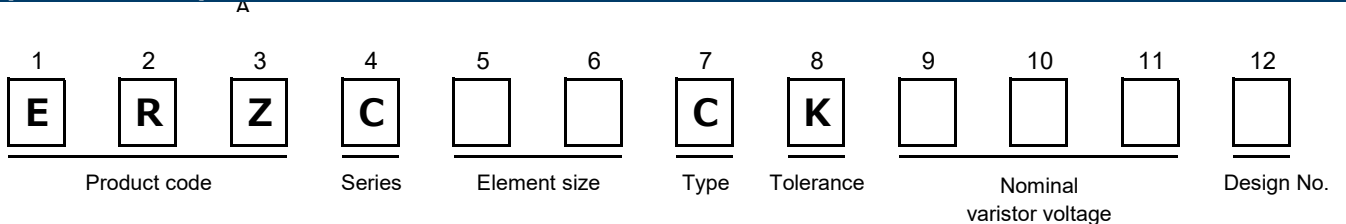

Ratings and characteristics

●Operating temperature range : -40 to 85 °C

●Operating temperature range : -40 to 125 °C

Part No. (UL/CSA Recognized)	Type designation	Varistor voltage at 1m A (V)	Maximum allowable voltage		Maximum clamping voltage		Maximum energy (2ms)		Maximum peak current (8/20 μs)	
			AC rms(V)	DC (V)	VXA (V)	I _p (A)	1 time (J)	1 time (kA)	2 times (kA)	
ERZC32CK201W	32K201U	200 (185 to 225)	130	170	340	200	210	25	20	
ERZC32CK241W	32K241U	240 (216 to 264)	150	200	395	200	240	25	20	
ERZC32CK271W	32K271U	270 (247 to 303)	175	225	455	200	255	25	20	
ERZC32CK361W	32K361U	360 (324 to 396)	230	300	595	200	325	25	20	
ERZC32CK391W	32K391U	390 (351 to 429)	250	320	650	200	350	25	20	
ERZC32CK431W	32K431U	430 (387 to 473)	275	350	710	200	400	25	20	
ERZC32CK471W	32K471U	470 (423 to 517)	300	385	775	200	405	25	20	
ERZC32CK511W	32K511U	510 (459 to 561)	320	415	845	200	405	25	20	
ERZC32CK621W	32K621U	620 (558 to 682)	385	505	1025	200	415	25	20	
ERZC32CK681W	32K681U	680 (612 to 748)	420	560	1120	200	450	25	20	
ERZC32CK751W	32K751U	750 (675 to 825)	460	615	1240	200	500	25	20	
ERZC32CK781W	32K781U	780 (702 to 858)	485	640	1290	200	520	25	20	
ERZC32CK821W	32K821U	820 (738 to 902)	510	670	1355	200	545	25	20	
ERZC32CK911W	32K911U	910 (819 to 1001)	550	745	1500	200	600	25	20	
ERZC32CK951W	32K951U	950 (855 to 1045)	575	765	1570	200	600	25	20	
ERZC40CK201W	40K201U	200 (185 to 225)	130	170	340	250	260	30	25	
ERZC40CK241W	40K241U	240 (216 to 264)	150	200	395	250	300	30	25	
ERZC40CK271W	40K271U	270 (247 to 303)	175	225	455	250	340	30	25	
ERZC40CK361W	40K361U	360 (324 to 396)	230	300	595	250	405	30	25	
ERZC40CK391W	40K391U	390 (351 to 429)	250	320	650	250	435	30	25	
ERZC40CK431W	40K431U	430 (387 to 473)	275	350	710	250	500	30	25	
ERZC40CK471W	40K471U	470 (423 to 517)	300	385	775	250	505	30	25	
ERZC40CK511W	40K511U	510 (459 to 561)	320	415	845	250	505	30	25	
ERZC40CK621W	40K621U	620 (558 to 682)	385	505	1025	250	515	30	25	
ERZC40CK681W	40K681U	680 (612 to 748)	420	560	1120	250	560	30	25	
ERZC40CK751W	40K751U	750 (675 to 825)	460	615	1240	250	625	30	25	
ERZC40CK781W	40K781U	780 (702 to 858)	485	640	1290	250	650	30	25	
ERZC40CK821W	40K821U	820 (738 to 902)	510	670	1355	250	680	30	25	
ERZC40CK911W	40K911U	910 (819 to 1001)	550	745	1500	250	750	30	25	
ERZC40CK951W	40K951U	950 (855 to 1045)	575	765	1570	250	750	30	25	

Dimensions (not to scale)

Unit : mm

- ZNR
- Abbreviation of Part No.
- Date code

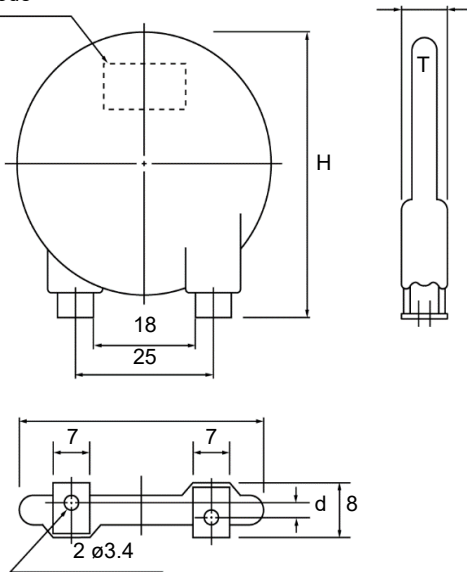

Part No. (UL/CSA recognized)	Type designation	D max.	H max.	T max.	d
ERZC32CK201W	32K201U	36	46	7.5	5.7±1.0
ERZC32CK241W	32K241U			7.5	5.4±1.0
ERZC32CK271W	32K271U			8.5	5.2±1.0
ERZC32CK361W	32K361U			9.0	4.6±1.0
ERZC32CK391W	32K391U			9.0	4.4±1.0
ERZC32CK431W	32K431U			9.0	4.1±1.0
ERZC32CK471W	32K471U			9.7	3.9±1.0
ERZC32CK511W	32K511U			9.7	4.5±1.0
ERZC32CK621W	32K621U			9.7	3.9±1.0
ERZC32CK681W	32K681U			9.7	3.6±1.0
ERZC32CK751W	32K751U			10.5	3.3±1.0
ERZC32CK781W	32K781U			10.5	3.1±1.0
ERZC32CK821W	32K821U			10.5	2.9±1.0
ERZC32CK911W	32K911U			11.5	2.5±1.0
ERZC32CK951W	32K951U			11.5	2.3±1.0
ERZC40CK201W	40K201U			44	50
ERZC40CK241W	40K241U	7.5	5.4±1.0		
ERZC40CK271W	40K271U	8.5	5.2±1.0		
ERZC40CK361W	40K361U	9.0	4.6±1.0		
ERZC40CK391W	40K391U	9.0	4.4±1.0		
ERZC40CK431W	40K431U	9.0	4.1±1.0		
ERZC40CK471W	40K471U	9.7	3.9±1.0		
ERZC40CK511W	40K511U	9.7	4.5±1.0		
ERZC40CK621W	40K621U	9.7	3.9±1.0		
ERZC40CK681W	40K681U	9.7	3.6±1.0		
ERZC40CK751W	40K751U	10.5	3.3±1.0		
ERZC40CK781W	40K781U	10.5	3.1±1.0		
ERZC40CK821W	40K821U	10.5	2.9±1.0		
ERZC40CK911W	40K911U	11.5	2.5±1.0		
ERZC40CK951W	40K951U	11.5	2.3±1.0		

Typical characteristics

Voltage vs. Current

(ERZC32CK201W to ERZC32CK951W)

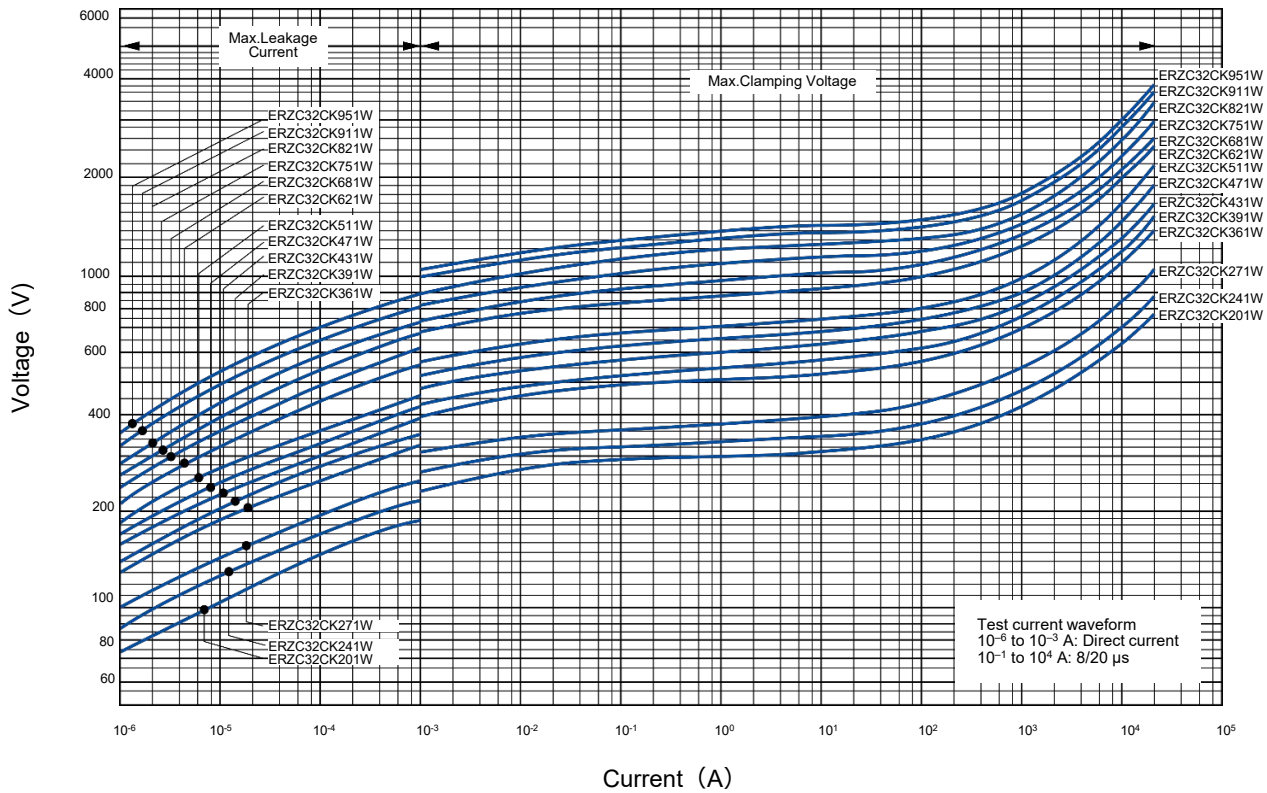

(ERZC40CK201W to ERZC40CK951W)

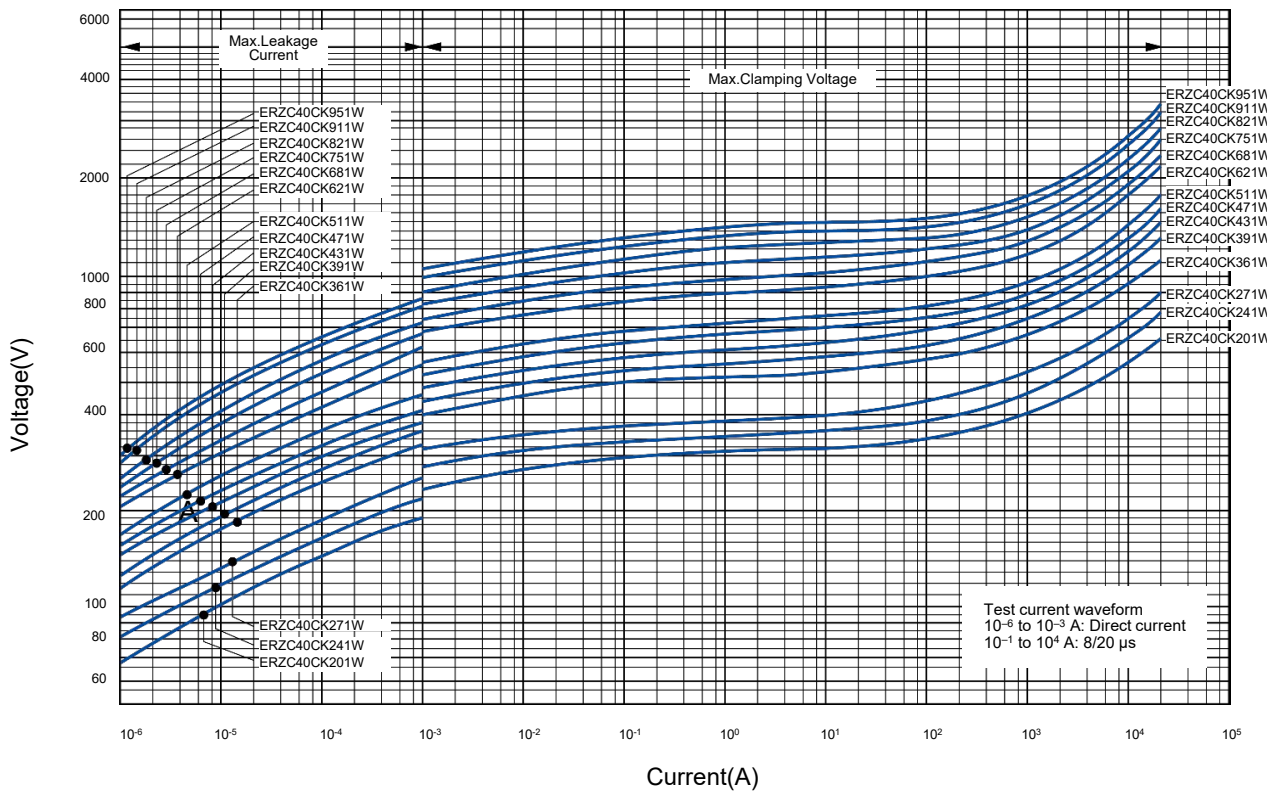

Application note for safety standards

- Approvals products lists in "Reference Guide to Standard Products."
- UL and VDE : Registered in "Type name", it isn't registered in "Panasonic Part No."
- CQC : Registered in "Panasonic Part No."
- "Rated Voltages" are specified for UL recognized components in list shown below.

The AC rated voltage and maximum allowable voltage

Part No. (UL/CSA recognized)	Maximum allowable voltage		Rated voltage (Vrms)	
	AC rms (V)	DC (V)	UL1449	CSA C22.2 No.269.5
ERZC32CK201W	130	170	118	118
ERZC32CK241W	150	200	136	136
ERZC32CK271W	175	225	159	159
ERZC32CK361W	230	300	209	209
ERZC32CK391W	250	320	227	227
ERZC32CK431W	275	350	250	250
ERZC32CK471W	300	385	272	272
ERZC32CK511W	320	415	291	291
ERZC32CK621W	385	505	350	350
ERZC32CK681W	420	560	381	381
ERZC32CK751W	460	615	418	418
ERZC32CK781W	485	640	440	440
ERZC32CK821W	510	670	463	463
ERZC32CK911W	550	745	500	500
ERZC32CK951W	575	765	522	522
ERZC40CK201W	130	170	118	118
ERZC40CK241W	150	200	136	136
ERZC40CK271W	175	225	159	159
ERZC40CK361W	230	300	209	209
ERZC40CK391W	250	320	227	227
ERZC40CK431W	275	350	250	250
ERZC40CK471W	300	385	272	272
ERZC40CK511W	320	415	291	291
ERZC40CK621W	385	505	350	350
ERZC40CK681W	420	560	381	381
ERZC40CK751W	460	615	418	418
ERZC40CK781W	485	640	440	440
ERZC40CK821W	510	670	463	463
ERZC40CK911W	550	745	500	500
ERZC40CK951W	575	765	522	522

Performance characteristics

Characteristics		Test methods/description	Specifications																
Standard test condition		Electrical measurements (initial/after tests) shall be conducted at temperature of 5 to 35 °C, relative humidity of maximum 85 %.	—																
Electrical	Varistor voltage	The voltage between two terminals with the specified measuring current 1mA DC applied is called V_1 or V_{1mA} . The measurement shall be made as fast as possible to avoid heat affection.	To meet the specified value																
	Maximum allowable voltage	The maximum sinusoidal wave voltage (rms) or the maximum DC voltage that can be applied continuously.																	
	Clamping voltage	The maximum voltage between two terminals with the specified standard impulse current (8/20 μ s).																	
	Rated power	The maximum power that can be applied within the specified ambient temperature.																	
	Maximum energy	The maximum energy within the varistor voltage change of ± 10 % when one impulse of 2 ms is applied.																	
	Maximum peak current	2 times		The maximum current within the varistor voltage change of ± 10 % with the standard impulse current (8/20 μ s) applied two times with an interval of 5 minutes.															
1 time		The maximum current within the varistor voltage change of ± 10 % with the standard impulse current (8/20 μ s) applied one time.																	
Mechanical	Robustness of terminations (Tensile)	After gradually applying the load of 19.6 N (2 kgf) and keeping the unit fixed for 10 seconds, the terminal shall be visually examined for any damage.	No remarkable damage																
	Vibration	After repeatedly applying a single harmonic vibration (amplitude: 0.35 mm): double amplitude: 0.7 mm with 1 minute vibration frequency cycles (10 Hz to 55 Hz to 10 Hz) to each of three perpendicular directions for 2 hours. Thereafter, the unit shall be visually examined.	No remarkable damage																
	Solderability	After dipping the terminal to a depth of approximately 3 mm from the body in a soldering bath of 230 \pm 5 °C for 5.0 \pm 0.5 seconds, the terminal shall be visually examined.	Approximately 95 % of the terminals shall be covered with new solder uniformly.																
	Resistance to soldering heat	The terminal shall be dipped into a soldering bath having a temperature of 350 \pm 10 °C to a point 4.0 \pm 0.8 mm from the body of the unit and then be held there for 3.0 \pm 0.5 seconds. The change of V_c and mechanical damage shall be examined.	$\Delta V_{1mA}/V_{1mA} \leq \pm 5 \%$																
Environmental	Dry heat/ high temperature storage	The specimen shall be subjected to 125 \pm 2 °C for 500 hours in a thermostatic bath without load and then stored at room temperature and humidity for one to two hours. Thereafter, the change of V_c shall be measured.	$\Delta V_{1mA}/V_{1mA} \leq \pm 5 \%$																
	Damp heat/humidity (Steady State)	The specimen shall be subjected to 40 \pm 2 °C, 90 to 95 %RH for 1000 hours without load and then stored at room temperature and humidity for one to two hours. Thereafter, the change of V_c shall be measured.																	
	Temperature cycle	<table border="1"> <thead> <tr> <th>Step</th> <th>Temperature (°C)</th> <th>Period (minutes)</th> </tr> </thead> <tbody> <tr> <td>1</td> <td>-25\pm3</td> <td>30⁺³_{..0}</td> </tr> <tr> <td>2</td> <td>Room Temp.</td> <td>3 max.</td> </tr> <tr> <td>3</td> <td>85\pm2</td> <td>30⁺³_{..0}</td> </tr> <tr> <td>4</td> <td>Room Temp.</td> <td>3 max.</td> </tr> </tbody> </table>		Step	Temperature (°C)	Period (minutes)	1	-25 \pm 3	30 ⁺³ _{..0}	2	Room Temp.	3 max.	3	85 \pm 2	30 ⁺³ _{..0}	4	Room Temp.	3 max.	$\Delta V_{1mA}/V_{1mA} \leq \pm 5 \%$ No remarkable damage
		Step	Temperature (°C)	Period (minutes)															
1	-25 \pm 3	30 ⁺³ _{..0}																	
2	Room Temp.	3 max.																	
3	85 \pm 2	30 ⁺³ _{..0}																	
4	Room Temp.	3 max.																	
Dry heat load/ high temperature load	After being continuously applied the Maximum Allowable Voltage at 85 \pm 2 °C for 500 hours, the specimen shall be stored at room temperature and humidity for one to two hours. Thereafter, the change of V_c shall be measured.	$\Delta V_{1mA}/V_{1mA} \leq \pm 10 \%$																	

Minimum quantity / Packing unit

Product	Series / Type		Part number	Minimum quantity / Packing unit	Packing quantity in carton	Carton (about) L×W×H (mm)
"ZNR" Transient/surge absorbers	CK type	UL and CSA recognized	ERZC□□CK□□□W	10	200	320×430×65

Part No., quantity and country of origin are designated on outer packages in English.

※ Please contact local sales office about packing specifications.

Safety and Legal Matters to Be Observed

Product specifications and applications

- Please be advised that this product and product specifications are subject to change without notice for improvement purposes. Therefore, please request and confirm the latest delivery specifications that explain the specifications in detail before the final design, or purchase or use of the product, regardless of the application. In addition, do not use this product in any way that deviates from the contents of the company's delivery specifications.
- Unless otherwise specified in this catalog or the product specifications, this product is intended for use in general electronic equipment (AV products, home appliances, commercial equipment, office equipment, information and communication equipment, etc.).
When this product is used for the following special cases, the specification document suited to each application shall be signed/sealed (with Panasonic and the user) in advance..These include applications requiring special quality and reliability, wherein their failures or malfunctions may directly threaten human life or cause harm to the human body (e.g.: space/aircraft equipment, transportation/traffic equipment, combustion equipment, medical equipment, disaster prevention/crime prevention equipment, safety equipment, etc.).

Safety design and product evaluation

- Please ensure safety through protection circuits, redundant circuits, etc., in the customer's system design so that a defect in our company's product will not endanger human life or cause other serious damage.
- This catalog shows the quality and performance of individual parts. The durability of parts varies depending on the usage environment and conditions. Therefore, please ensure to evaluate and confirm the state of each part after it has been mounted in your product in the actual operating environment before use.
If you have any doubts about the safety of this product, then please notify us immediately, and be sure to conduct a technical review including the above protection circuits and redundant circuits at your company.

Laws / Regulations / Intellectual property

- The transportation of dangerous goods as designated by UN numbers, UN classifications, etc., does not apply to this product. In addition, when exporting products, product specifications, and technical information described in this catalog, please comply with the laws and regulations of the countries to which the products are exported, especially those concerning security export control.
- Each model of this product complies with the RoHS Directive (Restriction of the use of hazardous substances in electrical and electronic equipment) (2011/65/EU and (EU) 2015/863). The date of compliance with the RoHS Directive and REACH Regulation varies depending on the product model.
Further, if you are using product models in stock and are not sure whether or not they comply with the RoHS Directive or REACH Regulation, please contact us by selecting "Sales Inquiry" from the inquiry form.
- During the manufacturing process of this product and any of its components and materials to be used, Panasonic does not intentionally use ozone-depleting substances stipulated in the Montreal Protocol and specific bromine-based flame retardants such as PBBs (Poly-Brominated Biphenyls) / PBDEs (Poly-Brominated Diphenyl Ethers). In addition, the materials used in this product are all listed as existing chemical substances based on the Act on the Regulation of Manufacture and Evaluation of Chemical Substances.
- With regard to the disposal of this product, please confirm the disposal method in each country and region where it is incorporated into your company's product and used.
- The technical information contained in this catalog is intended to show only typical operation and application circuit examples of this product. This catalog does not guarantee that such information does not infringe upon the intellectual property rights of Panasonic or any third party, nor imply that the license of such rights has been granted.

Panasonic Industry will assume no liability whatsoever if the use of our company's products deviates from the contents of this catalog or does not comply with the precautions. Please be advised of these restrictions.

Matters to Be Observed When Using This Product (E / CK / SC-type)

Safety measures

An abnormal state of E-Type, CK-type, and SC-type varistors (ZNR surge absorber, hereinafter "the product" or "the surge absorber") that results from a problem with service conditions (materials used, the surrounding environment, power conditions, circuit conditions, etc.) may cause a fire accident, electric shock accident, burn accident, or product failure. Matters to note when handling this product will hereinafter be described. What is described below should be checked sufficiently before the product is used.

■ Confirming rated capabilities

Use the surge absorber within the range of its rated capabilities. Each type of surge absorber has specified rated capabilities including a maximum allowable circuit voltage, a surge current tolerance, an energy tolerance, an impulse lifespan (surge lifespan), average pulse power, and a service temperature. Using the surge absorber under severe service conditions that are beyond the rated capabilities causes degraded performance of the surge absorber or destruction of a circuit element, which may lead to smoke generation, ignition, etc.

■ Take the following measures in order to avoid an accident caused by expected phenomenon.

- (1) Destruction of the surge absorber may scatter its fractured pieces around. To protect other elements from these pieces, set product in a case or shield it with a cover.
- (2) Do not place the surge absorber near combustible materials (vinyl cable, resin mold, etc.). If avoiding the vicinity of combustible materials is difficult, protect the combustible material with an incombustible cover.
- (3) Surge absorber placed between lines
When the surge absorber is placed between lines, connect a normal type current fuse in series with the surge absorber.
* See "Current fuse" in the "Circuit design and circuit board design" section.
- (4) Surge absorber placed between a line and the ground
 - ① When the surge absorber is placed between a line and the ground, even if the surge absorber short-circuits, ground resistance will remain in the section between the line and the ground, leaving a possibility that the current fuse won't blow, in which case the outer sheath resin of the surge absorber may generate smoke or ignite due to current flow. To prevent such a case, place an earth leakage breaker in a location closer to the power supply than the surge absorber. When not using an earth leakage breaker, use a current fuse and temperature fuse in series with each other.
* See Table 1 in the "Circuit design and circuit board design" section.
 - ② When the surge absorber is placed between a live part and a metal case, it may cause electric shock if the surge absorber short-circuits. To avoid this, ground the metal case or shield it to prevent direct contact with the metal case.

■ In case the surge absorber should short-circuit and generate smoke or ignite, immediately cut off current flow to the surge absorber.

■ Rated voltage for UL certification, etc.

To allow the surge absorber to meet leak current requirements, etc., a maximum allowable circuit voltage and rated voltage are specified for the surge absorber.

When applying for UL certification, etc. of a device equipped with a surge absorber, ensure the working voltage of the device does not exceed the rated voltage of the surge absorber.

■ An unexpected sharp rise in the working voltage, an incoming excessive surge, etc., may cause the surge absorber to generate smoke or ignite.

In such a case, fire spreading through the device should be prevented to avoid expanded damage. To achieve this, take a multi-protection measure, such as adopting fire-resistant materials that make up the outer shell components and structural materials.

Use environments and cleaning conditions

- Do not use the surge absorber in an outdoor environment where the surge absorber is exposed to sunlight.
- Do not use the surge absorber in which direct sunlight hits the surge absorber or near a heating element where the temperature of the surge absorber would rise above its working temperature.
- Do not use the surge absorber in a place where the surge absorber is exposed to wind or rain or a highly humid place where steam is emitted or dew concentrates.
- Do not use the surge absorber in a place filled with dust or salt, in an atmosphere contaminated with a corrosive gas, etc., or in liquids such as water, oil, chemical, or organic solvents.

- Do not wash the surge absorber with a solvent (thinner, acetone, etc.) that damages the outer sheath resin.

Response to anomalies and handling conditions

Be careful not to drop the surge absorber on the floor, etc. The product is likely to suffer mechanical or electrical damage when dropped on the floor. Avoid using such a product.

Reliability and product life

To know the detailed specifications of individual products or specific evaluation test scores, please contact us.

Circuit design and circuit board design

Meet the following requirements. Not following the requirements can result in a shorter lifespan of the surge absorber or its failure.

- Choose a surge absorber whose maximum allowable circuit voltage has a margin relative to the maximum voltage range including source voltage fluctuations.
 - * See Table 1 in the "Circuit design and circuit board design" section.
- When surges are applied intermittently to the surge absorber at short intervals (when pulses of voltages are applied in a noise simulator test, etc.), make sure that the surge power does not exceed the maximum average pulse power of the surge absorber.
- The product numbers of recommended surge absorbers to choose are shown in Table 1.

(1) The case of placing the surge absorber between lines

When the source voltage is expected to rise temporarily due to unbalanced single-wire loads in a three-phase three-wire connection configuration, a short circuit between a voltage line and a neutral line, loss of the neutral line, or resonance of a capacitive load caused by switching on/off, use a surge absorber (varistor) indicated by "*" in Table 1.

(2) The case of placing the surge absorber between a line and the ground

Line-to-ground voltage may rise with a single-wire ground fault, etc. Use a recommended surge absorber in Table 1 that is different from the surge absorber placed between lines. When the device is subjected to an insulation resistance test (500 V DC), use a surge absorber indicated by "*" in Table 1.

According to "Electrical Appliance Technical Standards" based on the Electrical Appliance and Material Safety Act, when using a varistor voltage which would fail the insulation performance test, the surge absorber may be removed from the device when being subjected to the test, depending on circuit test conditions.

* See attached table 4, appendix 4, "Electrical Appliance Technical Standards" based on the Electrical Appliance and Material Safety Act.

When conducting a withstand voltage test (1000 V AC) of the device, remove the surge absorber from the device after getting approval from the parties concerned.

■ Current fuse

(1) Select a surge absorber and fuses to use in as shown in the following table.

Confirm that no secondary accident arises when the surge absorber in an actual circuit breaks. Selected rated currents of current fuses shown in the following table are exemplary one and may vary depending on circuit conditions used. Confirm the rated current by a test, etc., before using the current fuse.

Series	ERZC 20EK□□□(□)	ERZC 32EK□□□(□)	ERZV S34C□□□	ERZC □□CK□□□W
Current fuse (placed between lines)	10 A max.	20 A max.	20 A max.	20 A max.
Temperature fuse (placed between a line and the ground)	100 to 120°C 5A	100 to 120°C 10A	100 to 120°C 10A	100 to 120°C 10A

* Use the rated voltage of the current fuse that corresponds to the circuit voltage of a circuit including the current fuse.

* Connect a temperature fuse directly to the terminal so that heat from the terminal is easily transferred to the fuse and that the fusing element of the fuse extends along its sides.

(2) Recommended parts where fuses are connected are shown in Table 1. When a load current to a protected device is so large as to exceed the rated current of the fuse, however, connect the fuse in a location shown in the following diagram.

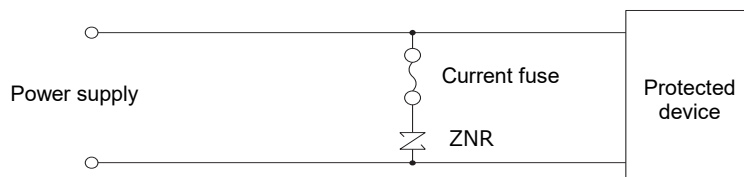
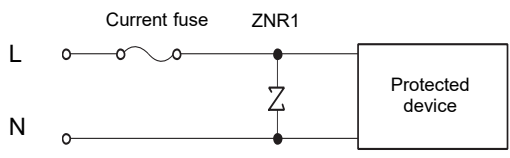
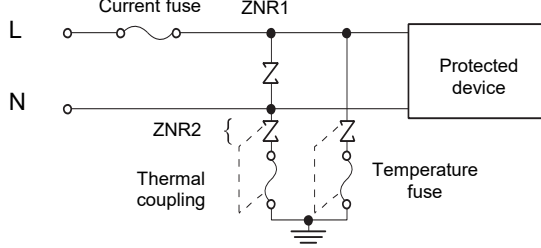
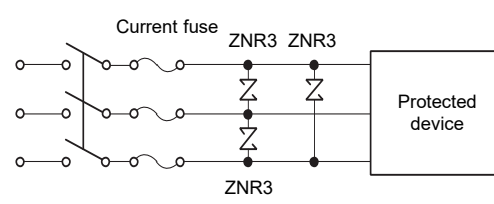
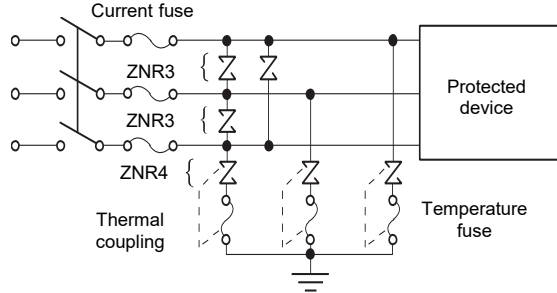

Table 1 Application example of the product (ordinary application example)

Connection	Surge absorber placed between lines	Surge absorber placed between a line and the ground																								
	<p>DC Single-phase AC</p> 	<p>DC Single-phase AC</p> 																								
<p>Three-phase AC</p> 			<p>Three-phase AC</p> 																							
Varistor voltage selection	<table border="1"> <thead> <tr> <th>ZNR</th> <th>Power supply voltage [AC]</th> <th colspan="2">Part number E, CK, SC-type</th> </tr> </thead> <tbody> <tr> <td rowspan="4">ZNR 1 ZNR 3</td> <td>100 V</td> <td rowspan="4">ERZC□□EK ERZC□□CK ERZVS34C</td> <td>201 to 361*</td> </tr> <tr> <td>120 V</td> <td>241 to 431*</td> </tr> <tr> <td>200 V to 220 V</td> <td>471 to 621*</td> </tr> <tr> <td>240 V</td> <td>511, 621*</td> </tr> </tbody> </table>	ZNR	Power supply voltage [AC]	Part number E, CK, SC-type		ZNR 1 ZNR 3	100 V	ERZC□□EK ERZC□□CK ERZVS34C	201 to 361*	120 V	241 to 431*	200 V to 220 V	471 to 621*	240 V	511, 621*	<table border="1"> <thead> <tr> <th>ZNR</th> <th>Power supply voltage [AC]</th> <th colspan="2">Part number E, CK, SC-type</th> </tr> </thead> <tbody> <tr> <td rowspan="2">ZNR 2 ZNR 4</td> <td>100V to 220 V</td> <td rowspan="2">ERZC□□EK ERZC□□CK ERZVS34C</td> <td>471 511 821 or higher**</td> </tr> <tr> <td>240 V</td> <td>511 821 or higher**</td> </tr> </tbody> </table>	ZNR	Power supply voltage [AC]	Part number E, CK, SC-type		ZNR 2 ZNR 4	100V to 220 V	ERZC□□EK ERZC□□CK ERZVS34C	471 511 821 or higher**	240 V	511 821 or higher**
	ZNR	Power supply voltage [AC]	Part number E, CK, SC-type																							
ZNR 1 ZNR 3	100 V	ERZC□□EK ERZC□□CK ERZVS34C	201 to 361*																							
	120 V		241 to 431*																							
	200 V to 220 V		471 to 621*																							
	240 V		511, 621*																							
ZNR	Power supply voltage [AC]	Part number E, CK, SC-type																								
ZNR 2 ZNR 4	100V to 220 V	ERZC□□EK ERZC□□CK ERZVS34C	471 511 821 or higher**																							
	240 V		511 821 or higher**																							
<p>* To find out about surge absorbers that can be used in an AC withstand voltage test, please contact us.</p>																										

Processing conditions

- Do not apply vibration, impact (drop impact, etc.), or pressure strong enough to crack the outer sheath resin or absorber body of the surge absorber.
- When coating the surge absorber with a resin or embedding it in a resin mold, avoid using a resin that degrades the surge absorber.
- Do not bend the surge absorber or apply force thereto close to the insulation cover of the lead terminal.
- Make the wire as short and straight as possible.

Mounting and storage conditions

- Do not melt solder or the insulation material making up the surge absorber when soldering the lead terminal.
- Do not keep the product in a high-temperature or high-humidity condition. Keep the surge absorber in a room with a temperature of 40 °C or lower and a relative humidity of 75% or lower and use the surge absorber within two years of storage.
- Keep the surge absorber in a place where no corrosive gas atmosphere (hydrogen sulfide, sulfurous acid, chlorine, ammonia, etc.) is present.
- Keep the surge absorber in a place where the surge absorber is protected from direct sunlight, dew concentration, etc.