

LMBD3004CLT1G

S-LMBD3004CLT1G

HIGH VOLTAGE SURFACE MOUNT SWITCHING DIODE

1. FEATURES

- We declare that the material of product compliance with RoHS requirements and Halogen Free.
- S- prefix for automotive and other applications requiring unique site and control change requirements; AEC-Q101 qualified and PPAP capable.
- Fast Switching Speed
- High Conductance
- High Reverse Breakdown Voltage Rating

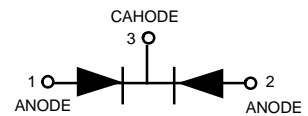
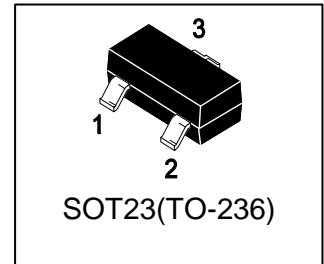

2. DEVICE MARKING AND RESISTOR VALUES

Device	Marking	Shipping
LMBD3004CLT1G	KAC	3000/Tape&Reel
LMBD3004CLT3G	KAC	10000/Tape&Reel

3. MAXIMUM RATINGS(Ta = 25°C)

Parameter	Symbol	Limits	Unit
Peak Repetitive Reverse Voltage	VRRM	350	V
Working Peak Reverse Voltage	VRWM	350	
DC Blocking Voltage	VR		
RMS Reverse Voltage	VR(RMS)	212	V
Forward Continuous Current (Note 1)	IF	225	mA
Repetitive Peak Forward Current (Note 1)	IFRM	625	mA
Non-Repetitive Peak Forward Surge Current t=1μs t=1s	IFSM	4 1	A

1. Part mounted on FR-4 board with recommended pad layout.

4. THERMAL CHARACTERISTICS

Parameter	Symbol	Limits	Unit
Total Device Dissipation, FR-4 Board (Note 2) @ TA = 25°C Derate above 25°C	PD	280 2.24	mW mW/°C
Thermal Resistance, Junction-to-Ambient(Note 2)	RθJA	446	°C/W
Junction and Storage temperature	TJ, Tstg	-65~+150	°C

2. FR-4 = 30.0mm×25.0mm×1.6mm, thickness of copper film:50 μm.

5. ELECTRICAL CHARACTERISTICS (Ta= 25°C)

CHARACTERISTICS	Symbol	Min	Typ.	Max	Unit
Reverse Breakdown Voltage(Note 3) (IR = 100 μ A)	VBR	350	-	-	V
Forward voltage(Note 3) (IF =20mA) (IF =100mA) (IF =200mA)	VF	- - -	0.78 0.93 1.03	0.87 1 1.25	V
Reverse Current(Note 3) (VR=240V) (VR=240V, Tj=150°C)	IR	- -	30 35	100 100	nA μ A
Total Capacitance (f=1MHz, VR =0)	CT	-	1	5	pF
Reverse Recovery Time (IF=IR=30mA, Irr=3.0mA, RL =100 Ω)	Trr	-	-	50	nS

3. Short duration test pulse used to minimize self-heating effect.

6.ELECTRICAL CHARACTERISTICS CURVES

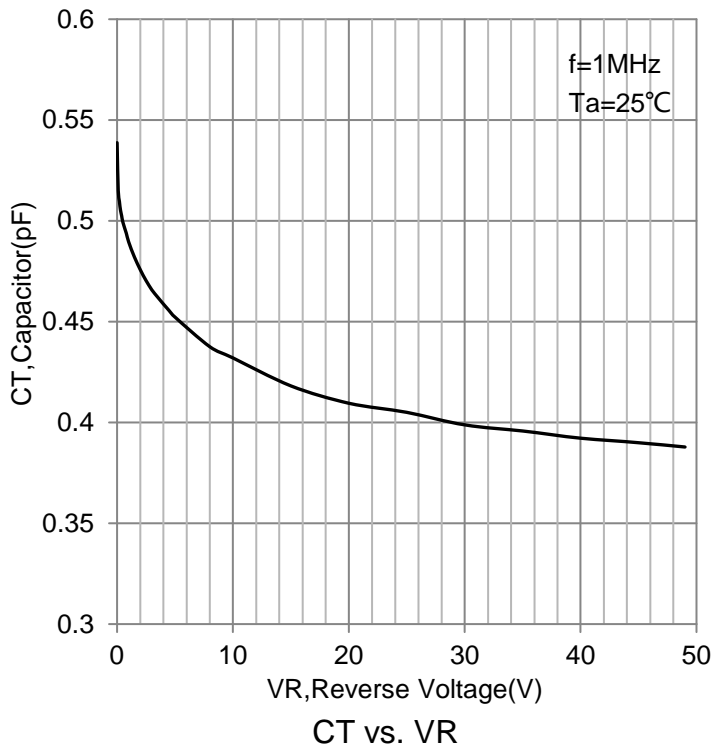
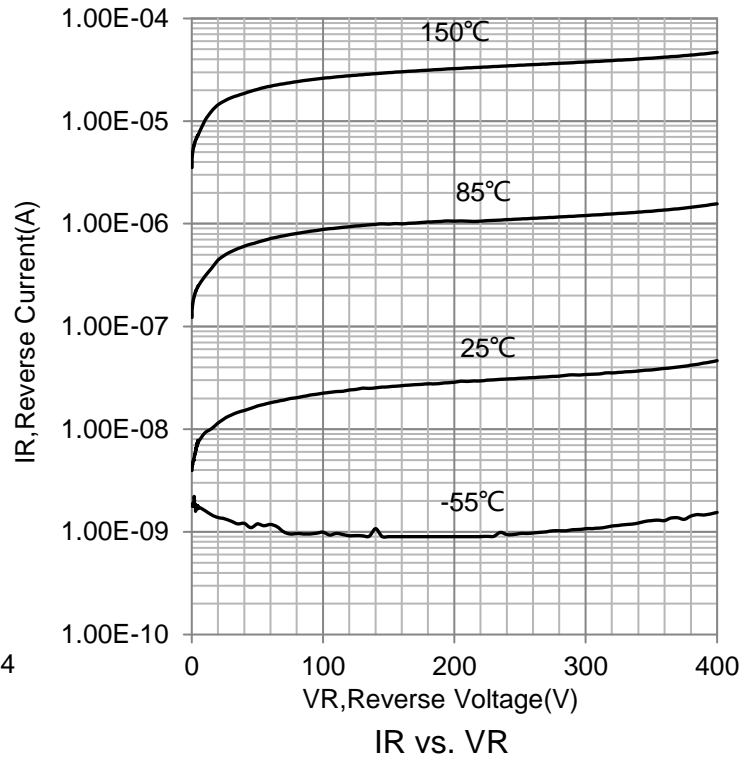
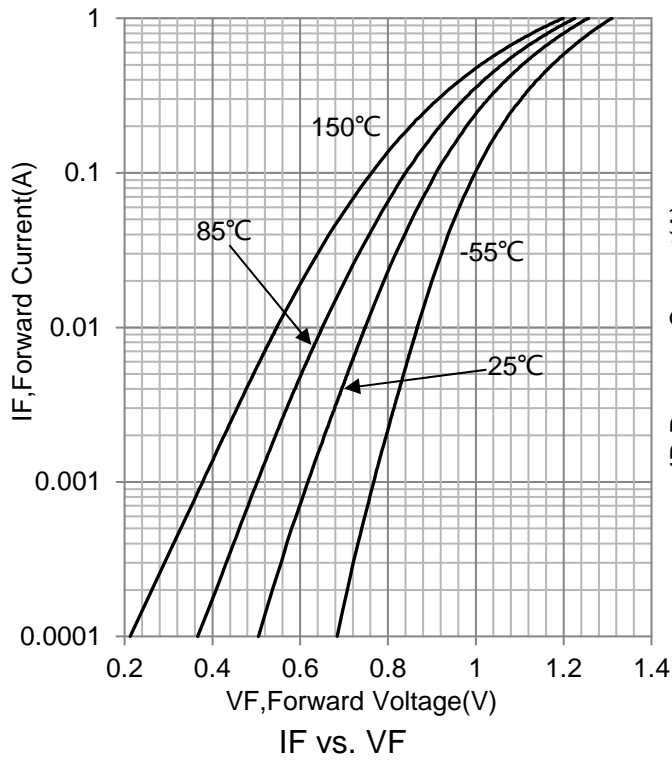

7. OUTLINE AND DIMENSIONS

Notes:

1. DIMENSIONING AND TOLERANCING PER ANSI Y14.5M, 1982.
2. CONTROLLING DIMENSION: MILLIMETERS.
3. MAXIMUM LEAD THICKNESS INCLUDES LEAD FINISH. MINIMUM LEAD THICKNESS IS THE MINIMUM THICKNESS OF BASE MATERIAL.
4. DIMENSIONS D AND E DO NOT INCLUDE MOLD FLASH, PROTRUSIONS OR GATE BURRS.

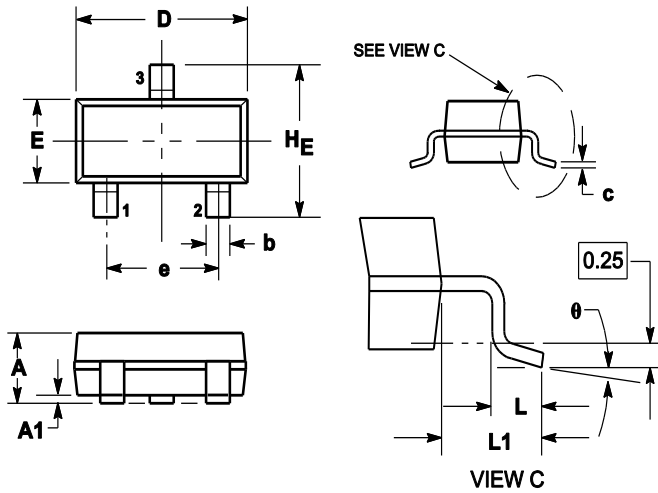

DIM	MILLIMETERS			INCHES		
	MIN	NOM	MAX	MIN	NOM	MAX
A	0.89	1	1.11	0.035	0.04	0.044
A1	0.01	0.06	0.1	0.001	0.002	0.004
b	0.37	0.44	0.5	0.015	0.018	0.02
c	0.09	0.13	0.18	0.003	0.005	0.007
D	2.80	2.9	3.04	0.11	0.114	0.12
E	1.20	1.3	1.4	0.047	0.051	0.055
e	1.78	1.9	2.04	0.07	0.075	0.081
L	0.10	0.2	0.3	0.004	0.008	0.012
L1	0.35	0.54	0.69	0.014	0.021	0.029
HE	2.10	2.4	2.64	0.083	0.094	0.104
theta	0°	---	10°	0°	---	10°

8. SOLDERING FOOTPRINT

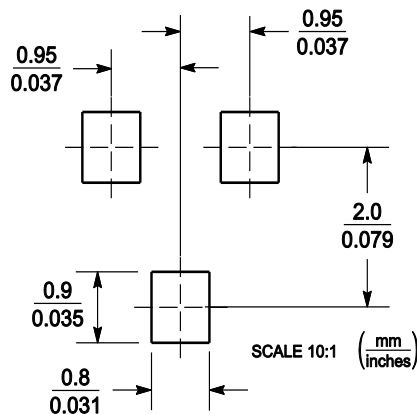

DISCLAIMER

- Before you use our Products, you are requested to carefully read this document and fully understand its contents. LRC shall not be in any way responsible or liable for failure, malfunction or accident arising from the use of any LRC's Products against warning, caution or note contained in this document.
- All information contained in this document is current as of the issuing date and subject to change without any prior notice. Before purchasing or using LRC's Products, please confirm the latest information with a LRC sales representative.