

For board-to-FPC

Narrow Pitch Connectors (0.35mm pitch)

S35 Series



New

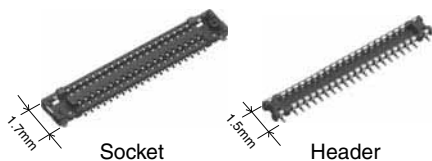

RoHS compliant

FEATURES

1. 1.7 mm wide slim two-piece type connector

Mated height 0.6 mm

Smaller compared to A4F series

• Width: Approx. 44% down

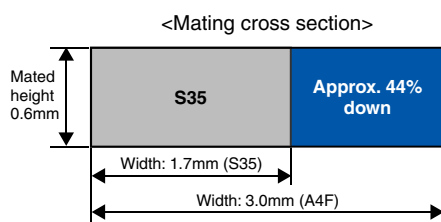

Mated height 0.8 mm

Smaller compared to A35S/A4S series

• Width: Approx. 32% down

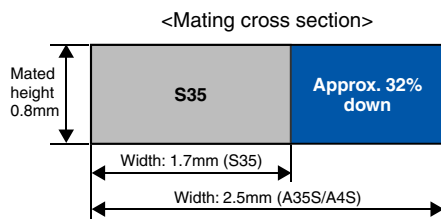

2. Low profile body: 0.6mm and 0.8mm mated height

3. Slim, low-profile construction with proprietary **TOUGH CONTACT** construction for both high contact reliability and easy implementation.

S35 (h = 0.6 mm)

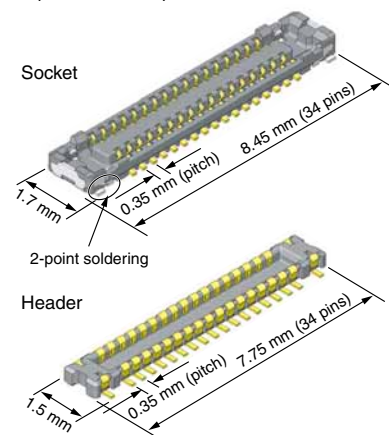

S35 (h = 0.8 mm)

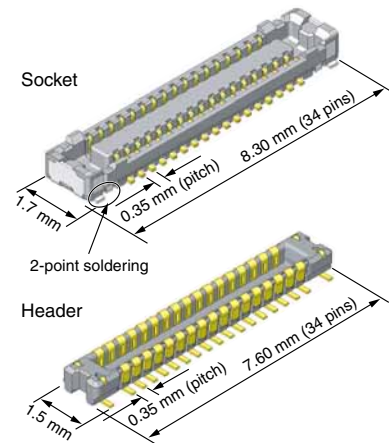

4. For 0.6 mm mated height, thanks to our proprietary “Fine fitting structure”, high removability with a nice click feel is maintained while being low profile.

APPLICATIONS

All types of board-to-FPC connection applications for miniature mobile devices such as wearable devices.

ORDERING INFORMATION

■ 0.6mm

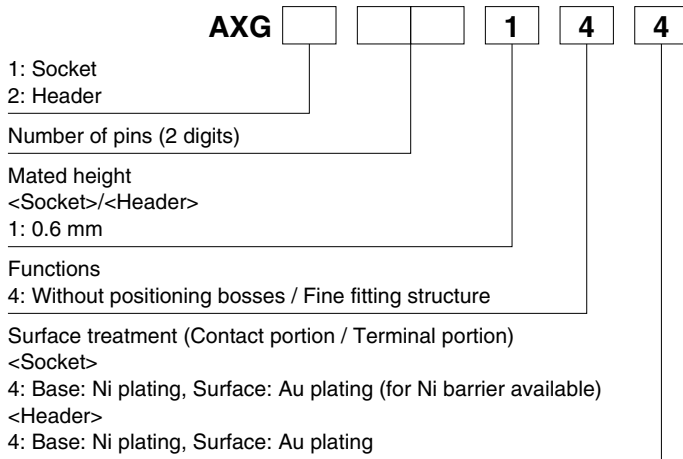

■ 0.8mm

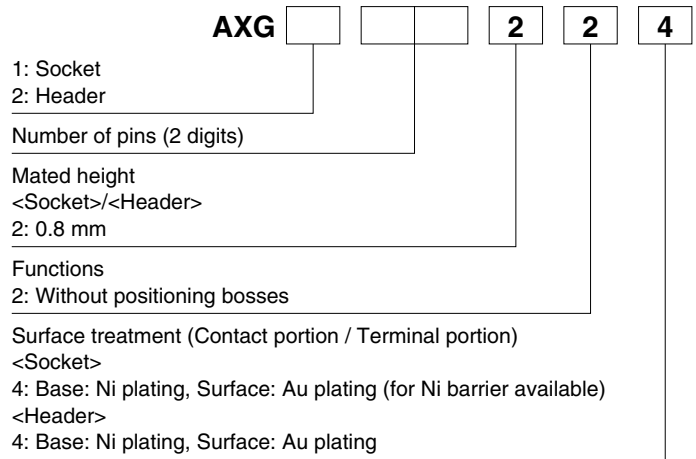

PRODUCT TYPES

Mated height	Number of pins	Part number		Packing	
		Socket	Header	Inner carton (1-reel)	Outer carton
0.6mm	6	AXG106144	AXG206144	15,000 pieces	30,000 pieces
	10	AXG110144	AXG210144		
	12	AXG112144	AXG212144		
	16	AXG116144	AXG216144		
	20	AXG120144	AXG220144		
	24	AXG124144	AXG224144		
	30	AXG130144	AXG230144		
	34	AXG134144	AXG234144		
	40	AXG140144	AXG240144		
	44	AXG144144	AXG244144		
	50	AXG150144	AXG250144		
54	AXG154144	AXG254144			
60	AXG160144	AXG260144			
0.8mm	12	AXG112224	AXG212224	15,000 pieces	30,000 pieces
	24	AXG124224	AXG224224		
	34	AXG134224	AXG234224		
	44	AXG144224	AXG244224		

Notes: 1. Order unit:

For volume production: 1-inner carton (1-reel) units

Samples for mounting check: 50-connector units. Please contact our sales office.

Samples: Small lot orders are possible. Please contact our sales office.

2. Please contact us for connectors having a number of pins other than those listed above.

SPECIFICATIONS

1. Characteristics

Item	Specifications	Conditions																	
Electrical characteristics	Rated current	Each pin: Max. 0.3 A (All pins can carry: Max. 5A)																	
	Rated voltage	60V AC/DC																	
	Breakdown voltage	150V AC for 1 minute	No short-circuiting or damage at a detection current of 1 mA when the specified voltage is applied for one minute.																
	Insulation resistance	Min. 1,000M Ω (Initial stage)	Using 250V DC megger (applied for 1 minute)																
	Contact resistance	Max. 90m Ω	According to the contact resistance measurement method of JIS C 5402																
Mechanical characteristics	Composite insertion force	<ul style="list-style-type: none"> • h = 0.6 mm 20 or less contacts: Max. 26.0N, Over 22 contacts: Max. 1.300 N/contact \times Number of contacts (Initial stage) • h = 0.8 mm Max. 1.300 N/contact \times Number of contacts (Initial stage) 																	
	Composite removal force	Min. 0.215N/contact \times Number of contacts																	
Environmental characteristics	Ambient temperature	-55°C to +85°C	No freezing at low temperatures. No dew condensation.																
	Soldering heat resistance	The initial specification must be satisfied electrically and mechanically	Max. peak temperature of 260°C Infrared reflow soldering (PC board surface temperature near connector terminals) Soldering iron 300°C within 5 sec. 350°C within 3 sec.																
	Storage temperature	-55°C to +85°C (Products only) -40°C to +50°C (Packaging structure)	No freezing at low temperatures. No dew condensation.																
	Thermal shock resistance (Header and socket mated)	After 5 cycles Insulation resistance: Min. 100M Ω , Contact resistance: Max. 90m Ω	Conformed to MIL-STD-202F, method 107G																
			<table border="1"> <thead> <tr> <th>Order</th> <th>Temperature (°C)</th> <th>Time (minutes)</th> </tr> </thead> <tbody> <tr> <td>1</td> <td>-55$\frac{0}{-3}$</td> <td>30</td> </tr> <tr> <td>2</td> <td>{</td> <td>Max. 5</td> </tr> <tr> <td>3</td> <td>85$\frac{+3}{0}$</td> <td>30</td> </tr> <tr> <td>4</td> <td>{</td> <td>Max. 5</td> </tr> <tr> <td></td> <td>-55$\frac{0}{-3}$</td> <td></td> </tr> </tbody> </table>	Order	Temperature (°C)	Time (minutes)	1	-55 $\frac{0}{-3}$	30	2	{	Max. 5	3	85 $\frac{+3}{0}$	30	4	{	Max. 5	
	Order	Temperature (°C)	Time (minutes)																
	1	-55 $\frac{0}{-3}$	30																
2	{	Max. 5																	
3	85 $\frac{+3}{0}$	30																	
4	{	Max. 5																	
	-55 $\frac{0}{-3}$																		
Humidity resistance (Header and socket mated)	After 120 hours Insulation resistance: Min. 100M Ω , Contact resistance: Max. 90m Ω	Conformed to MIL-STD-1344A, method 1002 Bath temperature 40 \pm 2°C, Humidity 90 to 95% R.H.																	
Salt water spray resistance (Header and socket mated)	After 24 hours Insulation resistance: Min. 100M Ω , Contact resistance: Max. 90m Ω	Conformed to MIL-STD-1344A, method 1001 Bath temperature 35 \pm 2°C, Salt water concentration 5 \pm 1%																	
H ₂ S resistance (Header and socket mated)	After 48 hours Contact resistance: Max. 90m Ω	Conformed to JEIDA-38-1984 Bath temperature 40 \pm 2°C, Gas concentration 3 \pm 1 ppm, Humidity 75 to 80% R.H.																	
Lifetime characteristics	Insertion and removal life	30 times • Contact resistance: Max. 90m Ω • Composite removal force: Min. 0.215 N/contact \times Number of contacts.	Repeated insertion and removal cycles of max. 200 times/hour																
Unit weight	34 pins Socket h = 0.6 mm: 0.01g, h = 0.8 mm: 0.02g 34 pins Header h = 0.6 mm: 0.01g, h = 0.8 mm: 0.01g																		

2. Material and surface treatment

Part name	Material	Surface treatment
Molded portion	Heat resistant plastic (LCP resin) (UL94V-0)	—
Contact and Post	Copper alloy	Contact portion (Main): Au plating (Min. 0.1 μ m) over nickel Contact portion (Sub): Au plating (Min. 0.05 μ m) over nickel Terminal portion: Au plating over nickel (except for top of the terminal) Soldering terminals (Socket): Pd + Au flash plating over nickel (except for top of the terminal) Soldering terminals (Header): Au plating over nickel (except for top of the terminal)

Narrow pitch connectors S35 (0.35mm pitch)

DIMENSIONS (Unit: mm)

The CAD data of the products with a **CAD Data** mark can be downloaded from: <http://industrial.panasonic.com/ac/e/>

Socket (Mated height: 0.6 mm)

CAD Data

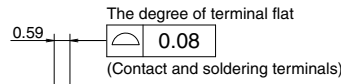
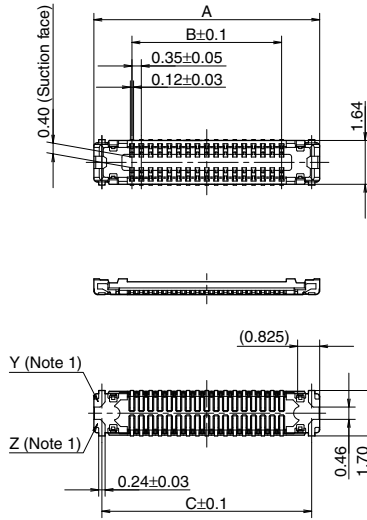

Dimension table (mm)

Number of pins/ dimension	A	B	C
6	3.55	0.70	2.95
10	4.25	1.40	3.65
12	4.60	1.75	4.00
16	5.30	2.45	4.70
20	6.00	3.15	5.40
24	6.70	3.85	6.10
30	7.75	4.90	7.15
34	8.45	5.60	7.85
40	9.50	6.65	8.90
44	10.20	7.35	9.60
50	11.25	8.40	10.65
54	11.95	9.10	11.35
60	13.00	10.15	12.40

General tolerance: ±0.2

Note: 1. Because the soldering terminal Y and Z are the unified structure, they are connected electrically.

Header (Mated height: 0.6 mm)

CAD Data

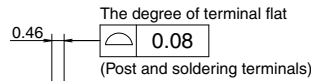
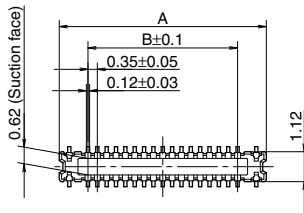

Dimension table (mm)

Number of pins/ dimension	A	B	C
6	2.85	0.70	2.10
10	3.55	1.40	2.80
12	3.90	1.75	3.15
16	4.60	2.45	3.85
20	5.30	3.15	4.55
24	6.00	3.85	5.25
30	7.05	4.90	6.30
34	7.75	5.60	7.00
40	8.80	6.65	8.05
44	9.50	7.35	8.75
50	10.55	8.40	9.80
54	11.25	9.10	10.50
60	12.30	10.15	11.55

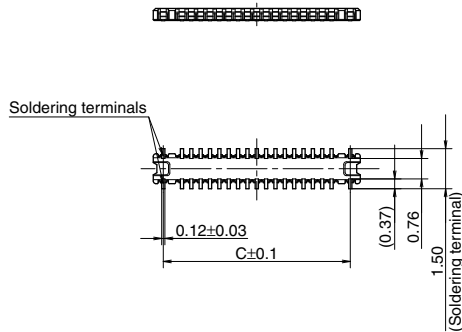

General tolerance: ±0.2

Socket (Mated height: 0.8 mm)

CAD Data

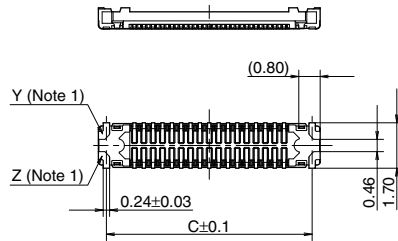
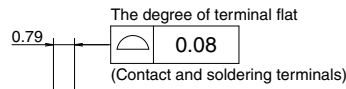
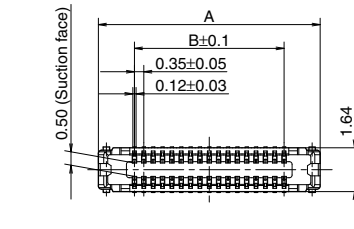

Dimension table (mm)

Number of pins/ dimension	A	B	C
12	4.45	1.75	3.85
24	6.55	3.85	5.95
34	8.30	5.60	7.70
44	10.05	7.35	9.45

General tolerance: ±0.2

Note: 1. Because the soldering terminal Y and Z are the unified structure, they are connected electrically.

Header (Mated height: 0.8 mm)

CAD Data

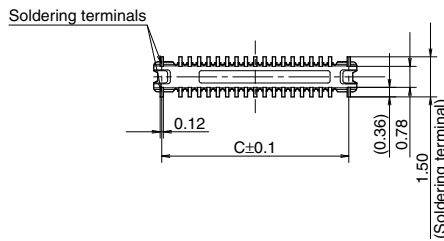
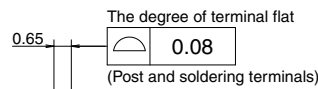
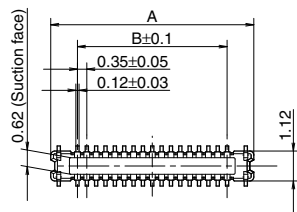

Dimension table (mm)

Number of pins/ dimension	A	B	C
12	3.75	1.75	3.15
24	5.85	3.85	5.25
34	7.60	5.60	7.00
44	9.35	7.35	8.75

General tolerance: ±0.2

Socket and Header are mated

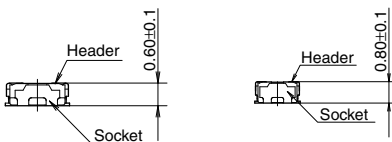

EMBOSSED TAPE DIMENSIONS (Unit: mm)

• Specifications for taping

(In accordance with JIS C 0806-3:1999. However, not applied to the mounting-hole pitch of some connectors.)

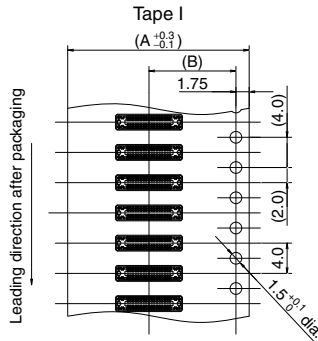

• Specifications for the plastic reel

(In accordance with EIAJ ET-7200B.)

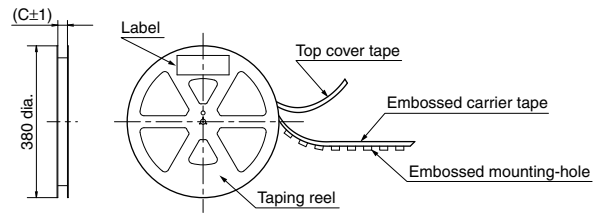

• Dimension table (Unit: mm)

Type/Mated height	Number of pins	Type of taping	A	B	C	Quantity per reel
Socket: 0.6mm and 0.8mm	Max. 30	Tape I	16.0	7.5	17.4	15,000
	34 to 60	Tape I	24.0	11.5	25.4	15,000
Header: 0.6mm and 0.8mm	Max. 34	Tape I	16.0	7.5	17.4	15,000
	40 to 60	Tape I	24.0	11.5	25.4	15,000

• Connector orientation with respect to embossed tape feeding direction

Direction of tape progress	Type	Common for S35	
	Socket		
	Header		

Note: There is no indication on this product regarding top-bottom or left-right orientation.

NOTES

1. Design of PC board patterns

Conduct the recommended foot pattern design, in order to preserve the mechanical strength of terminal solder areas.

2. Recommended PC board and metal mask patterns

Connectors are mounted with high pitch density, intervals of 0.35 mm, 0.4 mm or 0.5 mm.

In order to reduce solder and flux rise, solder bridges and other issues make sure the proper levels of solder is used.

The figures to the right are recommended metal mask patterns. Please use them as a reference.

• Socket (Mated height: 0.6 mm and 0.8 mm)

Recommended PC board pattern (TOP VIEW)

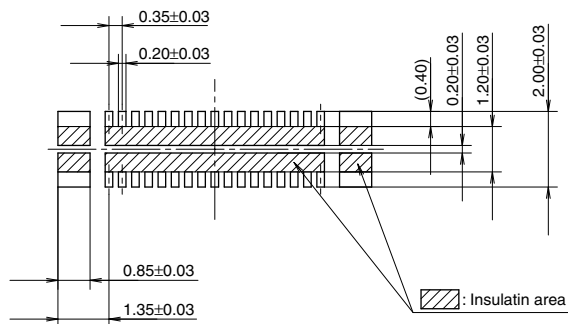

Recommended metal mask pattern

Metal mask thickness: When 100μm
(Terminal opening ratio: 70%)
(Metal-part opening ratio: 100%)

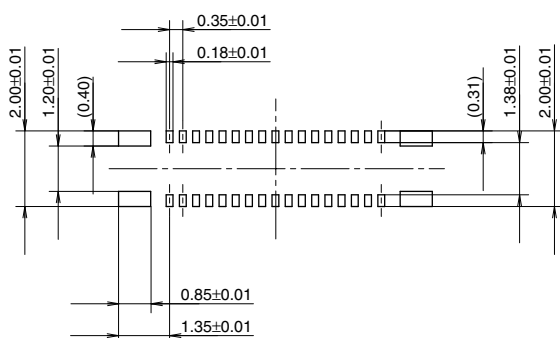

• Header (Mated height: 0.6 mm and 0.8 mm)

Recommended PC board pattern (TOP VIEW)

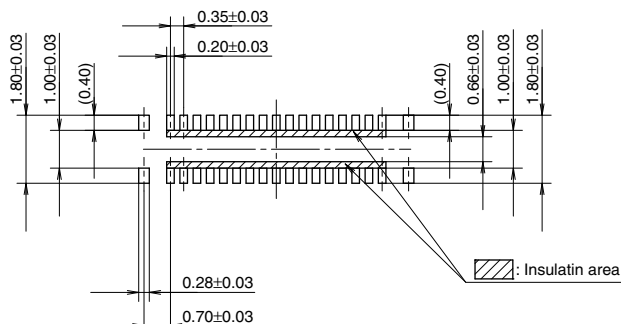

Recommended metal mask pattern

Metal mask thickness: When 100μm
(Terminal opening ratio: 70%)
(Metal-part opening ratio: 100%)

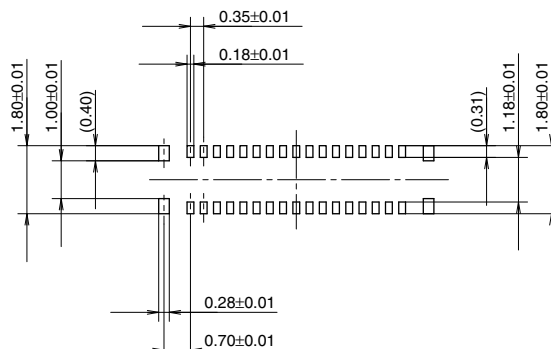

Please refer to the latest product specifications when designing your product.

Notes on Using Narrow pitch Connectors

Regarding the design of devices and PC board patterns

1) When connecting several connectors together by stacking, make sure to maintain proper accuracy in the design of structure and mounting equipment so that the connectors are not subjected to twisting and torsional forces.

2) With mounting equipment, there may be up to a ± 0.2 to 0.3-mm error in positioning. Be sure to design PC boards and patterns while taking into consideration the performance and abilities of the required equipment.

3) Some connectors have tabs embossed on the body to aid in positioning. When using these connectors, make sure that the PC board is designed with positioning holes to match these tabs.

4) To ensure the required mechanical strength when soldering the connector terminals, make sure the PC board meets recommended PC board pattern design dimensions given.

5) For all connectors of the narrow pitch series, to prevent the PC board from coming off during vibrations or impacts, and to prevent loads from falling directly on the soldered portions, be sure to design some means to fix the PC board in place.

Example) Secure in place with screws

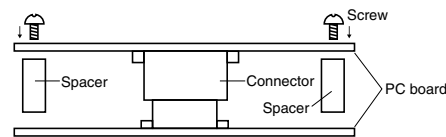

When connecting PC boards, take appropriate measures to prevent the connector from coming off.

6) Notes when using a FPC.

(1) When the connector is soldered to an FPC board, during its insertion and removal procedures, forces may be applied to the terminals and cause the soldering to come off. It is recommended to use a reinforcement board on the

backside of the FPC board to which the connector is being connected. Please make the reinforcement board dimensions bigger than the outer limits of the recommended PC board pattern (should be approximately 1 mm greater than the outer limit).

Material should be glass epoxy or polyimide, and the thickness should be between 0.2 and 0.3 mm.

(2) Collisions, impacts, or turning of FPC boards, may apply forces on the connector and cause it to come loose. Therefore, make to design retaining plates or screws that will fix the connector in place.

7) The narrow pitch connector series is designed to be compact and thin. Although ease of handling has been taken into account, take care when mating the connectors, as displacement or angled mating could damage or deform the connector.

Regarding the selection of the connector placement machine and the mounting procedures

1) Select the placement machine taking into consideration the connector height, required positioning accuracy, and packaging conditions.

2) Be aware that if the catching force of the placement machine is too great, it may deform the shape of the connector body or connector terminals.

3) Be aware that during mounting, external forces may be applied to the connector contact surfaces and terminals and cause deformations.

4) Depending on the size of the connector being used, self alignment may not be possible. In such cases, be sure to carefully position the terminal with the PC board pattern.

5) The positioning bosses give an approximate alignment for positioning on the PC board. For accurate positioning of the connector when mounting it to the PC board, we recommend using an automatic positioning machine.

6) Excessive mouter chucking force may deform the molded or metal part of the connector. Consult us in advance if chucking is to be applied.

Regarding soldering

1. Reflow soldering

- 1) Measure the recommended profile temperature for reflow soldering by placing a sensor on the PC board near the connector surface or terminals. (The setting for the sensor will differ depending on the sensor used, so be sure to carefully read the instructions that comes with it.)
- 2) As for cream solder printing, screen printing is recommended.
- 3) To determine the relationship between the screen opening area and the PC-board foot pattern area, refer to the diagrams in the recommended patterns for PC boards and metal masks. Make sure to use the terminal tip as a reference position when setting. Avoid an excessive amount of solder from being applied, otherwise, interference by the solder will cause an imperfect contact.

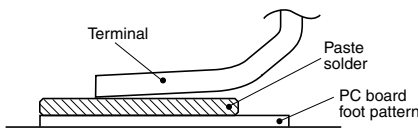

- 4) Consult us when using a screen-printing thickness other than that recommended.
- 5) When mounting on both sides of the PC board and the connector is mounting on the underside, use adhesives or other means to ensure the connector is properly fixed to the PC board. (Double reflow soldering on the same side is possible.)
- 6) N₂ reflow, conducting reflow soldering in a nitrogen atmosphere, increases the solder flow too greatly, enabling wicking to occur. Make sure that the solder feed rate and temperature profile are appropriate.

Soldering conditions

Please use the reflow temperature profile conditions recommended below for reflow soldering. Please contact us before using a temperature profile other than that described below (e.g. lead-free solder).

- Narrow pitch connectors (except P8 type)

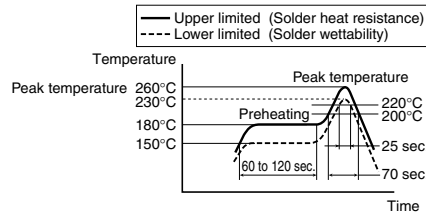

- Narrow pitch connector (P8)

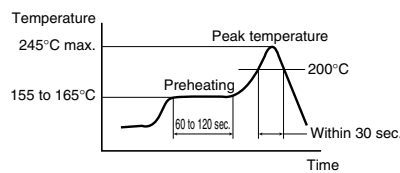

For products other than the ones above, please refer to the latest product specifications.

- 7) The temperatures are measured at the surface of the PC board near the connector terminals. (The setting for the sensor will differ depending on the sensor used, so be sure to carefully read the instructions that comes with it.)
- 8) The temperature profiles given in this catalog are values measured when using the connector on a resin-based PC board. When performed reflow soldering on a metal board (iron, aluminum, etc.) or a metal table to mount on a FPC, make sure there is no deformation or discoloration of the connector beforehand and then begin mounting.
- 9) Consult us when using a screen-printing thickness other than that recommended.
- 10) Some solder and flux types may cause serious solder or flux creeping. Solder and flux characteristics should be taken into consideration when setting the reflow soldering conditions.

2. Hand soldering

- 1) Set the soldering iron so that the tip temperature is less than that given in the table below.

Table A

Product name	Soldering iron temperature
SMD type connectors	300°C within 5 sec. 350°C within 3 sec.

- 2) Do not allow flux to spread onto the connector leads or PC board. This may lead to flux rising up to the connector inside.
- 3) Touch the soldering iron to the foot pattern. After the foot pattern and connector terminal are heated, apply the solder wire so it melts at the end of the connector terminals.

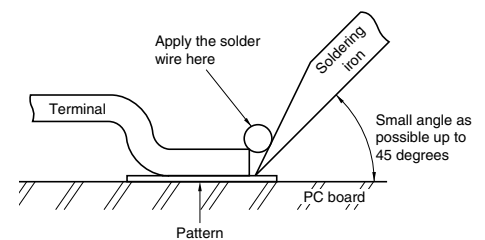

- 4) Be aware that soldering while applying a load on the connector terminals may cause improper operation of the connector.
- 5) Thoroughly clean the soldering iron.
- 6) Flux from the solder wire may get on the contact surfaces during soldering operations. After soldering, carefully check the contact surfaces and clean off any solder before use.
- 7) For soldering of prototype devices during product development, you can perform soldering at the necessary locations by heating with a hot-air gun by applying cream solder to the foot pattern beforehand. However, at this time, make sure that the air pressure does not move connectors by carefully holding them down with tweezers or other similar tool. Also, be careful not to go too close to the connectors and melt any of the molded components.
- 8) If an excessive amount of solder is applied during manual soldering, the solder may creep up near the contact points, or solder interference may cause imperfect contact.

3. Solder reworking

- 1) Finish reworking in one operation.
- 2) For reworking of the solder bridge, use a soldering iron with a flat tip. To prevent flux from climbing up to the contact surfaces, do not add more flux.
- 3) Keep the soldering iron tip temperature below the temperature given in Table A.

Handling Single Components

- 1) Make sure not to drop or allow parts to fall from work bench
- 2) Excessive force applied to the terminals could cause warping, come out, or weaken the adhesive strength of the solder. Handle with care.
- 3) Repeated bending of the terminals may cause terminals to break.

- 4) Do not insert or remove the connector when it is not soldered. Forcibly applied external pressure on the terminals can weaken the adherence of the terminals to the molded part or cause the terminals to lose their evenness.
- 5) Excessive prying-force applied to one end may cause product breakage and separation of the solder joints at the terminal.

Excessive force applied for insertion in a pivot action as shown may also cause product breakage. Align the header and socket positions before connecting them.

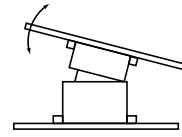

Cleaning flux from PC board

- 1) To increase the cleanliness of the cleaning fluid and cleaning operations, prepare equipment for cleaning process beginning with boil cleaning, ultrasonic cleaning, and then vapor cleaning.
- 2) Carefully oversee the cleanliness of the cleaning fluids to make sure that the contact surfaces do not become dirty from the cleaning fluid itself.

- 3) Since some powerful cleaning solutions may dissolve molded components of the connector and wipe off or discolor printed letters, we recommend aqua pura electronic parts cleaners. Please consult us if you wish to use other types of cleaning fluids.
- 4) Please note that the surfaces of molded parts may whiten when cleaned with alcohol.

Handling the PC board

• Handling the PC board after mounting the connector

When cutting or bending the PC board after mounting the connector, be careful that the soldered sections are subjected to excessive force.

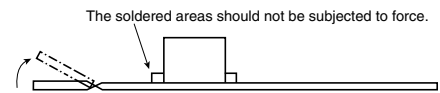

Storage of connectors

- 1) To prevent problems from voids or air pockets due to heat of reflow soldering, avoid storing the connectors in areas of high humidity. When storing the connectors for more than six months, be sure to consider storage area where the humidity is properly controlled.
- 2) Depending on the connector type, the color of the connector may vary from connector to connector depending on when it is produced.

- Some connectors may change color slightly if subjected to ultraviolet rays during storage. This is normal and will not affect the operation of the connector.
- 3) When storing the connectors with the PC boards assembled and components already set, be careful not to stack them up so the connectors are subjected to excessive forces.

- 4) Avoid storing the connectors in locations with excessive dust. The dust may accumulate and cause improper connections at the contact surfaces.

Other Notes

- 1) These products are made for the design of compact and lightweight devices and therefore the thickness of the molded components has been made very thin. Therefore, be careful during insertion and removal operations for excessive forces applied may damage the products.
- 2) Dropping of the products or rough mishandling may bend or damage the terminals and possibly hinder proper reflow soldering.

- 3) Before soldering, try not to insert or remove the connector more than absolutely necessary.
- 4) When coating the PC board after soldering the connector to prevent the deterioration of insulation, perform the coating in such a way so that the coating does not get on the connector.
- 5) There may be variations in the colors of products from different production lots. This is normal.

- 6) The connectors are not meant to be used for switching.
- 7) Be sure not to allow external pressure to act on connectors when assembling PCBs or moving in block assemblies.

Regarding sample orders to confirm proper mounting

When ordering samples to confirm proper mounting with the placement machine, connectors are delivered in 50-piece units in the condition given right. Consult a sale representative for ordering sample units.

Condition when delivered from manufacturing

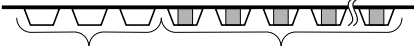

Embossed tape amount required for the mounting

Required number of products for sample production (Unit 50 pcs.)

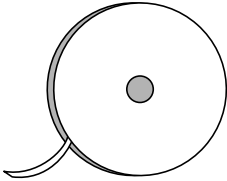

Reel

(Delivery can also be made on a reel by customer request.)

Please refer to the latest product specifications when designing your product.

Please contact

Panasonic Corporation

Automation Controls Business Division

■ Head Office: 1048, Kadoma, Kadoma-shi, Osaka 571-8686, Japan
industrial.panasonic.com/ac/e/

Panasonic[®]

© Panasonic Corporation 2014