

修 订 REV NO	标 记 MARK	修 改 描 要 REVISION DESCRIPTION	签 名 SIGNATURE	日 期 DATE
		NEW DWG		2016-03-12

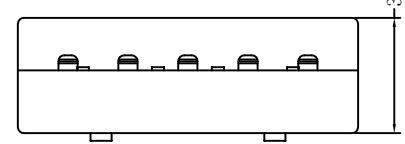
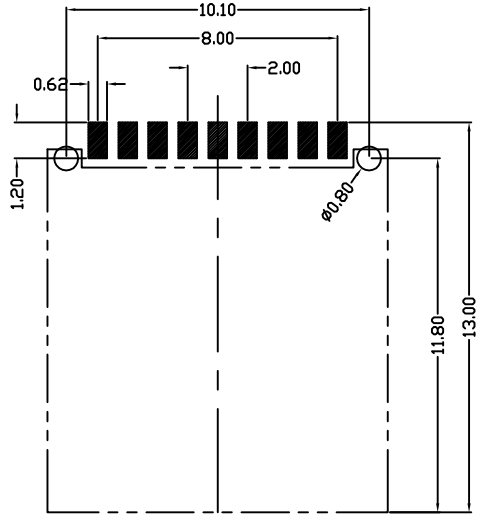
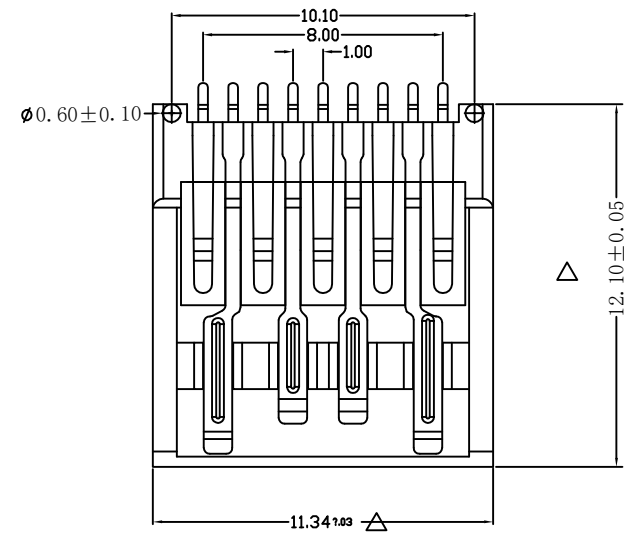
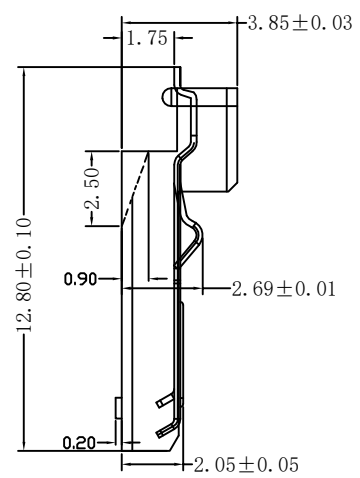

规格说明:Specifications:

电气特性:Electrical:

- 1.额定电流: Current Rating  
1.5A/contact terminal
- 2.额定电压: Voltage Rating  
30V DC
- 3.接触阻抗:Contact Resistance  
30 milliohms MAX
- 4.耐电压:Dielectnic Withstanding Voitage:  
500 V AC AT Sea Level
- 5.绝缘阻抗:Insulation Resistance:  
1000MEGA ohms MIN

物理性能:Mechanical:

- 1.插拔力: Cnnector Mate and Unmate Force  
Mate force:3.75kgf(MAX)  
Unmate force:1.02kgf(MIN)
- 2.端子保持力: Terminal Retenion  
1.2kgf(MIN)



原材料:Matorial:

- 1.塑胶:Housing:  
Hing Temperature Ternerplastics,  
Ul 94V-0 LCP
- 2.端子:Contact:Copper Alloy C5191
- 3.外壳:Shell: Copper Alloy C2680/SPCC

电镀:Finish:

- 1.端子:Contact: Plated Gold in Mating Area;  
Tin On Solder Talls
- 2.外壳:Shell:  
Nickel Plating

由 Autodesk 教育版产品制作

		深圳市华德共创科技有限公司 Shenzhen Huade co-create Technology Co.,LTD 电话: 0755-23304126 传真: 0755-29940187						
-TOLERANCES- UNLESS OTHERWISE SPECIFIED 公差参数表		 		TITLE: 产品名称: USB AM3.0手腕立脚				
X.X	±0.30	X.X*	±3°	APPD: 核准:	PART NO: 产品编号: USB-ZL-104PWB			
X.XX	±0.20	X.XX*	±2°	CHECK: 校对: 王建业	DATE	SCALE	UNIT	CODE NUMBER
X.XXX	±0.10	X.XXX*	±1°	DRAW: 绘图: 黄艳兰	2016-03-12	1:1	mm	A001

由 Autodesk 教育版产品制作