



# TO-220F Plastic-Encapsulate Transistors

## KTA1659A TRANSISTOR (PNP)

### FEATURES

- High Transition Frequency
- High Voltage Applications
- Complementary to KTC4370A

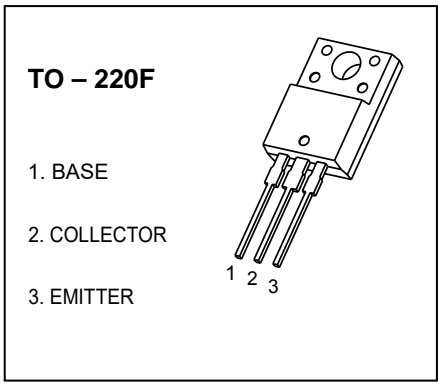

### MARKING

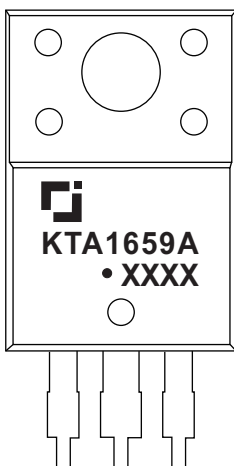

KTA1659A=Device code  
Solid dot=Green moldinn compound device,  
if none,the normal device  
XXXX=Code

### Equivalent Circuit

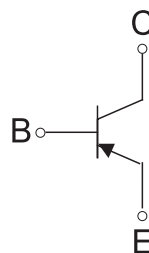

### MAXIMUM RATINGS (T<sub>a</sub>=25°C unless otherwise noted)

Symbol	Parameter	Value	Unit
V <sub>CBO</sub>	Collector-Base Voltage	-180	V
V <sub>CEO</sub>	Collector-Emitter Voltage	-180	V
V <sub>EBO</sub>	Emitter-Base Voltage	-5	V
I <sub>C</sub>	Collector Current	-1.5	A
P <sub>C</sub>	Collector Power Dissipation	2	W
R <sub>θJA</sub>	Thermal Resistance From Junction To Ambient	62.5	°C/W
T <sub>J</sub> , T <sub>stg</sub>	Operation Junction and Storage Temperature Range	-55~+150	°C

**ELECTRICAL CHARACTERISTICS ( $T_a=25^{\circ}\text{C}$  unless otherwise specified)**

Parameter	Symbol	Test conditions	Min	Typ	Max	Unit
Collector-base breakdown voltage	$V_{(BR)CBO}$	$I_C=-100\mu\text{A}, I_E=0$	-180			V
Collector-emitter breakdown voltage	$V_{(BR)CEO}$	$I_C=-10\text{mA}, I_B=0$	-180			V
Emitter-base breakdown voltage	$V_{(BR)EBO}$	$I_E=-1\text{mA}, I_C=0$	-5			V
Collector cut-off current	$I_{CBO}$	$V_{CB}=-160\text{V}, I_E=0$			-1	$\mu\text{A}$
Emitter cut-off current	$I_{EBO}$	$V_{EB}=-5\text{V}, I_C=0$			-1	$\mu\text{A}$
DC current gain	$h_{FE}$	$V_{CE}=-5\text{V}, I_C=-100\text{mA}$			240	
Collector-emitter saturation voltage	$V_{CE(sat)}$	$I_C=-500\text{mA}, I_B=-50\text{mA}$			-1.5	V
Base-emitter voltage	$V_{BE}$	$V_{CE}=-5\text{V}, I_C=-500\text{mA}$			-1	V
Collector output capacitance	$C_{ob}$	$V_{CB}=-10\text{V}, I_E=0, f=1\text{MHz}$		30		pF
Transition frequency	$f_T$	$V_{CE}=-10\text{V}, I_C=-100\text{mA}$		100		MHz

**CLASSIFICATION OF  $h_{FE}$** 

RANK	O	Y
RANGE	70-140	120-240

# Typical Characteristics

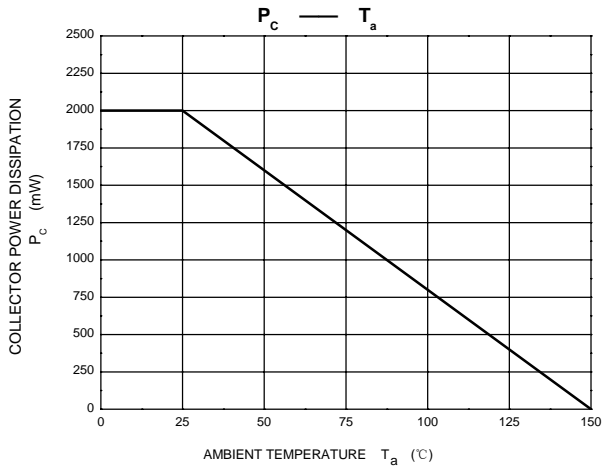
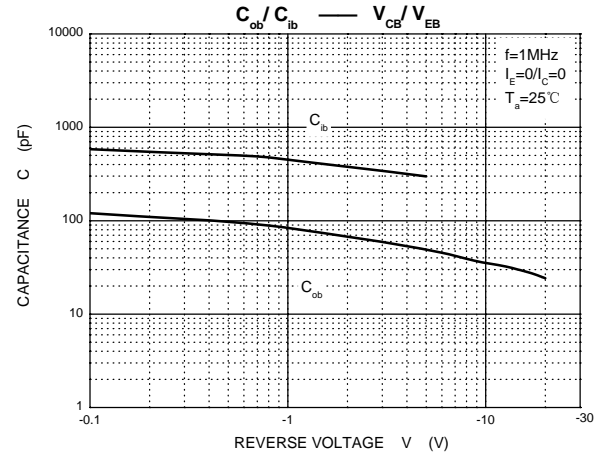
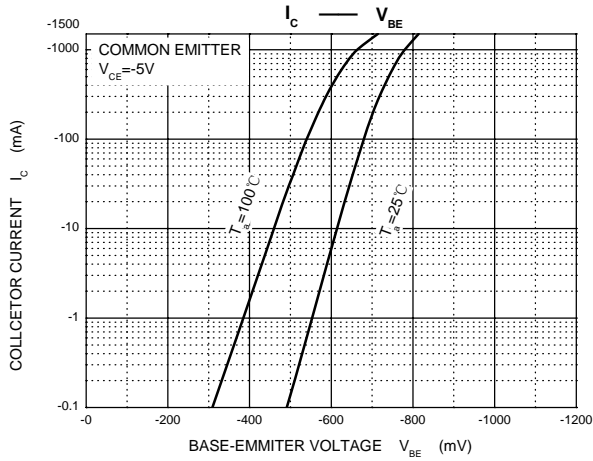
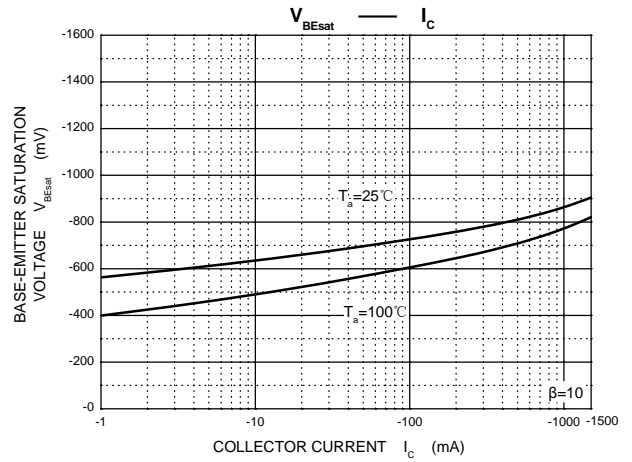
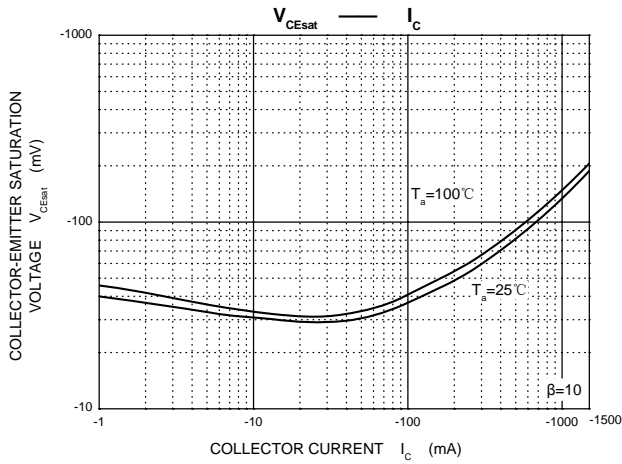
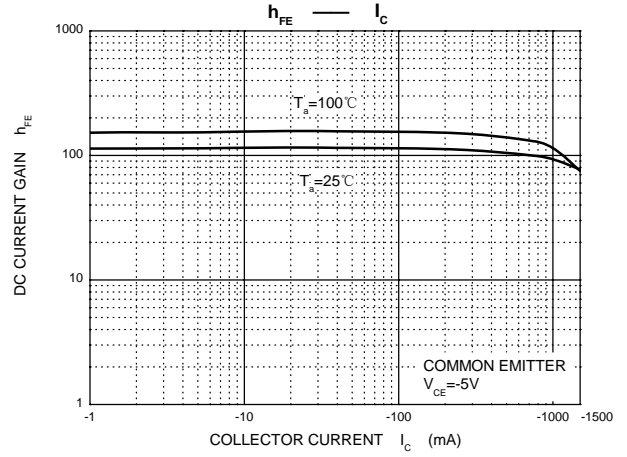
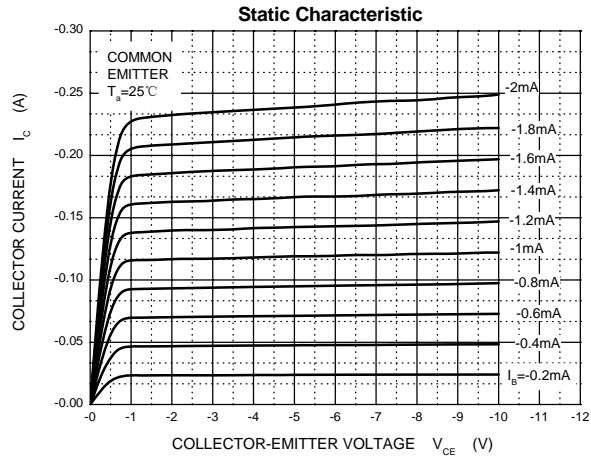

# TO-220F Package Outline Dimensions

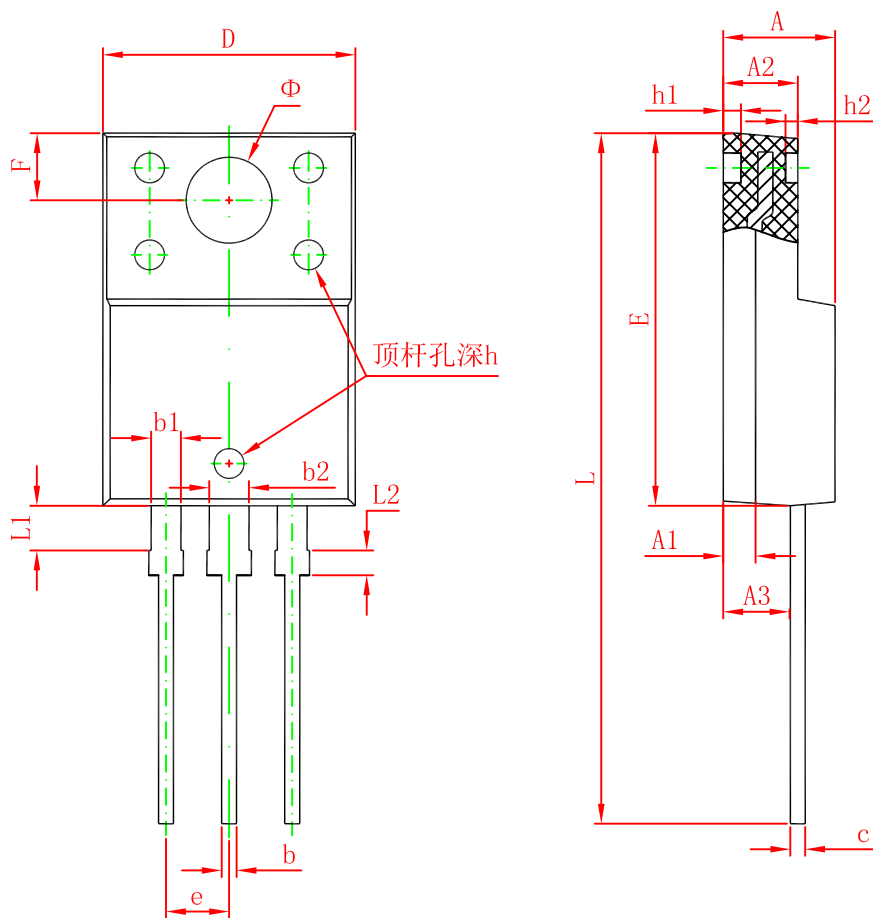

Symbol	Dimensions In Millimeters		Dimensions In Inches	
	Min.	Max.	Min.	Max.
A	4.300	4.700	0.169	0.185
A1	1.300 REF.		0.051 REF.	
A2	2.800	3.200	0.110	0.126
A3	2.500	2.900	0.098	0.114
b	0.500	0.750	0.020	0.030
b1	1.100	1.350	0.043	0.053
b2	1.500	1.750	0.059	0.069
c	0.500	0.750	0.020	0.030
D	9.960	10.360	0.392	0.408
E	14.800	15.200	0.583	0.598
e	2.540 TYP.		0.100 TYP.	
F	2.700 REF.		0.106 REF.	
Φ	3.500 REF.		0.138 REF.	
h	0.000	0.300	0.000	0.012
h1	0.800 REF.		0.031 REF.	
h2	0.500 REF.		0.020 REF.	
L	28.000	28.400	1.102	1.118
L1	1.700	1.900	0.067	0.075
L2	0.900	1.100	0.035	0.043