

P-Channel Enhancement-Mode MOSFET (-30V, -5.3A)

PRODUCT SUMMARY

V_{DSS}	I_D	$R_{DS(on)}$ (m Ω)TYP
-30V	-5.3A	50 @ $V_{GS} = -10V, I_D = -5.3A$
		70 @ $V_{GS} = -4.5V, I_D = -4.2A$

Features

- Advanced Trench Process Technology
- High Density Cell Design for Ultra Low On-Resistance
- Fully Characterized Avalanche Voltage and Current
- Improved Shoot-Through FOM
- Ordering information : ES9435 (Lead (Pb) -free and halogen-free)

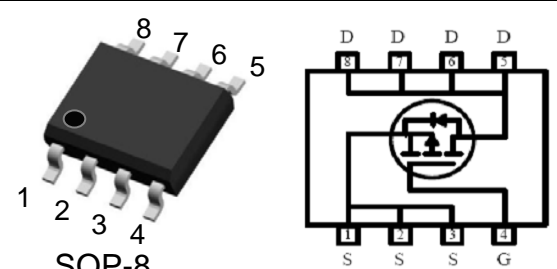
 <p>Pin1/2/3: Source Pin4: Gate Pin5/6/7/8: Drain</p>	<p>TOP Marking</p> <p>9 4 3 5 part number</p> <p>XXXXXX ID CODE</p>

Absolute Maximum Ratings ($T_A = 25^\circ\text{C}$, unless otherwise noted)

Symbol	Parameter	Rated	Units
V_{DS}	Drain-Source Voltage	-30	V
V_{GS}	Gate-Source Voltage	± 20	V
I_D	Drain Current (Continuous)	-5.3	A
I_{DM}	Drain Current (Pulsed) ^a	-20	A
P_D	Total Power Dissipation @ $T_A = 25^\circ\text{C}$	2.5	W
I_S	Maximum Diode Forward Current	-2.6	A
T_j, T_{stg}	Operating Junction and Storage Temperature Range	-55 to +150	$^\circ\text{C}$
R_{QJA}	Thermal Resistance Junction to Ambient (PCB mounted) ^b	60	$^\circ\text{C/W}$

a: Repetitive Rating: Pulse width limited by the maximum junction temperature.

b: 1-in² 2oz Cu PCB board

Electrical Characteristics (T_A=25°C, unless otherwise noted)

Symbol	Characteristic	Test Conditions	Min.	Typ.	Max.	Unit
• Off Characteristics						
BV _{DSS}	Drain-Source Breakdown Voltage	V _{GS} =0V, I _D =-250uA	-30	-	-	V
I _{DSS}	Zero Gate Voltage Drain Current	V _{DS} =-30V, V _{GS} =0V	-	-	-1	μA
I _{GSS}	Gate-Body Leakage Current	V _{GS} =±20V, V _{DS} =0V	-	-	±100	nA
• On Characteristics						
V _{GS(th)}	Gate Threshold Voltage	V _{DS} =V _{GS} , I _D =-250uA	-1	-1.4	-2	V
R _{DS(on)}	Drain-Source On-State Resistance	V _{GS} =-10V, I _D =-5.3A	-	50	60	mΩ
		V _{GS} =-4.5V, I _D =-4.2A	-	70	90	
• Dynamic Characteristics						
C _{iss}	Input Capacitance	V _{DS} =-15V, V _{GS} =0V, f=1MHz	-	553	-	PF
C _{oss}	Output Capacitance		-	93	-	
C _{rss}	Reverse Transfer Capacitance		-	63	-	
• Switching Characteristics						
Q _g	Total Gate Charge	V _{DS} =-15V, I _D =-5.3A, V _{GS} =-10V	-	9.86	-	nC
Q _{gs}	Gate-Source Charge		-	3.28	-	
Q _{gd}	Gate-Drain Charge		-	1.92	-	
t _{d(on)}	Turn-on Delay Time	V _{DD} =-15V, R _L =5Ω, I _D =-3A, V _{GEN} =-10V, R _G =6Ω	-	11	-	nS
t _r	Turn-on Rise Time		-	2.85	-	
t _{d(off)}	Turn-off Delay Time		-	23	-	
t _f	Turn-off Fall Time		-	3.2	-	
• Drain-Source Diode Characteristics						
V _{SD}	Drain-Source Diode Forward	V _{GS} =0V, I _S =-2.6A	-	-	-1.3	V

Note: Pulse Test: Pulse Width ≤ 300us, Duty Cycle ≤ 2%

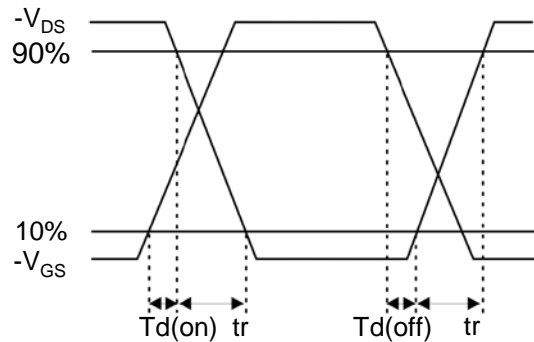
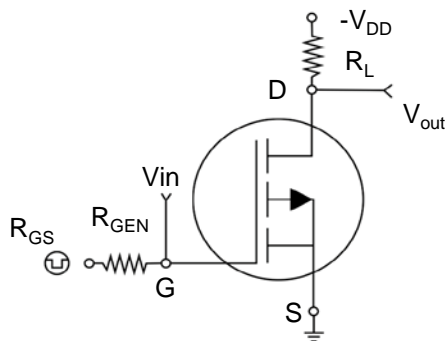

Switching Test Circuit and Switching Waveforms

Typical Characteristics Curves (Ta=25°C, unless otherwise note)

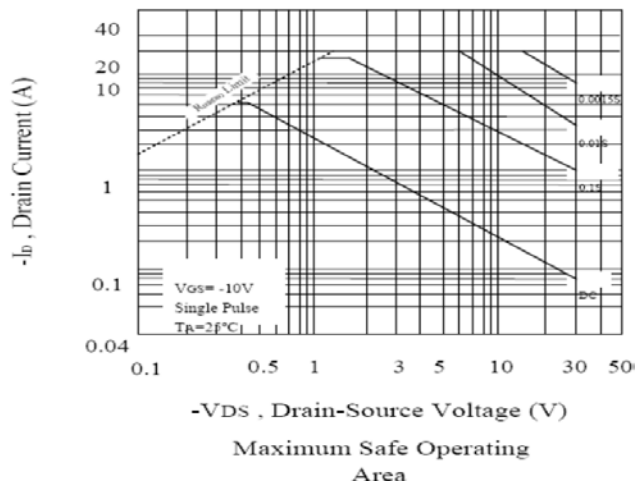
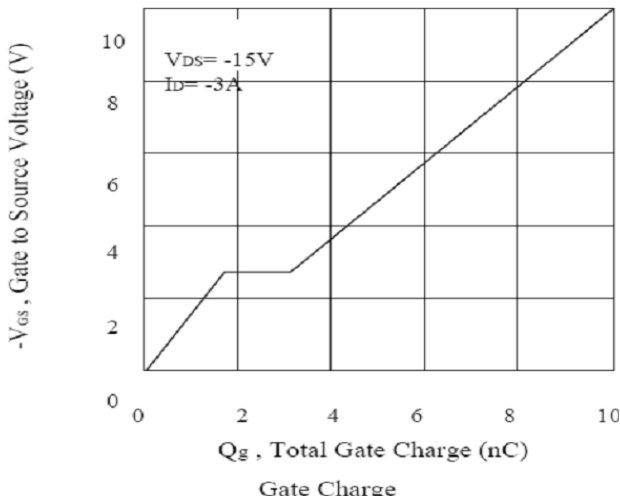
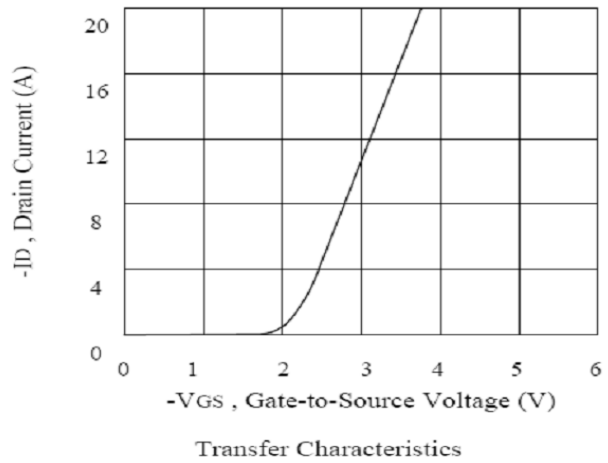
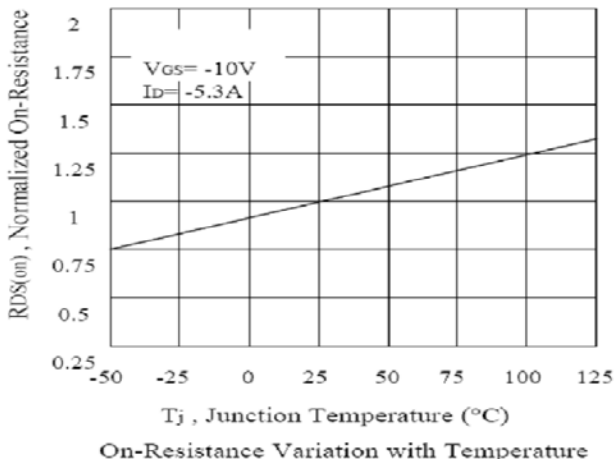
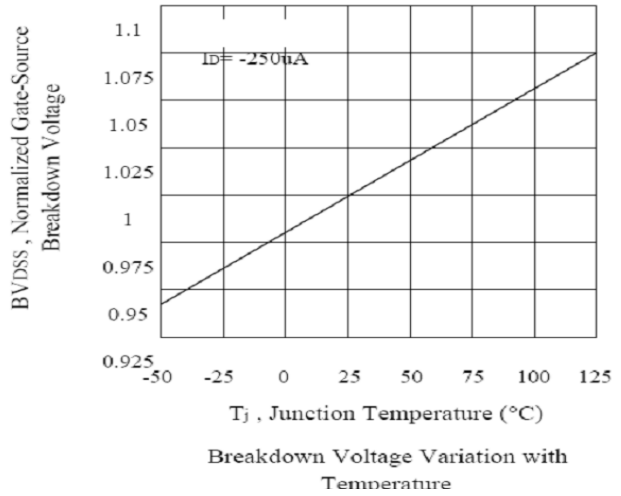
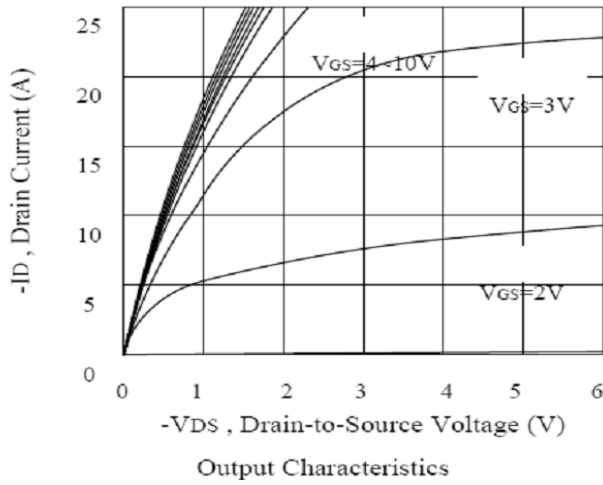

sop-8 PACKAGE OUTLINE DIMENSIONS

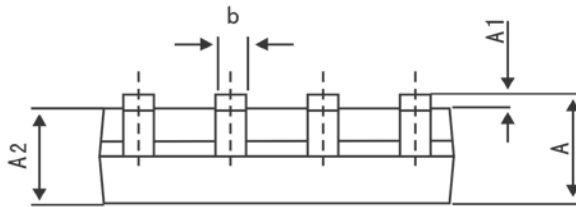
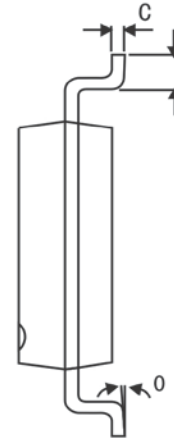
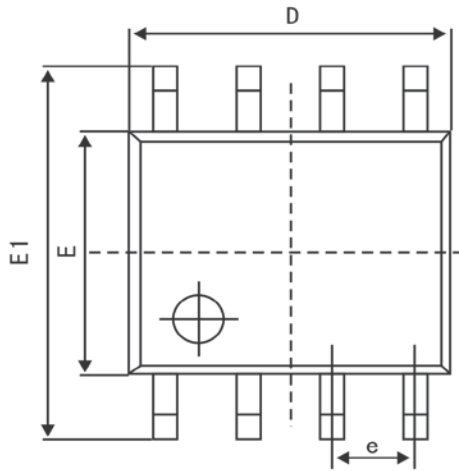

Symbol	Dimensions In Millimeters (MM)		Dimensions In Inches (MIL)	
	Min	Max	Min	Max
A	1.350	1.750	0.053	0.069
A1	0.100	0.250	0.004	0.010
A2	1.350	1.550	0.053	0.061
b	0.330	0.510	0.013	0.020
c	0.170	0.250	0.007	0.010
D	4.700	5.100	0.185	0.201
E	3.800	4.000	0.150	0.157
E1	5.800	6.200	0.228	0.244
e	1.270 (BSC)		0.050 (BSC)	
L	0.400	1.270	0.016	0.050
θ	0°	8°	0°	8°