

DATE: March 04,2019

SPECIFICATION

DESCRIPTION: Aluminium Electrolytic Capacitors

SERIES: MA



ITEM: 35 V 47 μ F (Φ 6.3 × 8)

CUSTOMER P/N:

No.: CRS-ZD-1903028

APPROVED BY

Please Return One Copy with Your Approval
承认后请寄回一份

PREPARED BY	CHECKED BY	APPROVED BY
		

尺寸DIMENSIONS [mm]

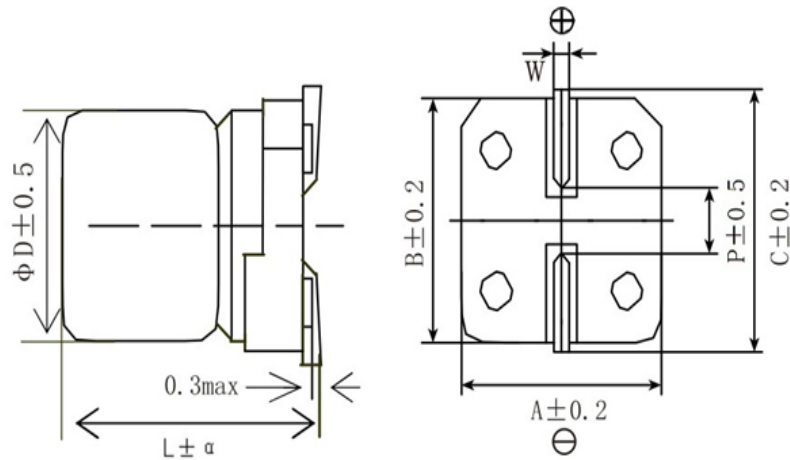

FIG-1

Size code	D	L	A	B	C	W	P	α
E83	6.3	8	6.6	6.6	7.2	0.5 to 0.8	1.9	0.5

特性 Characteristics

TABLE-1

No.	Customer Part No.	Aishi Part No.	Capacitance (μF)	Tolerance on Rated Capacitance (%)	Rated Voltage (Vdc)	Surge Voltage (Vdc)	Operating Temp. Range ($^{\circ}\text{C}$)	Tan δ (120Hz) (Max)	Leakage Current (μA) (2min.)	Max Ripple Current (mArms) at 105 $^{\circ}\text{C}$ 100kHz	Endurance at 105 $^{\circ}\text{C}$ (Hours)	Appearance Drawing No.
		1	47	-20,+20	35	44	-40~+105	0.14	49.35	140	10000	FIG-1

File Description	Approval Sheet						
Component P/N	MA	Version	01	Page	1		
STANDARD MANUAL							

1 概述 SCOPE

本承认书规定了MA系列贴片型铝电解电容器的技术规范，本技术规范条文解释权归本公司所有。

This specification covers "MA series" chip aluminium electrolytic capacitors, AISHI reserves the right of final interpretation technical specification.

2 参考标准 APPLICABLE SPECIFICATION

本承认书参考JIS-C-5101-1和JIS-C-5101-4制定。

This specification consulted the institute of JIS-C-5101-1 and JIS-C-5101-4.

3 工作温度范围 OPERATING TEMPERATURE RANGE

工作温度范围是电容器在施加额定工作电压条件下，可以长期可靠工作的环境温度范围。

Operating temperature range is the range of ambient temperature at which the capacitor can be operated continuously at rated voltage.

-40°C~+105°C 16V.DC~450V.DC

4 测试环境 CONDITION OF TEST

如果没有其他规定，标准的测试、检验环境条件如下所示：

环境温度：15°C~35°C

相对湿度：45%~75%

大气压力：86kPa~106kPa

如果对测试结果有异议，可以在以下条件测试：

环境温度：20±1°C

相对湿度：60%~67%

大气压力：86kPa~106kPa

Unless otherwise specified, the standard range of atmospheric conditions for making measurements and tests are as follows:

Ambient temperature : 15°C to 35°C

Relative humidity : 45% to 75%

Air pressure : 86kPa to 106kPa

If there may be doubt on the results, measurements shall be made within the following limits:

Ambient temperature : 20±1°C

Relative humidity : 60% to 67%

Air pressure : 86kPa to 106kPa

File Description	Approval Sheet				
Component P/N	MA	Version	01	Page	2
STANDARD MANUAL					

5 产品特性 PRODUCT CHARACTERISTICS

5.1 电气特性 Electrical Characteristics

序号 No.	项目 Item	测试方法 Test method	性能 Performance
5.1.1	额定工作电压 Rated voltage	电压：直流电压值+交流电压峰值≤额定电压 Voltage: DC voltage + peak ripple voltage ≤ Rated voltage	见表1 See TABLE-1
5.1.2	电容量 Capacitance	测试频率：120Hz(±20%) 测试电路：串联等效 测试电压：0.5Vrms以下+1.5~ 2.0VDC Measuring frequency: 120Hz±20% Measuring circuit: Series equivalent circuit Measuring voltage: 0.5Vrms or less +1.5 to 2.0 VDC	容量偏差：-20%~+20% Capacitance tolerance: -20%~+20%
5.1.3	损失角正切值 Dissipation factor	测试条件与5.1.2电容量测试相同。 Testing conditions are the same as 5.1.2 for capacitance.	DF见表1 DF: See TABLE-1
5.1.4	漏电流 Leakage current	<p>在电容器两端施加额定工作电压，并串联1000±100Ω电阻，在施加规定时间电压后，测量漏电流。</p> <p>测试电路如下图：</p> <p>The rated voltage shall be applied across the capacitor and its protective resistor shall be 1000±100Ω. The leakage current shall then be measured after an electrification period of schedule time. Measurement circuit:</p> <p>Rs: Protective resistor(1000±100Ω) DC ammeter DC voltmeter S1: Switch S2: Protective switch for an ammeter</p>	<p>16~100V $I \leq 0.03CV$ or 4μA 取较大值(2分钟后)</p> <p>16~100V $I \leq 0.03CV$ or 4μA Whichever is greater (after 2 min)</p> <p>160~450V: $I \leq 0.04CV + 100\mu A$, (1分钟后)</p> <p>160~450V: $I \leq 0.04CV + 100\mu A$, (after 1 min)</p> <p>I: 漏电流 (μA) C: 容量 (μF) V: 额定工作电压 (V) I: Leakage current(μA) C: Capacitance(μF) V: Rated voltage (V)</p>

File Description	Approval Sheet				
Component P/N	MA	Version	01	Page	3
STANDARD MANUAL					

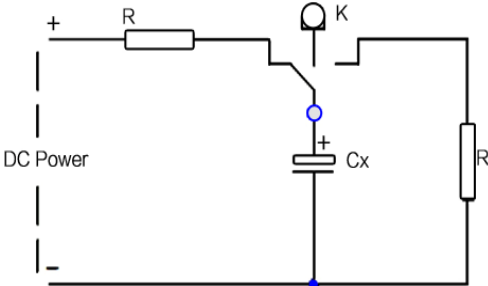
5.1.5	温度特性 Temperature characteristic	阶段	温度	时间	阶段2： 阻抗值与阶段1阻抗值相比，不大于表2要求； 阶段4： 容量变化应在初值的±20%范围内。 Step 2: Impedance value ratio to the value at step 1 shall be not more than the value given in TABLE-2. Step 4: Variation of capacitance Within ±20% of the initial value.
		1	20±2℃	--	
		2	-25, -40 ⁺¹⁰ ℃	2h	
		3	20±2℃	15min.	
		4	105 ⁺³ ℃	2h	
阶段1：测量容量和阻抗（ z 20℃ 120Hz±20%）； 阶段2：电容器恒温贮存2小时，在热平衡状态测阻抗（ z - 25, -40℃ 120Hz±20%）； 阶段4：电容器恒温贮存2小时，在热平衡状态测电容量。 Step 1: Capacitance and impedance shall be measured. (z 20℃ 120Hz±20%); Step 2: After the capacitor being stored for 2 hours, impedance shall be measured at thermal stability. (z -25, -40℃ 120Hz±20%); Step 4: After the capacitor being stored for 105℃ 2 hours, capacitance shall be measured. The measurement shall be made at thermal stability.					
5.1.6	耐浪涌电压 Surge test	施加表1所列浪涌电压，充电30±5秒，放电5.5±0.5分钟作为一个周期，共进行1000次。 测试温度：15℃-35℃ 然后在标准大气条件下放置达到热稳定，测试各参 Application of DC surge Voltage stated at TABLE-1. 1000 times of charging for 30±5 sec., discharging with a period of 5.5±0.5 min.. Test temperature: 15℃-35℃ And the capacitor shall be stored under standard atmospheric conditions to obtain thermal stability, after which measurements shall be made.			容量变化：在初始值的±20%以内。损耗角正切值不大于表1规定值的200%。 漏电流：满足5.1.4要求。 Capacitance change: Within ±20% of the initial value Dissipation factor: Not more than 200% of the specified value in TABLE-1. Leakage current: To satisfy No. 5.1.4 .
		Test circuit 			Note: This requirement is applicable only to instantaneous over voltage which may be applied to terminals of capacitor, therefore, not applicable to such over voltages as often applied.

File Description	Approval Sheet				
Component P/N	MA	Version	01	Page	4
STANDARD MANUAL					

5.2 机械特性 Mechanical Performance

序号 No.	项目 Item	测试方法 Test method	特性 Performance
5.2.1	振动试验 Resistance to vibration	<p>依据JISC 5101-1 4.17试验。 在3个互相垂直的方向分别施加2小时振动，共6小时。 频率：10-55Hz 振幅：1.5mm。 振速：1分钟内振速10~55~10Hz To comply with JIS C 5101-1 4.17 Direction and duration of vibration: 3 orthogonal directions mutually each for 2h , Total 6h. Vibration frequency range :10-55Hz. Peak to peak amplitude: 1.5mm Sweep rate :10 to 55 to 10Hz in about 1 min.</p>	<p>测量电容器应无接触不良开路或短路，无可见机械损伤。 When the capacitor is measured there shall be no intermittent contacts, or open or short circuiting. There shall be no visible mechanical damage.</p>
5.2.2	可焊性 Solderability	<p>依据JISC 5101-1 4.15进行试验。 焊锡温度：235±5℃ 浸入时间：2±0.5秒 To comply with JISC 5101-1 4.15 Temperature of solder: 235±5℃ Dipping time: 2±0.5sec. This specification shall be met after the capacitors are stored under standard atmospheric conditions for 6 months.</p>	<p>浸入焊锡的引线表面积约90%以上应附着新锡。 At least 90% of circumferential surface of the dipping portion of terminal shall be covered with new solder.</p>

File Description	Approval Sheet				
Component P/N	MA	Version	01	Page	5
STANDARD MANUAL					

5.3 耐久性测试 Endurance Performance

序号 No.	项目 Item	测试方法 Test method	特性 Performance				
5.3.1	无铅型回流焊 Lead free type reflow soldering	铝壳尺寸 $\Phi 6.3\sim\Phi 18\text{mm}$ Size $\Phi 6.3\sim\Phi 18\text{mm}$ 1) 电容器所处环境温度(空气温度)在 $T^{\circ}\text{C}$ 以下。 The ambient temperature(air temperature)shall not exceed $T^{\circ}\text{C}$. 2) 电容器所处环境温度(空气温度)在 200°C 以上的时间不能超过 t 秒, $T_1^{\circ}\text{C}$ 以上的时间不可超过 t_1 秒。 The period that the ambient temperature(air temperature)becomes more than 200°C and $T_1^{\circ}\text{C}$ shall not exceed t and t_1 seconds, respectively. 3) $\Phi 6.3\sim\Phi 10\text{mm}$: 预热控制在 $100^{\circ}\text{C}\sim 200^{\circ}\text{C}$, 180秒以内; $\Phi 12.5\sim\Phi 18\text{mm}$: 预热控制在 $100^{\circ}\text{C}\sim 180^{\circ}\text{C}$, 150秒以内。 Case size $\Phi 6.3\sim\Phi 10\text{mm}$: Preheat shall be made at $100^{\circ}\text{C}\sim 200^{\circ}\text{C}$ and for maximum 180 seconds. Case size $\Phi 12.5\sim\Phi 18\text{mm}$: Preheat shall be made at $100^{\circ}\text{C}\sim 180^{\circ}\text{C}$ and for maximum 150 seconds.	容量变化: 在初始值 $\pm 10\%$ 范围内 损失角正切值: 不大于规定值 漏电流: 满足5.1.4要求 外观: 无异状 Variation of capacitance: Within $\pm 10\%$ of the initial value Dissipation factor: Not more than the specified value Leakage current: To satisfy No.5.1.4 Appearance: No remarkable abnormality.				
		<p>峰值温度·5秒 Peak temperature · 5sec. $T^{\circ}\text{C Max.}$ T_1 t_1 sec. Max. t sec. Max. 100 预热 Preheat 时间 Time (sec.)</p>					
		Size	$T(^{\circ}\text{C})$ ①	$T_1(^{\circ}\text{C})$	$t(\text{sec})$ ②	$t_1(\text{sec})$ ③	Reflow cycle
		$\Phi 6.3$	250	230	90	40	1
		$\Phi 8$	250	230	90	30	1
		$\Phi 10$	250	230	60	30	1
$\Phi 12.5\sim\Phi 18$	250	230	60	30	1		
① 峰值温度Peak temperature ② 超过 200°C 的时间(max) Time more than 200°C ③ 超过 T_1 的时间Time more than T_1 出现超过允许条件的情况, 请联系我们。 Please contact us if the condition is over the maximum.							

File Description	Approval Sheet				
Component P/N	MA	Version	01	Page	6
STANDARD MANUAL					

序号 No.	项目 Item	测试方法 Test method	特性 Performance
5.3.2	稳态湿热 Resistance to damp heat (steady state)	<p>依据JISC 5101-1 4.22进行试验。 试验温度：40±2℃ 试验时间：240±8h 相对湿度：90~95% 试验后，电容器在标准大气条件下1~2小时，然后测试参数。</p> <p>Test time : 240±8h Relative humidity: 90~95% After completion of test, the capacitor shall be subjected to standard atmospheric conditions for 1 to 2 hours, after which measurements shall be made.</p>	<p>容量变化：在初始值±10%范围内。 损失角正切值：不大于表1规定值。 漏电流：满足5.1.4要求。 外观：无异状。</p> <p>Variation of capacitance: Within ±10% of the initial value. Dissipation factor: Not more than the specified value in TABLE-1. Leakage current: To satisfy No. 5.1.4 . Appearance: No remarkable abnormality.</p>
5.3.3	高温负荷试验 Load life test	<p>1. 试验温度：105±2℃,施加额定电压 Application of the rated voltage, test temperature:105±2℃</p> <p>2. 试验时间：参照TABLE-1寿命要求。 Testing time: refer to TABLE-1 life requirements.</p>	<p>1、16-100V 容量变化：初始值±30%范围内。 损耗角正切值：不超过规定值的300%。 漏电流：不大于规定值。 外观：无异状。</p> <p>Variation of capacitance: Within ±30% of the initial value. Dissipation factor: Not more than 300% of the specified value. Leakage current: Not more than the specified value. Appearance: No remarkable abnormality.</p> <p>2、160-450V 容量变化：初始值±20%范围内。 损耗角正切值：不超过规定值的200%。 漏电流：不大于规定值。 外观：无异状。</p> <p>Variation of capacitance: Within ±20% of the initial value. Dissipation factor: Not more than 200% of the specified value. Leakage current: Not more than the specified value. Appearance: No remarkable abnormality.</p>

File Description	Approval Sheet				
Component P/N	MA	Version	01	Page	7
STANDARD MANUAL					

5.3.4	高温贮存试验 Shelf life test	<p>在105±2℃环境下无负荷贮存1000⁺⁴⁸₋₀ h, 至少恢复16小时后。</p> <p>The capacitors are stored without voltage load at 105±2℃ for 1000⁺⁴⁸₋₀ h and then resumed 16 hours.</p>	<p>1、16-100V 容量变化：初始值±30%范围内。 损耗角正切值：不超过规定值的300%。 漏电流：不超过规定值的300%。 外观：无异状。 Variation of capacitance: Within ±30% of the value before test. Dissipation factor: Not more than 300% of the specified value. Leakage current: Not more than 300% of the specified value. Appearance: No remarkable abnormality.</p> <p>2、160-450V 容量变化：初始值±20%范围内。 损耗角正切值：不超过规定值的200%。 漏电流：不超过规定值的200%。 外观：无异状。 Variation of capacitance: Within ±20% of the value before test. Dissipation factor: Not more than 200% of the specified value. Leakage current: Not more than 200% of the specified value. Appearance: No remarkable abnormality.</p>
5.3.5	防爆试验 Safety vent	<p>在电容器两极施加反向直流电压，其中通过的电流为1 A，在测试时防爆装置应能在30分钟内动作。</p> <p>D. C. Application test The capacitor shall be subjected to a reverse D.C. voltage. The current flowing through the capacitor shall be 1A. If the vent does operate with the voltage applied for 30 minutes, the test is considered to be passed.</p>	<p>上述过程中应无引线、铝箔等散射，无火花产生。</p> <p>The safety vent is actuated under the test conditions, thereby preventing terminals, metal pieces, etc, of the capacitor from scattering due to burst, the case from separating from the seal packing, or the capacitor from producing flame.</p>

※ TABLE-2 : 阻抗比 Max. Impedance Ratio

额定工作电压 Rated voltage (Vdc)	16	25	35	50	63	80	100	160	200	250	400	450
z -25℃ / z 20℃	2							6				
z -40℃ / z 20℃	6	4	3					-				

※ TABLE-3 : 纹波电流频率因子 RIPPLE CURRENT FREQUENCY COEFFICIENT

Freq.(Hz)	120	1k	10k	100k
WV(Vdc)	0.50	0.80	0.90	1.00

File Description	Approval Sheet						
Component P/N	MA	Version	01	Page	8		
STANDARD MANUAL							

6 标记 MARKING

6.1 在电容器体上应注明如下内容：

- | | |
|------------|------------------------|
| (1) 生产厂商商标 | |
| (2) 型号 | MA 105℃ |
| (3) 周期代码 | YyWw (Yy表示年份，Ww表示制造周期) |
| | AAA |
| (4) 容量/电压 | --V |
| (5) 负极标志 | |

6.1 The Following Items Shall Be Marked Indelibly On The Capacitor:

- | | |
|---------------------------------------|--|
| (1) Manufacture's name or trade mark. | |
| (2) Series | MA 105℃ |
| (3) Date code | YyWw (Yy denotes last two digit of years and Ww denotes the week in which the capacitor is manufactured) |
| | AAA |
| (4) Capacity /Voltage | --V |
| (5) Negative polarity | |

6.2 标记颜色 Color

套管颜色：透明

标记颜色：灰

Sleeve color: Transparent

Marking color: Gray

File Description	Approval Sheet				
Component P/N	MA	Version	01	Page	9
STANDARD MANUAL					

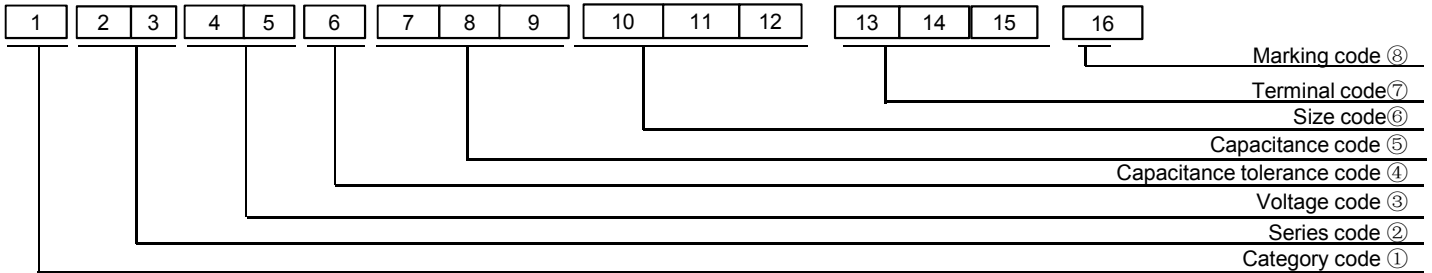
7 物料编码 PART NO SYSTEM

① Category code

Type	Code	
	1th	
Electrolytic Capacitor	E	

② Series code

Series name	Code	
	2th	3th
MA	M	A

③ Voltage code

WV (V)	Code	
	4th	5th
4	0	G
6.3	0	J
10	1	A
16	1	C
25	1	E
35	1	V
40	1	G
50	1	H
63	1	J
80	1	B
100	1	K
160	2	C
180	2	L
200	2	D
220	2	N
250	2	E
315	2	F
350	2	V
380	2	P
400	2	G
420	2	T
450	2	W
500	2	H

④ Capacitance tolerance code

Tol.(%)	Code
-10~+10	K
-20~+20	M
-10~+30	Q
-5~+15	T
-10~+20	V
0~+20	A
-5~+20	C
-10~-20	B
-5~+5	D
0~+10	E
-5~-20	F
-15~+5	N

⑤ Capacitance code

Cap (μF)	Code		
	7th	8th	9th
0.10	R	1	0
0.22	R	2	2
0.33	R	3	3
0.47	R	4	7
0.68	R	6	8
1	0	1	0
2.2	2	R	2
3.3	3	R	3
4.7	4	R	7
6.8	6	R	8
10	1	0	0
22	2	2	0
33	3	3	0
47	4	7	0
68	6	8	0
100	1	0	1
220	2	2	1
330	3	3	1
470	4	7	1
680	6	8	1
1000	1	0	2
2200	2	2	2
3300	3	3	2
4700	4	7	2
6800	6	8	2
10000	1	0	3
22000	2	2	3
33000	3	3	3
68000	6	8	3

⑥ Size code

ΦD	Code
	10th
4	C
5	D
6.3	E
8	F
10	G
11	H
12	J
12.5	W
16	L
18	M

L	Code	
	11th	12th
5.2	5	5
5.7	6	0
6.3	6	6
7.0	7	3
7.7	8	0
8.0	8	3
8.7	9	0
9.5	9	5
10	A	0
10.5	B	0
11	B	5
11.5	C	0
12	C	5
12.5	D	0
13	D	5
13.5	E	0
16	G	5
16.5	H	0
18	J	5
18.5	K	0
19	K	5
19.5	L	0
20	L	5
20.5	M	0
21	M	5
21.5	N	0

⑦ Terminal code

Terminal	Code		
	13th	14th	15th
Bulk packing	O	-	-
Platform rubber & Straight Taping	D	0	0

⑧ Sleeve/Marking code

Sleeve	Code
	16th
PVC	C
PET	T

Marking	Code
	16th
Dark blue	B
Bright Red	R
Sky-blue	S
Pink	Z
Black	H
Purple-blue	V
Red	O

File Description	Approval Sheet				
Component P/N	MA	Version	01	Page	10
STANDARD MANUAL					

8 包装PACKING

按下图包装方式Packing

◆载带尺寸 [mm]

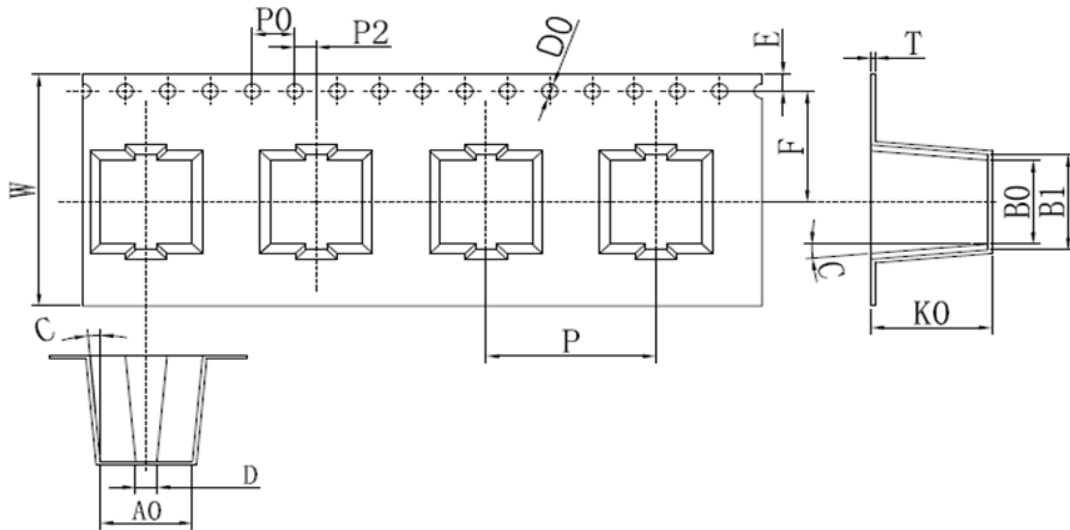

项目		W	A	B	F	P	K0	
		±0.3	±0.2	±0.2	±0.1	±0.1	±0.2	
系列	D80	5*7.7	16	5.7	5.7	7.5	12	8.2
	E80	6.3*7.7	16	7	7	7.5	12	8.2
	E83	6.3*8	16	7	7	7.5	12	8.2
	EB0	6.3*10.5	16	7	7	7.5	12	11
	FB0	8*10.5	24	8.7	8.7	11.5	16	11
	FD0	8*12.5	24	8.7	8.7	11.5	16	13
	FE0	8*13.5	24	8.7	8.7	11.5	16	14
	FG0	8*15.5	24	8.7	8.7	11.5	16	16
	GB0	10*10.5	24	10.7	10.7	11.5	16	11
	GD0	10*12.5	24	10.7	10.7	11.5	16	13
	GE0	10*13.5	24	10.7	10.7	11.5	16	14
	GH0	10*16.5	24	10.7	10.7	11.5	16	17
	WE0	12.5*13.5	32	13.4	13.4	14.2	24	14
	WG5	12.5*16	32	13.4	13.4	14.2	24	16.5
	LH0	16*16.5	44	17.5	17.5	20.2	28	16.8
	LN0	16*21.5	44	17.5	17.5	20.2	28	22.1
	MH0	18*16.5	44	19.5	19.5	20.2	32	17.1
MN0	18*21.5	44	19.5	19.5	20.2	32	22.1	

File Description	Approval Sheet				
Component P/N	MA	Version	01	Page	11
STANDARD MANUAL					

◆包装规格

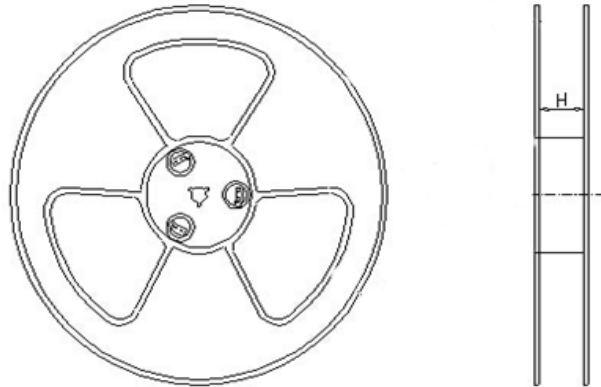

产品尺寸	φ3	φ4	φ5	φ6.3	φ8	φ10	φ12.5	φ16	φ18
H	20	14	14	18	26	26	34	46	46



外箱carton

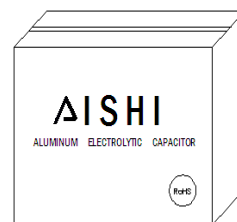

内盒 inner box

File Description	Approval Sheet				
Component P/N	MA	Version	01	Page	12
STANDARD MANUAL					

9 其它说明 OTHER REMARKS

9.1 铝电解电容器使用注意事项

Important Information On The Application Of Aluminium Electrolytic Capacitors

(1) 直流铝电解电容器应按正确的极性使用 DC aluminium electrolytic capacitors are normally polarized

当直流铝电解电容器按反极性接入电路时，电容器会导致电子线路短路，由此产生的电流会引致电容器损坏。若电路中有可能引线施加正电压，请选用无极性产品。

When reverse voltage is applied on DC aluminium electrolytic capacitor the circuit will be short out and the capacitor will be damaged due to abnormal current flows through the capacitor. Please use non-polar types of capacitors the positive voltage is applied on the cathode terminal.

(2) 在额定工作电压以下使用 Use capacitor within rated voltage

当电容器上所施加电压高于额定工作电压时，电容器的漏电流将上升，其电气特性将在短时间内劣化直至损坏。请注意电压峰值勿超出额定工作电压。

When capacitor is used at higher voltage than the rated voltage, leakage current may increase and characteristics may be deteriorated and damaged in a short period. Please take extra caution that the peak voltage should not exceed the rated voltage.

(3) 作快速充放电使用 Sudden charge and discharge

当常规电容器被用作快速充电用途，其使用寿命可能会因为容量下降，温度急剧上升等而缩减。

When aluminium electrolytic capacitors for general purpose-use are employed in rapid charge and discharge its life may be shortened resulted from capacitance decrease, heat rise, etc.

(4) 电容器储存 Storage of the capacitor

① 请保管在室温5~35℃，湿度75%以下的环境。

We recommend the following conditions for storage: Ambient temperature: 5~35°C, Ambient humidity: 75%RH;

a) 产品储存期限: ≤12个月; Storage life: ≤12 months;

b) 库存有效期以套管上印刷的时间开始计算; Expiry date: calculating from the date marked on the sleeve;

c) 请尽量以包装状态保管; Please keep capacitors in the original package;

d) 请避免在以下环境中保管: Avoid storing the capacitors under such circumstances:

※ 溅水、高温高湿及结露的环境。With water and oil or damp & dewing location

※ 溅油、或者充满气体油成分的环境。With gas and oil.

※ 充满酸性有毒气体（硫化氢，亚硫酸，亚硝酸，氯，溴，溴化甲烷等）的环境。

With toxic gases such as hydrogen sulfide, sulfurous acid, nitrous acid, chlorine, bromine and methane

※ 阳光、臭氧、紫外线及放射线照射的环境。With direct sunlight, Ozone, ultraviolet rays or radiation.

② 当电容器长期储存后，漏电流会升高，温度愈高，漏电流上升愈快，因此应注意储存环境。在电容器上施加电压后，漏电流值降，如铝电解电容器的漏电流上升对电路有不良影响，请在使用前充电处理。

Leakage current tends to increase when capacitors have been stored for long period of time. The higher storage Temp. rise, the higher leakage current increase. Please take caution when selecting the storage location. The leakage current will decrease gradually as voltage is applied to the capacitor. The capacitor is subjected to aging before using where increased leakage may cause problems in the circuit.

(5) 施加纹波电流应小于额定值 Use capacitor within rated ripple current

施加纹波电流超过额定值后，会导致电容器体过热，容量下降，寿命缩短。电容器上标注了额定电压，请将和直流电压叠加的电压的峰值控制在额定工作电压以下。

If excessive ripple current is applied on the capacitor, excessive heat will be generated inside, the capacitance be reduced capacitor's life shall be shortened. Rated voltage has been marked on the capacitor; therefore, the peak value of the ripple voltage should be less than the rated voltage.

File Description	Approval Sheet				
Component P/N	MA	Version	01	Page	13
STANDARD MANUAL					

(6) 使用环境温度 Ambient temperature

铝电解电容器使用寿命会受到环境温度的影响。据科学统计，使用环境温度下降10°C其使用寿命增加1倍。

Life of aluminium electrolytic capacitor is affected by the ambient temperature. It is generally known that the life doubles for 10°C decrease in temperature.

(7) 引出线强度 Tensile strength of lead wire

当拉力施加到电容器引出线，该拉力将作用于电容器内部，这可能导致电容器内部短路，开路或漏电流上升。在电容器焊装到电路板，请勿强烈摇动电容器。

When a strong force is applied to the lead wires or terminals, stress is put on the internal connections, which may result in short circuit, open circuit or leakage current increase. Therefore it is not advisable to bend or handle a capacitor after it has been to the PC board.

(8) 焊接过程耐热性 Heat resistance at the soldering process

当电容器装至电路板浸焊或波峰焊时，其塑料套管可能因焊接时间过长、温度过高而发生破裂或二次收缩。

During soldering process, secondary shrinkage or sleeve crack may occur when soldering temperature is too high or soldering time is too long.

(9) 电路板的安装孔孔距及安装位置 Hole pitch and position of PC board

电路板安装孔的设计应与产品说明书的引线脚距相一致，如果将电容器强行插入孔距不配套的电路板，那么会有应力作用于引出线，这可能导致短路或漏电流上升。

When designing a PC board, its hole pitch should be designed to coincide with the lead pitch(lead spacing) of the specified in the catalog or specifications. When a capacitor is forcibly inserted into an unmatched hole pitch, a will put on the leads and which could result in a short circuit or increased leakage current.

(10) 关于焊接以后的清洗 Cleaning after soldering

①电容器不能用卤化有机物系列的清洗剂进行清洗。如果必须清洗，请使用能够保证电容器质量的清洗剂。

The aluminium electrolytic capacitors should be free of halogenated solvents during board cleaning after soldering. Use solvent proof capacitors when halogenated solvents are used.

②对于能够保证电容器质量的清洗剂，清洗后请不要在清洗溶液或者密封容器中保管。清洗后的电容器请和电路板一起在热风下燥10分钟以上，热风的温度不可高于电容器规定上限温度。

After cleaned with the solvent which can guarantee the quality of capacitors, the capacitors should not be kept in solvent environments of non-ventilated places. Let the capacitors after cleaning dry with hot blast fully above 10 mins and the temperature of hot blast should not be over than specified upper limit of that of capacitors.

(11) 关于固定剂以及镀层（涂层剂） Adhesives、fixative and coating materials(coating agent)

①请不要使用含有卤化有机物系列的固定剂及镀层（涂层剂）。

Do not use halogenated adhesives and coating materials to fix aluminium electrolytic capacitors.

②请不要让固定剂及镀层（涂层剂）将电容器封口部位（端子一侧）全部封住。

Do not cover up all the sealing area of capacitors with adhesives、fixative or coating materials(coating agent),make coverage only partial.

9.2符合 RoHS RoHS Compliance

符合欧盟RoHS的最新标准，若客户有特殊要求，按照双方签订的相关协议为准。

Completely in accordance with the latest standard of RoHS or relevant agreements reached by both parts if customer has special requirements.

File Description	Approval Sheet				
Component P/N	MA	Version	01	Page	14
STANDARD MANUAL					