

Surge arrester

2-Electrode arrester

Series/Type: DG401A

Customer:

Version/Date: Issue 02/2015-9-9

Surge arrester

2-Electrode arrester

DG401A

Features	Applications
<ul style="list-style-type: none"> ● Extremely small size ● Extremely fast response time ● Excellent SMD handling ● Stable performance over life ● Very low capacitance ● High insulation resistance ● RoHS-compatible ● UL-identification, No:E311500 	<ul style="list-style-type: none"> ● Splitter ● PCI Cards ● Morden ● Line cards

Electrical specifications

DC breakdown voltage ^{2) 3)} —Circuit current less than 2mA	400 ±20	V %
Impulse breakdown voltage ¹⁾ at 1kv/us -Typical values of distribution	≤900	V
Insulation resistance at DC 100V	≥1	GΩ
Capacitance at 1MHz ²⁾	≤1	Pf
Service life ²⁾		
10 operations 8/20us	1	KA
10 operations 50Hz	1	A
Weight	~1	g
Storage and operations temperature	-40...+90	°C
Climatic category (GB/T 9043, IEC61643-1)	40/90/21	
Marking,Red positive	Without	



Tel: +86-510-81707285

Fax: +86-510-81707277

www.jsdgame.com

DC breakdown voltage

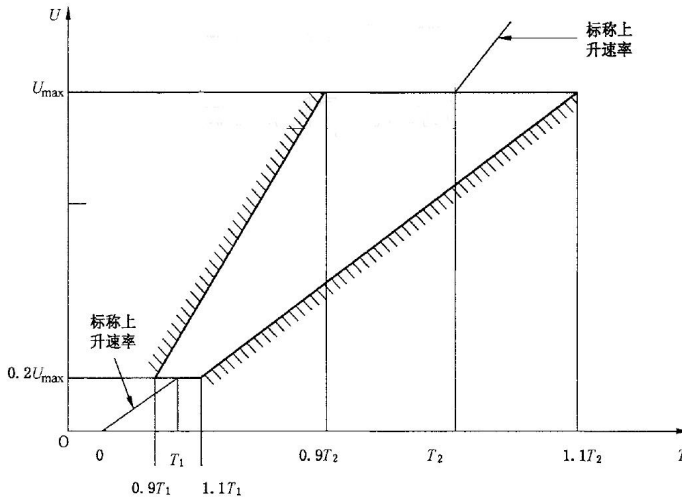

8/20us, Test wave

$$T1=1.25T=8\mu s \pm 20\%$$

$$T2=20\mu s \pm 20\%$$

10/700us, Test Wave

$$T1=1.67T=10\mu s \pm 20\%$$

$$T2=700\mu s \pm 20\%$$

10/1000us, Test Wave

$$T1=1.67T=10\mu s \pm 20\%$$

$$T2=1000\mu s \pm 20\%$$

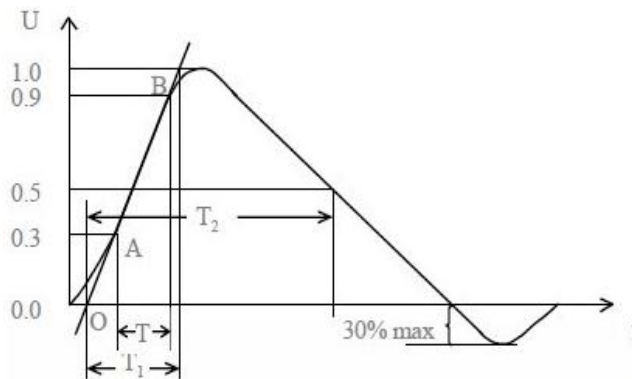

Recommended wave soldering profile

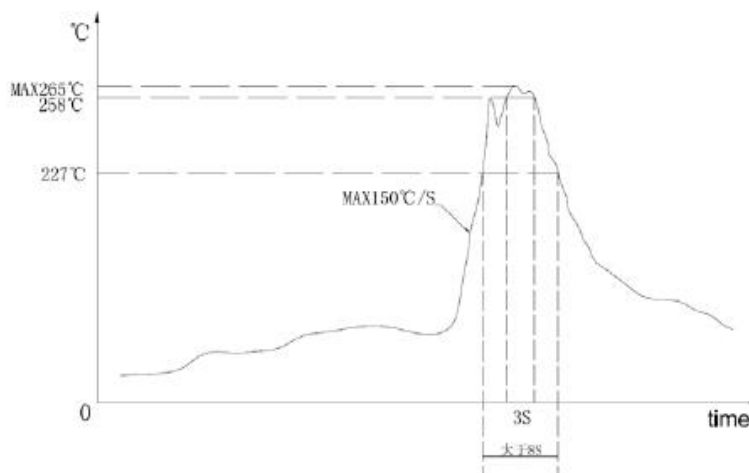

- 1) Sampling size in accordance to AQL(C=0)
- 2) DC spark-over voltage $\pm 30\%$ after load
- 3) Tests according to ITU-T Rec. K. 12 and IEC61643-1

Dimensions

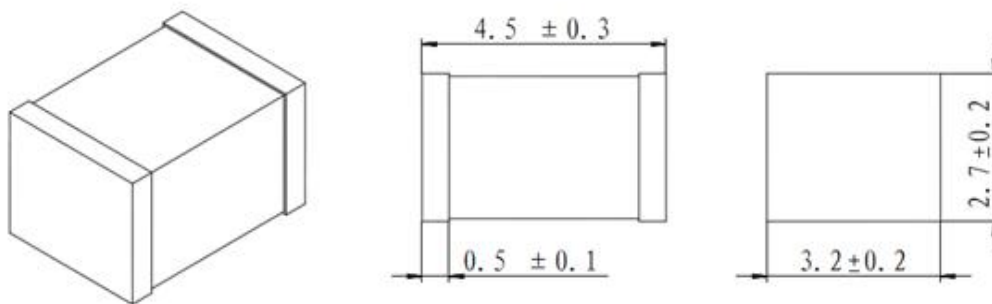

Wire Tin-plated

Packaging

One reel with 3000pcs

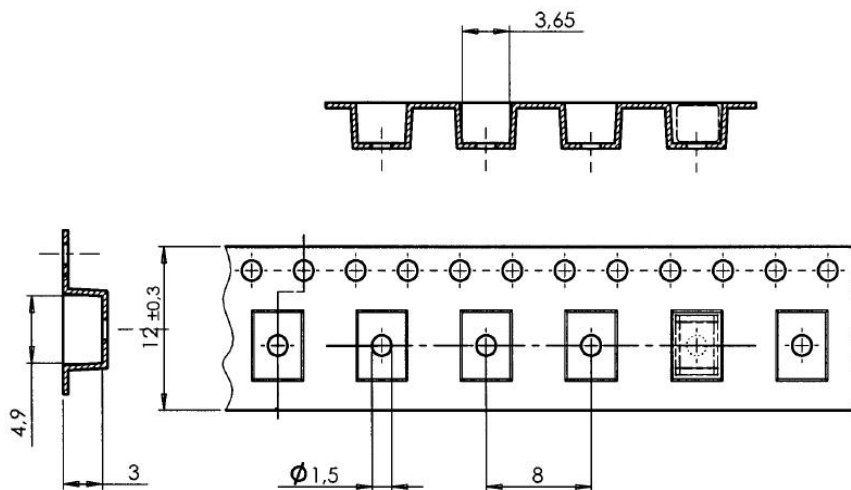

Cautions and warnings

- Surge arresters must not be operated directly in power supply networks
- Surge arresters may become hot in case of longer periods of current stress (danger of burning).
- If the contacts of the surge arrester are defective, current stress can lead to the formation of sparks and loud noises.
- Surge arresters may be used only within their specified values. In case of overload, the head contacts may fail or the component may be destroyed.
- Damaged surge arresters must not be re-used.