



洲光源
CHAULIGHT

产品规格书 SPECIFICATION

客户名称: _____
Customer Name
产品类型: _____ 反射式光电开关
Product Name
产品型号: _____ ZSOS-R0705-B08
Part No.

<input type="checkbox"/> 技术参考 Technical Reference		<input type="checkbox"/> 样品 Sample		<input type="checkbox"/> 量产供货 Mass Product	
客户审核 (加盖公章) Client approval (Stamp)			洲光源审核 Chaulight approval		
核准Approval	确认Checked	核准Approval	确认Checked	制作Edited	
		郝三强	王乐	付世雄	
<input type="checkbox"/> 接收 Qualified			<input type="checkbox"/> 不接收 Disqualified		日期 Date: 2020-12-31

联系电话(Tel): 13828819291

E-mail: tony@zgy-led.com

地址(Add): 深圳市宝安区航城街道航空路36号华盛泰科技大厦D栋502

No.502, Building D, Huashengtai Science and Technology Building, No. 36, Hangcheng Street, Bao'an District, Shenzhen.

本规格书仅用于双方交流用需经双方签订后方可生效, 自签订后有效期为两年, 期满后需以书面形式续签。最终解释权为洲光源所有。

This product specification is only used for technical communication. Only after the signature or seal, the specifications have the force of law. since the signing of the validity period of two years, after the expiration of the written renewal. The final interpretation right is owned by the CHAULIGHT.

广东洲光源红外半导体有限公司
Guangdong Chaulight Infrared Semiconductor Co., Ltd.

ZSOS-R0705-B08 由红外发射二极管和NPN 硅光晶体管组成，它们并排封装在黑色热塑性外壳中的汇聚光轴上。光电晶体管只接收来自 IR 的辐射。这是正常情况。但当物体在中间时，光电晶体管不能接收辐射。有关更多组件信息，请参阅 IR 和 PT。

The ZSOS-R0705-B08 consist of an infrared emitting diode and an NPN silicon phototransistor, encased side-by-side on converging optical axis in a black thermoplastic housing. The phototransistor receives radiation from the IR only. This is the normal situation. But when an object is in between, phototransistor could not receives the radiation. For additional component information, please refer to IR and PT.



特性 Feature

--可靠性高、辐射强度高、低电压驱动

High reliability、High radiant intensity、Low forward voltage、

--感应速度快、感光度强

Fast response time、High photo sensitivity

--截止感应波长 940nm

Cut-off visible wavelength $\lambda_p=940\text{nm}$

--无铅材料、RoHS 认证

Pb.Free、RoHS compliant version

应用 Application

--打印机、非接触开关

Printer、Non-contact Switching

--智能电子产品

Intelligent Electronic Products

--工业机械设备

Industrial Intelligent Equipment

--安防防护应用

Safety Application Products

最大额定值 Absolute Maximum Ratings

测试项目	Parameter (Ta=25°C)	符合Symbol	范围 Ratings	单位 Unit
输入端发射极 Input Emitter	功率Power Dissipation *1	Pd	75	mW
	反向电压Reverse Voltage	V _R	5	V
	持续正向电流Forward Current	I _F	50	mA
	脉冲正向电流Peak Forward Current *2	I _{FP}	1	A
输出端接收极 Output Detector	功率Power Dissipation *1	Pd	75	mW
	集电极-发射极电压Collector-Emitter Voltage	V _{CEO}	30	V
	发射极-集电极电压Emitter-Collector Voltage	V _{ECO}	5	V
	集电极电流Collector Current	I _{C(ON)}	20	mA
工作温度Operating Temperature	Topr	-25~+85	°C	
储存温度Storage Temperature	Tstg	-40~+85	°C	
焊接温度Lead Soldering Temperature*3	Tsol	260	°C	

*1、在 25 摄氏度的环境中测试 below 25 Free Air Temperature

*2、脉宽少于等于 100us, 占空比 1% Pulse width ≤ 100μs, Duty cycle= 1%

*3、离胶体 2mm 以上焊接 5s 内 2mm form body for 5 seconds

光电特性 Electro-Optical Characteristics

电性参数 (温度=25°C)		符号	条件	最小值	典型值	最大值	单位
Parameter (Ta=25°C)		Symbol	Condition	Min.	Typ.	Max.	Units
输入端 Input	正向电压Forward Voltage	V _F	I _F =20mA	--	1.2	1.5	V
			I _F =100mA*2	--	1.4	1.85	
			I _F =1A *2	--	2.6	4.0	
	峰值波长Peak Wavelength	λ _p	I _F =20mA	--	940	--	nm
	反向电流Reverse Current	I _R	V _R =5V	--	--	10	μA
输出端 Output	暗电流 Dark Current	I _{CEO}	Ee=0mW/cm ² V _{CE} =20V	--	--	100	nA
	集电极-发射极的工作电压 C-E Saturation Voltage	V _{CE(SAT)}	I _C =2mA Ee=1mW/cm ²	--	--	0.4	V
转换特性 Transfer Characteristics	上升时间Rise Time	t _r	V _{CE} =5V	--	25	--	μS
	下降时间Fall Time	t _f	I _C =1mA R _L =1000Ω	--	25	--	
	光电流 Collector Current	I _{C(ON)}	V _{CE} =2V I _F =10mA	0.6	--	--	mA

*2、脉宽少于等于 100us, 占空比 1% Pulse width ≤ 100μs, Duty cycle= 1%

等级档位 Rank

档位 Bin	符号 Symbol	条件 Condition	最小值 Min.	最大值 Max.	单位 Unit
L	IC(on)	IF=10mA, Vce=2V	0.6	0.9	mA
K	IC(on)	IF=10mA, Vce=2V	0.8	1.8	mA
J	IC(on)	IF=10mA, Vce=2V	1.6	3.6	mA
H	IC(on)	IF=10mA, Vce=2V	3.2	--	mA

备注Notes:

--正向电压的测量公差是 $\pm 0.1V$ Measurement Uncertainty of Forward Voltage: $\pm 0.1V$ --发光强度的测量公差是 $\pm 10\%$ Measurement Uncertainty of Luminous Intensity: $\pm 10\%$ --峰值波长的测量公差是 $\pm 1.0nm$ Measurement Uncertainty of Dominant Wavelength $\pm 1.0nm$

产品尺寸 Package Dimension

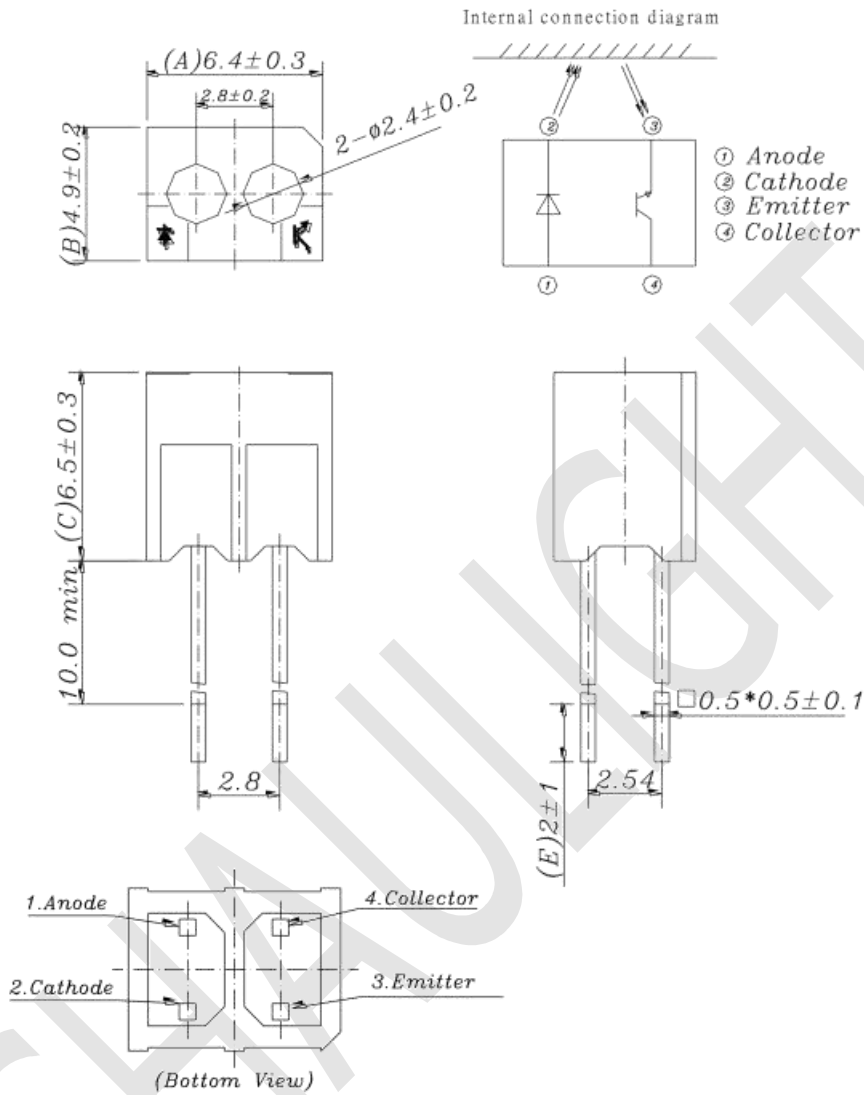

备注Notes:

--所有尺寸为毫米标识

All dimensions are in millimeters

--未标识尺寸正负公差为 0.3mm

Tolerances unless dimensions $\pm 0.3\text{mm}$

发射管特性曲线图 Typical Electro-Optical Characteristics Curves-IR

正向电流与环境温度的关系

Forward Current vs. Ambient Temperature

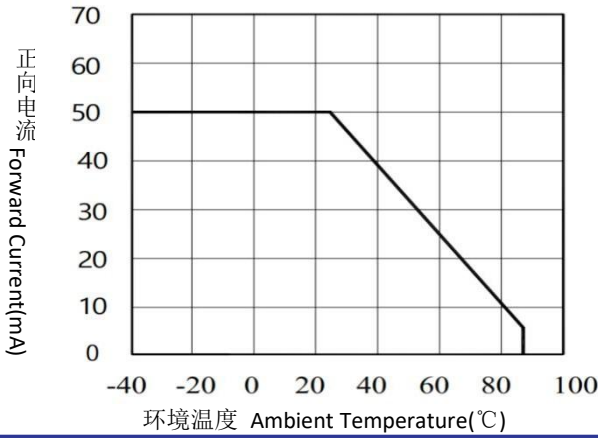

正向电流与正向电压的关系

Forward Current vs. Forward Voltage

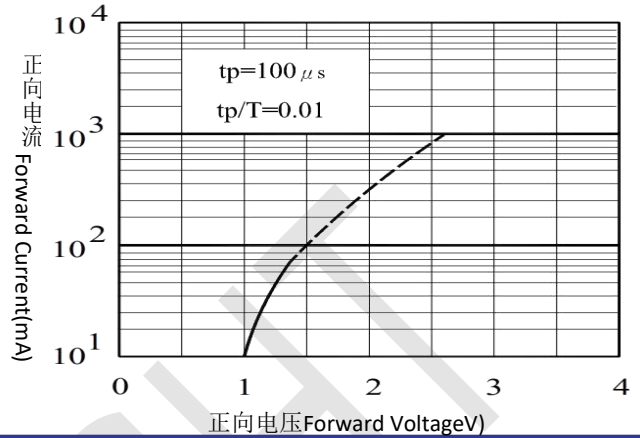

辐射强度与正向电流的关系

Radiant Intensity vs. Forward Current

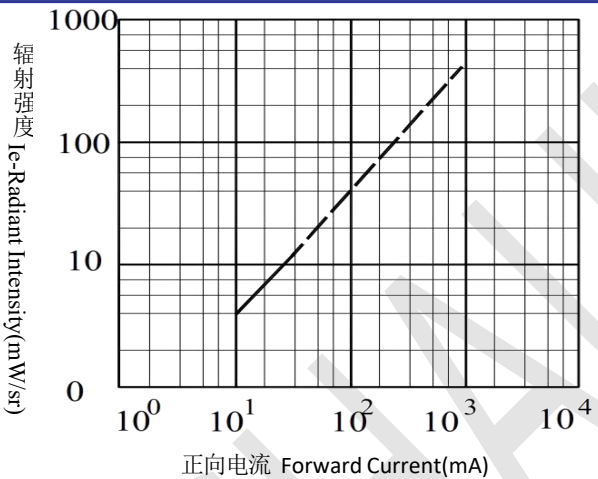

波长曲线图

Spectral Distribution

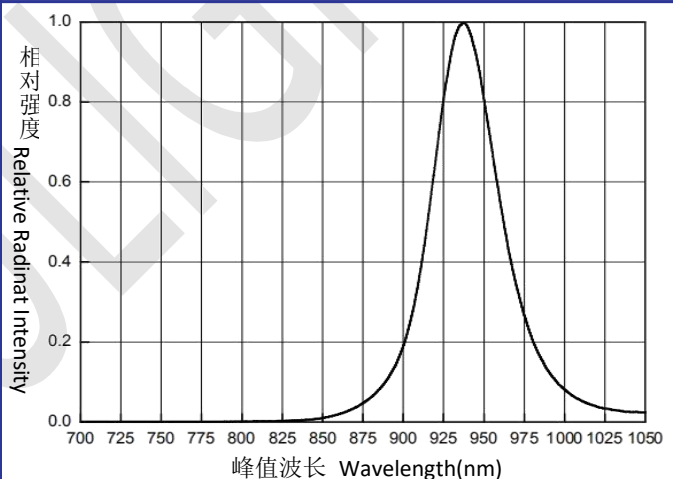

峰值波长与环境温度的关系

Peak Emission Wavelength vs. Ambient Temperature

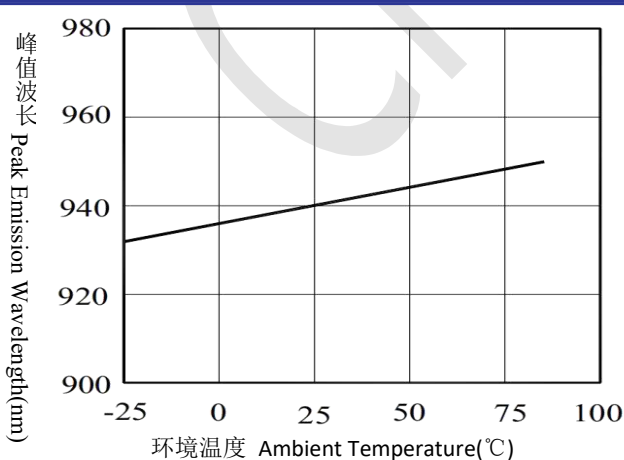

相对辐射强度与角位移的关系

Relative Radiant Intensity vs. Angular Displacement

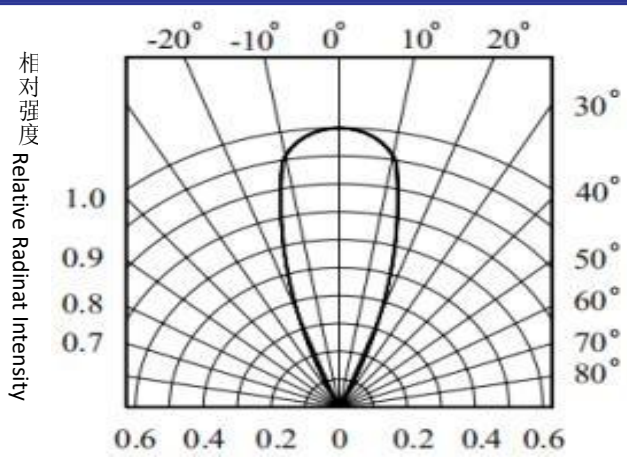

接收管特性曲线图 Typical Electro-Optical Characteristics Curves-PT

集电极功率与环境温度的关系

Collector Power Dissipation vs. Ambient Temperature

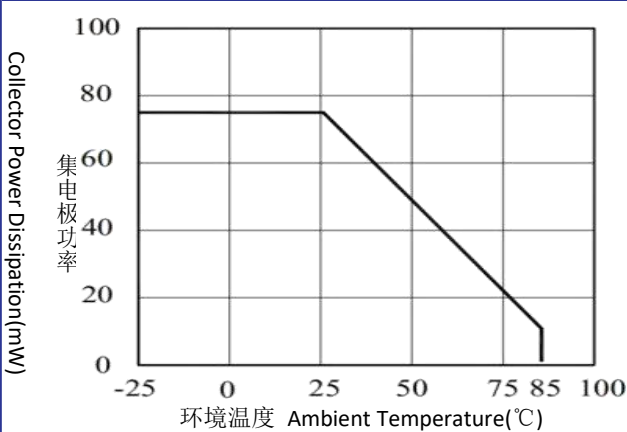

相对集电极电流与环境温度的关系

Relative Collector Current vs. Ambient Temperature

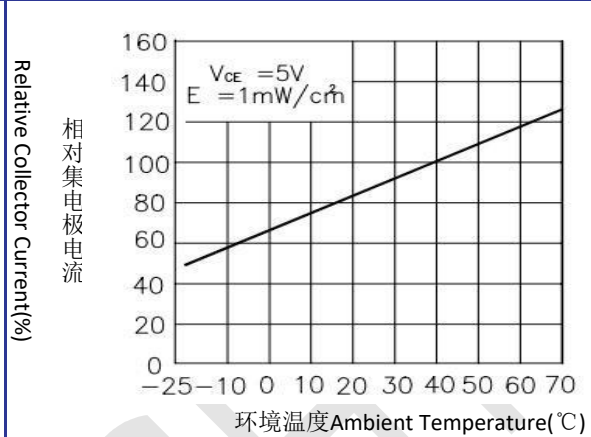

集电极暗电流与环境温度的关系

Collector Dark Current vs. Ambient Temperature

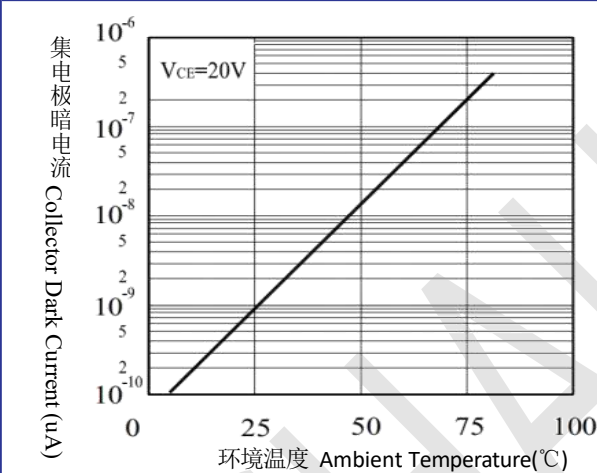

感应波长曲线图

Spectral Sensitivity

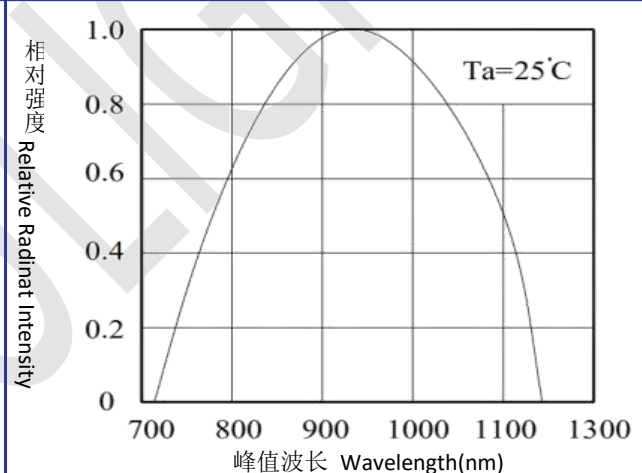

集电极电流与辐射强度的关系

Collector Current vs. Irradiance

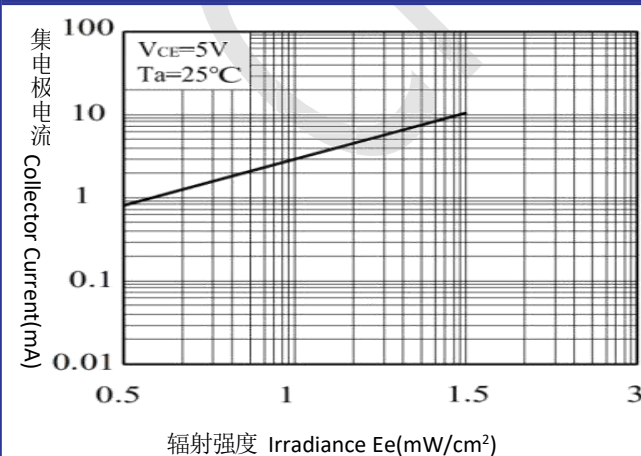

集电极电流与集电极-发射极电压的关系

Collector Current vs. Collector-Emitter Voltage

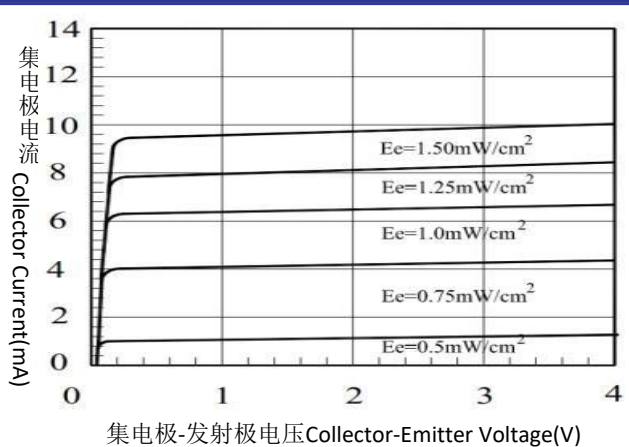

▶ 光电开关特性曲线图 Typical Electro-Optical Characteristics Curves-ITR

光电流与感应距离之间的关系 Relative Collector Current vs Distance Between Sensor

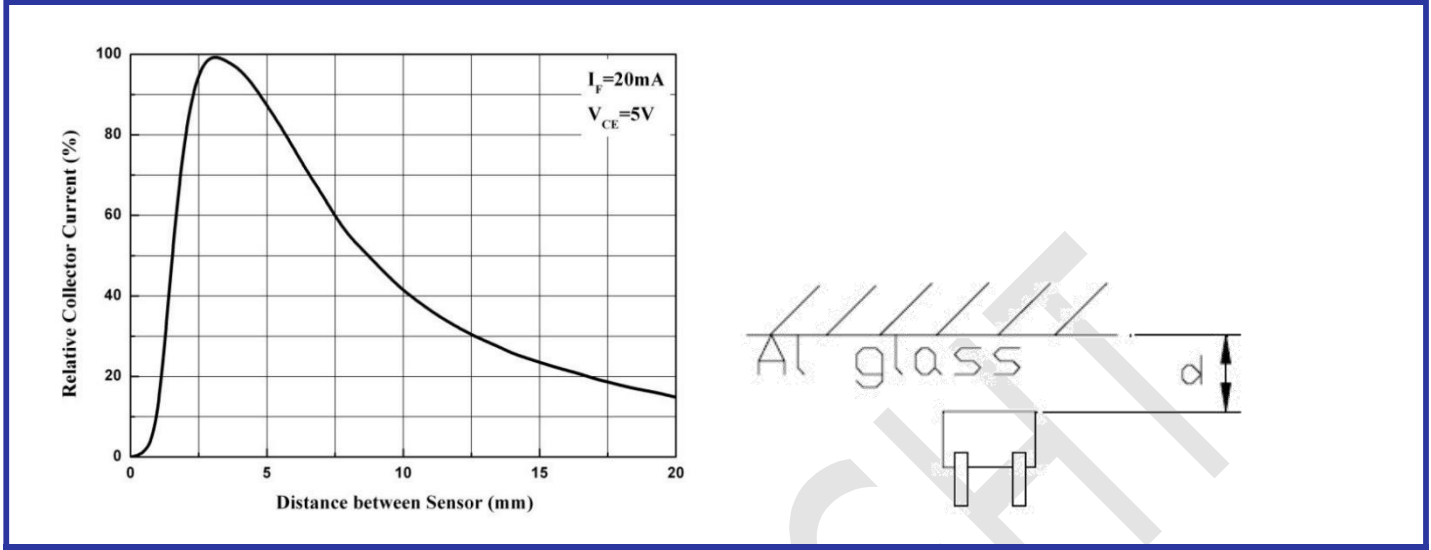

▶ 包装规格 Packing Specification

防静电袋 Anti-electrostatic bag

内包装盒 Inner Carton

外箱 Outside Carton

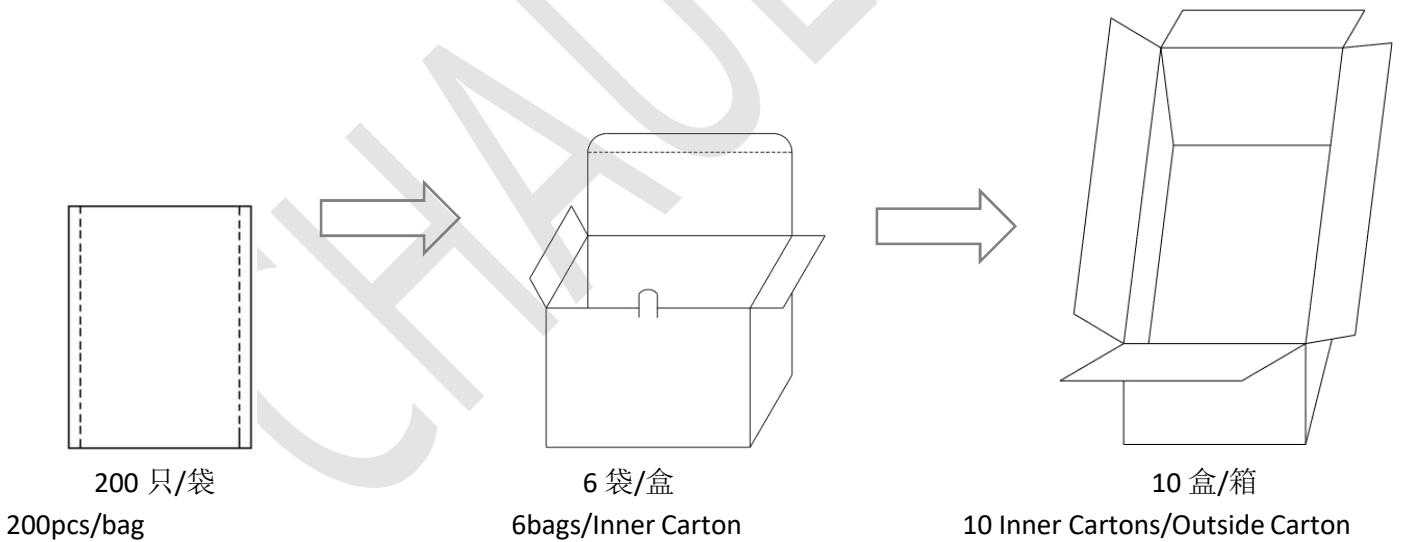

► 注意事项 Note

--其他 Other

- 1、以上规格可更改，恕不另行通知。 洲光源将为上述规格的材料变更保留权力 Above specification may be changed without notice. CHAU LIGHT will reserve authority on material change for above specification.
- 2、当使用此产品时，请观察这些规格表中概述的绝对最大额定值和使用说明。洲光源不承担任何损坏结果的责任从不符合绝对最大额定值的产品的使用和这些规格表中包含的说明 When using this product, please observe the absolute maximum ratings and the instruction for using outlined in these specification sheets. CHAU LIGHT assumes no responsibility for any damage resulting from use of the product which does not comply with the absolute maximum ratings and the instructions included in these specification sheets.
- 3、此规格书版权属广东洲光源红外半导体有限公司。未经允许不得转载或复印。These specification sheets include materials protected under copyright of CHAU LIGHT corporation. Please don't reproduce or cause anyone to reproduce them without CHAU LIGHT's consent.

► 更改记录表 Engineering Change Notice-Record

版本 Edition	更改日期 Date	主要更改内容 Main Content	拟制 Prepared	确认 Checked
1.1	2020-12-31	新版本发布New Edition	王乐	郝三强