

SMAF

FEATURES

- Metal silicon junction, majority carrier conduction
- For surface mounted applications
- Low power loss, high efficiency
- High forward surge current capability
- For use in low voltage, high frequency inverters, free wheeling, and polarity protection applications

MECHANICAL DATA

- Case: SMAF
- Terminals: Solderable per MIL-STD-750, Method 2026
- Approx. Weight: 27mg / 0.00095oz

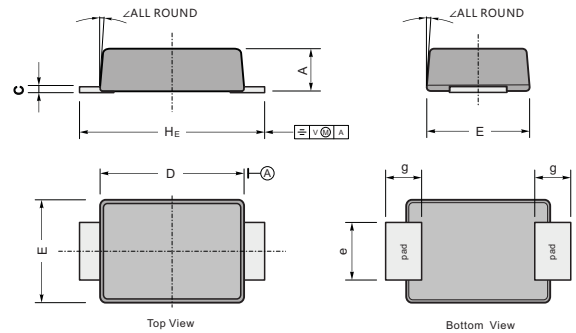

UNIT		A	C	D	E	e	g	H _E	∠
mm	max	1.2	0.20	3.7	2.7	1.6	1.2	4.9	7°
	min	0.9	0.12	3.3	2.4	1.3	0.8	4.4	
mil	max	47	7.9	146	106	63	47	193	7°
	min	35	4.7	130	94	51	31	173	

Absolute Maximum Ratings and Electrical characteristics

Ratings at 25 °C ambient temperature unless otherwise specified. Single phase, half wave, 60Hz resistive or inductive load, for capacitive load, derate by 20 %

Parameter	Symbols	SS12	SS14	SS16	SS18	SS110	SS112	SS115	SS120	Units	
Maximum Repetitive Peak Reverse Voltage	V _{RRM}	20	40	60	80	100	120	150	200	V	
Maximum RMS voltage	V _{RMS}	14	28	42	56	70	84	105	140	V	
Maximum DC Blocking Voltage	V _{DC}	20	40	60	80	100	120	150	200	V	
Maximum Average Forward Rectified Current	I _{F(AV)}	1.0								A	
Peak Forward Surge Current, 8.3ms Single Half Sine-wave Superimposed on Rated Load (JEDEC method)	I _{FSM}	30								A	
Max Instantaneous Forward Voltage at 1 A	V _F	0.55	0.70	0.85	0.90					V	
Maximum DC Reverse Current T _a = 25°C at Rated DC Reverse Voltage T _a = 100°C	I _R	0.3 10			0.2 5		0.1 2				mA
Typical Junction Capacitance ⁽¹⁾	C _j	110	80							pF	
Typical Thermal Resistance ⁽²⁾	R _{θJA}	95								°C/W	
Operating Junction Temperature Range	T _j	-55 ~ +125								°C	
Storage Temperature Range	T _{stg}	-55 ~ +150								°C	

(1) Measured at 1 MHz and applied reverse voltage of 4 V D.C

(2) P.C.B. mounted with 2.0" X 2.0" (5 X 5 cm) copper pad areas.

Fig.1 Forward Current Derating Curve

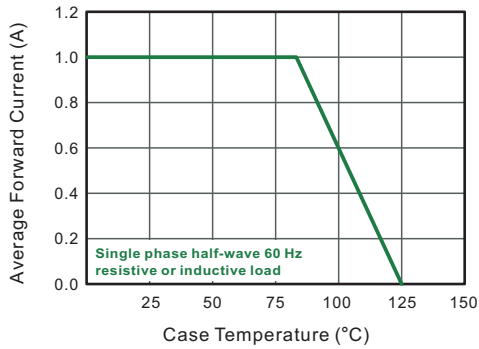

Fig.2 Typical Reverse Characteristics

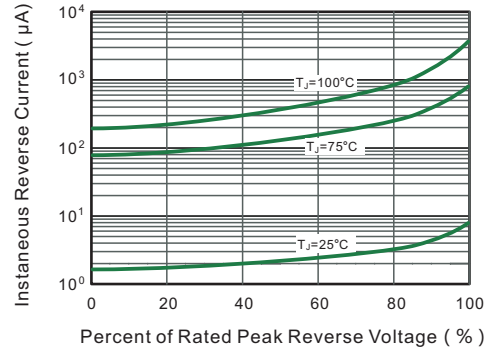

Fig.3 Typical Forward Characteristic

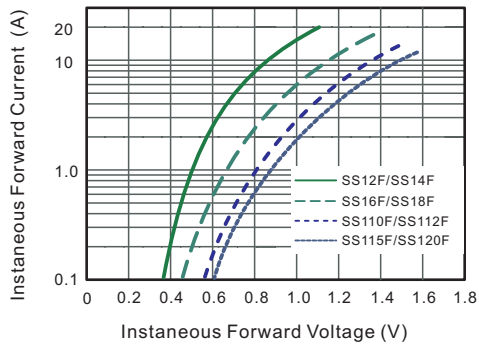

Fig.4 Typical Junction Capacitance

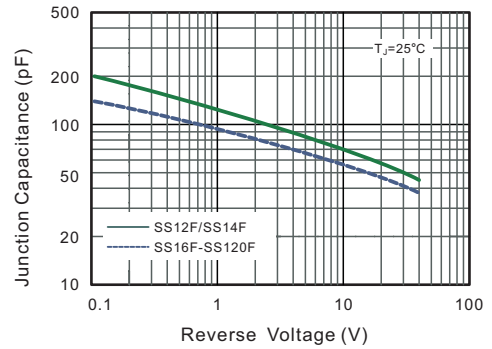

Fig.5 Maximum Non-Repetitive Peak Forward Surge Current

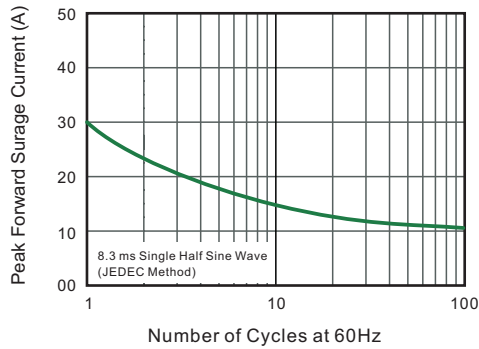
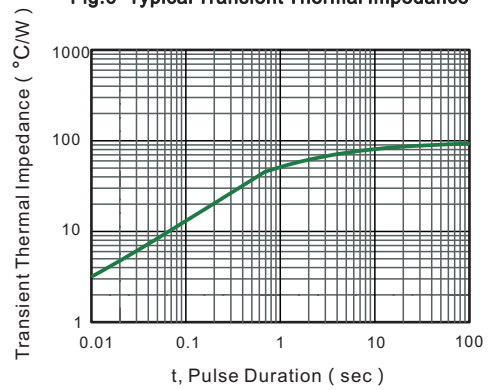

Fig.6- Typical Transient Thermal Impedance



The recommended mounting pad size

