

WS7916S

CMOS High Gain GPS LNA

<http://www.sh-willsemi.com>

Descriptions

The WS7916S is a low noise amplifier (LNA) for GNSS receiver applications (including GPS, GLONASS, BeiDou and Galileo), available in a small 6-pin DFN package. The WS7916S requires only one external inductor for input matching.

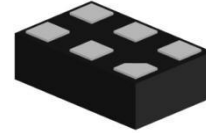

DFN1510-6L (Bottom view)

The WS7916S is designed to achieve low power dissipation and good performance.

Features

- Operating frequency: 1550 MHz to 1615 MHz
- Noise figure = 0.65 dB
- Gain = 16.5 dB
- Input 1 dB compression point = -5.5 dBm
- Out-of-band input IP3 = +8.0 dBm
- Supply voltage: 1.8 V to 3.1 V
- Integrated supply decoupling capacitor
- Digital On/Off switch (1.2 V logic high level)
- Supply current: 6.9 mA
- Power-down mode leakage current < 3μA
- One external matching inductor required
- RF output internally matched to 50 Ohm
- ESD protection: HBM > 2.0kV for all pins
- Package: 6-pin DFN, 1.5 x 1.0 x 0.55 mm³
- Process: CMOS

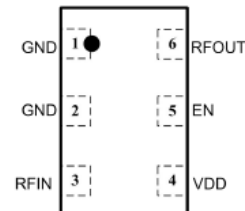

Pin configuration (Top view)

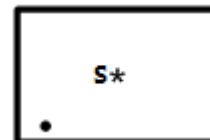

S = Device code
* = Month code (A~Z)

Marking (Top view)

Applications

- Cell phones
- Tablets
- Other RF front-end modules

Order information

Device	Package	Shipping
WS7916S-6/TR	DFN1510-6L	3000/Reel&Tape

Pinning Information

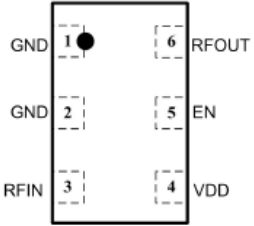
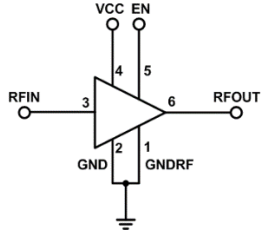
Pin	Description	Transparent top view	Symbol view
1	GNDRF		
2	GND		
3	RFIN		
4	VDD		
5	EN		
6	RFOUT		

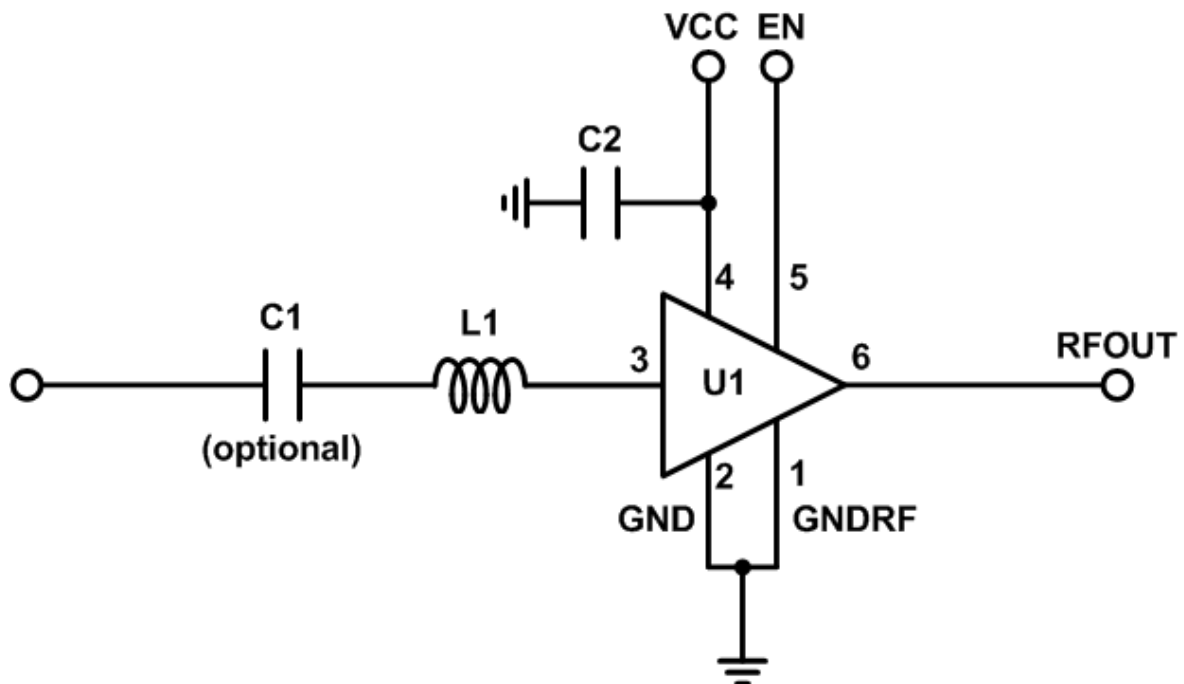
Application Information

Symbol	Description	Footprint	Value	Supplier	Comment
U1	WS7916S	1.5x1.0x0.55 mm ³	N/A	Will-Semi	DUT
C1	Capacitor	0402	1 nF	Various	DC blocking
C2	Capacitor	0402	1 nF	Various	Supply decoupling
L1	Inductor	0402	10 nH	Murata LQW15	Input matching

Quick Reference Data

Freq = 1575.42 MHz; $V_{CC} = 2.8\text{ V}$; $V_{EN} > 1.2\text{ V}$; Temp = 25°C; input matched to 50 Ω with a 10 nH inductor. The condition is applied unless otherwise specified.

Symbol	Parameter	Condition	Min	Typ	Max	Unit
V_{CC}	Supply voltage		1.8	2.8	3.1	V
I_{CC}	Supply current			6.9		mA
G_p	Power gain			16.5		dB
NF	Noise figure			0.65		dB
IP_{1dB}	Input power at 1 dB gain compression			-5.5		dBm
IIP_3	Input third-order intercept point			+8.0		dBm

Recommended Operating Conditions

Symbol	Parameter	Condition	Min	Typ	Max	Unit
V_{CC}	Supply voltage		1.8		3.1	V
Temp	Ambient temperature		-40	+25	+85	°C
V_{EN}	Input voltage on pin 6 (EN)	OFF state		0	0.4	V
		ON state	1.2	V_{CC}		V

Absolute Maximum Ratings

Maximum ratings are absolute ratings, exceeding only one of these values may cause irreversible damage to the integrated circuit.

Symbol	Parameter	Condition	Min	Max	Unit
V_{CC}	Supply voltage		-0.3	3.1	V
V_{EN}	Input voltage on pin EN		-0.3	3.1	V
V_{RFIN}	Input voltage on pin RFIN		-0.3	3.1	V
V_{RFOUT}	Input voltage on pin RFOUT		-0.3	3.1	V
P_{in}	RF input power			0	dBm
T_{STG}	Storage temperature		-65	+150	°C
T_J	Junction temperature			150	°C
V_{ESD}	ESD capability all pins	Human Body Model (HBM)		± 2000	V

Electrical Characteristics

1550 MHz \leq f \leq 1615 MHz; V_{CC} = 2.8 V; V_{EN} > 1.2 V; Temp = 25°C; input matched to 50 Ω with a 10 nH inductor; The condition is applied unless otherwise specified.

Symbol	Parameter	Conditions	Min	Typ	Max	Unit
I _{CC}	Supply current	On state		6.9		mA
		Off state			3	μ A
G _p	Power gain	f = 1575 MHz		16.5		dB
RL _{in}	Input return loss	f = 1575 MHz		8		dB
RL _{out}	Output return loss	f = 1575 MHz		13.0		dB
ISL	Reverse isolation	f = 1575 MHz		24.0		dB
NF	Noise figure ^[1]	f = 1575 MHz		0.65		dB
IP _{1dB}	Input power at 1 dB gain compression	f = 1575 MHz		-5.5		dBm
O-IIP ₃	Out-of-band Input third-order intercept point ^[2]			+8.0		dBm
K	Rollett stability factor ^[3]		1			
t _{on}	Turn-on time			5		μ s
t _{off}	Turn-off time			5		μ s

1550 MHz \leq f \leq 1615 MHz; V_{CC} = 1.8 V; V_{EN} > 1.2 V; Temp = 25°C; input matched to 50 Ω with a 10 nH inductor; The condition is applied unless otherwise specified.

Symbol	Parameter	Conditions	Min	Typ	Max	Unit
I _{CC}	Supply current	On state		5		mA
		Off state			3	μ A
G _p	Power gain	f = 1575 MHz		15.5		dB
RL _{in}	Input return loss	f = 1575 MHz		7.5		dB
RL _{out}	Output return loss	f = 1575 MHz		13.0		dB
ISL	Reverse isolation	f = 1575 MHz		24.0		dB
NF	Noise figure ^[1]	f = 1575 MHz		0.7		dB
IP _{1dB}	Input power at 1 dB gain compression	f = 1575 MHz		-9.0		dBm
O-IIP ₃	Out-of-band Input third-order intercept point ^[2]			+8.0		dBm
K	Rollett stability factor ^[3]		1			
t _{on}	Turn-on time			5		μ s
t _{off}	Turn-off time			5		μ s

[1] Including PCB loss (PCB loss: 0.05-0.1 dB @ 1.575 GHz)

[2] f₁ = 1713 MHz, f₂ = 1851 MHz, P_{in} = -20 dBm

[3] 10M~20GHz

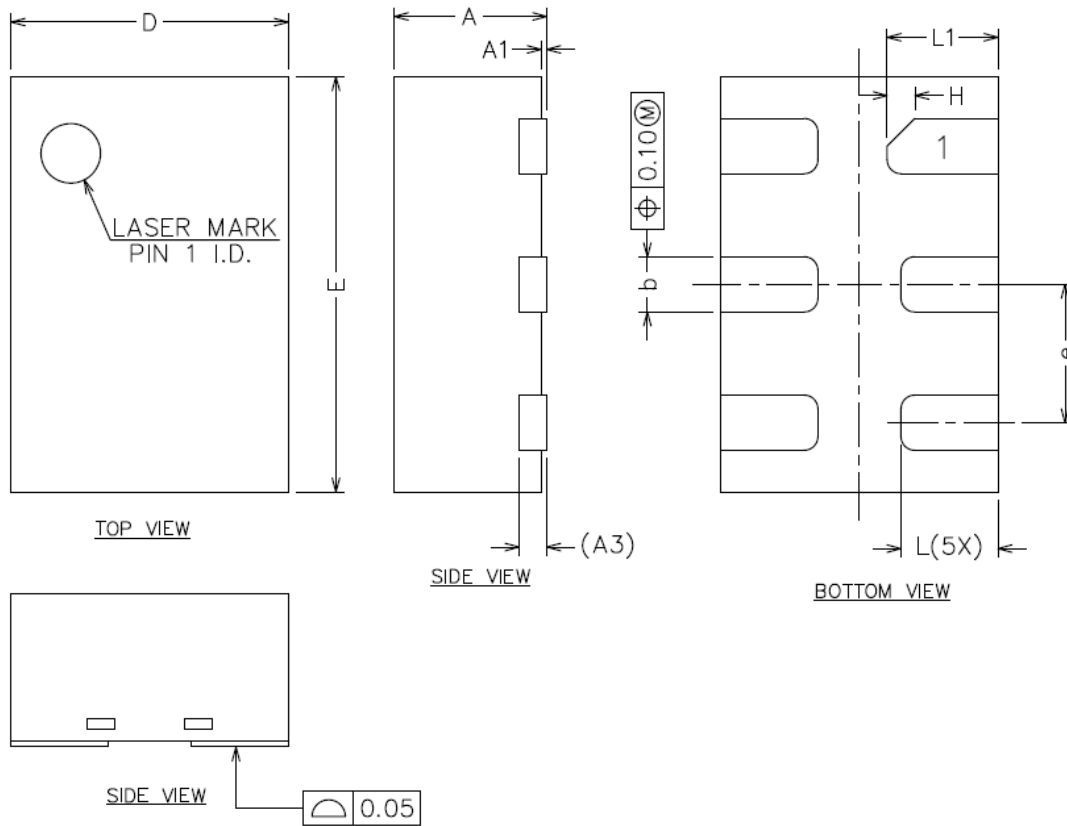
Package Outline Dimensions
DFN1510-6L

Symbol	Dimensions In Millimeters		
	Min.	Typ.	Max.
A	0.50	N/A	0.60
A1	0.00	0.02	0.05
A3	0.10REF		
b	0.15	0.20	0.25
D	0.90	1.00	1.10
E	1.40	1.50	1.60
e	0.40	0.50	0.60
H	0.10REF		
L	0.30	0.35	0.40
L1	0.35	0.40	0.45

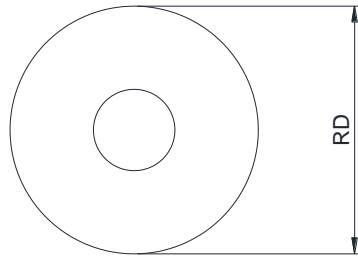
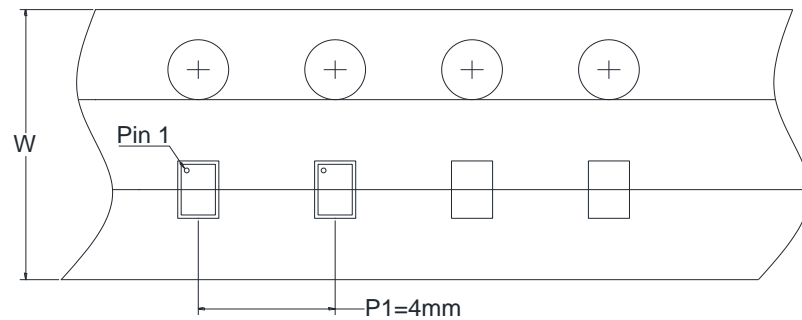
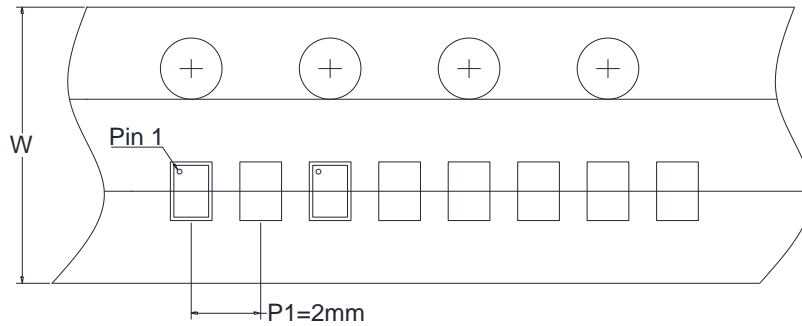
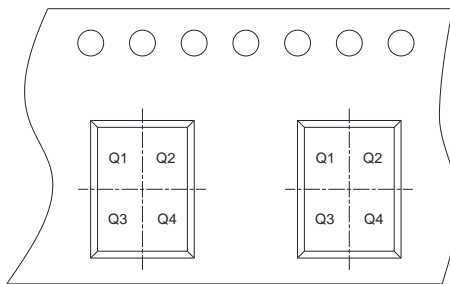
TAPE AND REEL INFORMATION
Reel Dimensions

Tape Dimensions

Quadrant Assignments For PIN1 Orientation In Tape



 User Direction of Feed

RD	Reel Dimension	<input checked="" type="checkbox"/> 7inch	<input type="checkbox"/> 13inch
W	Overall width of the carrier tape	<input checked="" type="checkbox"/> 8mm	<input type="checkbox"/> 12mm <input type="checkbox"/> 16mm
P1	Pitch between successive cavity centers	<input checked="" type="checkbox"/> 2mm	<input checked="" type="checkbox"/> 4mm <input type="checkbox"/> 8mm
Pin1	Pin1 Quadrant	<input checked="" type="checkbox"/> Q1	<input type="checkbox"/> Q2 <input type="checkbox"/> Q3 <input type="checkbox"/> Q4