

金龙机电股份有限公司
JINLONG MACHINERY & ELECTRONICS CO., LTD.

<h1 style="margin: 0;">规格书</h1> <h2 style="margin: 0;">SPECIFICATION</h2>

客户信息	客户名称/Customer	
	客户料号/Part No.	
	客户承认签章 Customer Approved Signatures	

文件编号/Spec No.	MX-S-21-003	版次 Rev.: A0
品名/Description	圆柱铁芯贴片马达/Cylindrical core SMT Motor	
型号/Part No.	Z3OC1T8219731	
设计/Designed	审核/Checked	批准/Approved
张敬波	董文志	Paul Tan
2021.3.12	2021.3.12	2021.3.12

地址:中国安徽省淮北市烈山区新蔡工业园青谷路 22 号

Add: LieShan District QingGu Road 22#,

Huaibei City, Anhui Province, China

电话/Tel: +86-561-2252005

传真/ Fax: +86-561-2252011

网址/Website: www.kotl.com.cn

1. 实用范围 Application

本说明书适用于圆柱铁芯贴片马达Z3OC1T8219731 型

This specification applies to Cylindrical core SMT Motor Z3OC1T8219731 model

2. 结构形式 Construction-form

序号 NO.	项目 Item	内容 Contents
2-1	电机结构 Motor construction	4mm×3mm的铁芯贴片马达 4mm×3mm cylindrical core SMT motor
2-2	磁极极数 Number of magnet poles	2 极(磁钢内置) 2-poles (inner magnet type)
2-3	换向方式 Rectifying method	金属电刷换向器装置 Metal brush and commutator

3. 标准使用条件 Standard operating condition

序号 NO.	项目 Item	规格 Specification	条件/备注 Condition / Remark
3-1	额定电压 Rated voltage	2.7V	加在端子两端的电压 Added to both ends of the terminal voltage
3-2	额定负荷 Rated load	振子 (R1.7 T=2.8) eccentric weight	振子重量约等于 0.24g eccentric weight is about equal to the weight of 0.24g.
3-3	旋转方向 Rotation direction	顺时针方向 CW	从输出端看, 并且电压正极接端子正极 When viewed from output side with +ve voltage applied to +ve terminal
3-4	摆放位置 Motor position	任意位置 Any position	
3-5	工作电压范围 Voltage range for use	DC 2.3V~3.2V	
3-6	使用环境 Operating conditions	-20℃~70℃ 0%~95%RH	常规湿度/ordinary humidity 不凝露/no condensation of moisture
3-7	贮存环境 Storage conditions	-40℃~85℃ 0%~95%RH	常规湿度/ordinary humidity 不凝露/no condensation of moisture/

4. 产品测试环境条件 Environmental Test Conditions

序号 NO.	项目 Item	测试环境条件 Environmental condition
4-1	温度 Temperature	20±2℃
4-2	湿度 Humidity	60±5% RH
4-3	电机体位 Motor Position	轴伸水平 Shaft Horizontal
4-4	电源 Power Supply	直流稳压电源/DC Power Supply DC2.7V±2%

备注: 所有的数据在温度 20±2℃, 湿度 60±5% RH的条件下测定。在对判定不发生异议时, 也可在温度 5~35℃, 湿度 45~85%RH的环境下测试。

NOTE: All data shall be based on the measurement under the temperature 20±2℃ and humidity 60±5% RH, however the range of temperature 5~35℃ and humidity 45~85%RH if there is no doubt about the judgment.

5. 机械特性 Mechanical Characteristic

序号 NO.	项目 Item	测试环境条件 Environmental condition	规格 Specification
5-1	外观尺寸 Configuration	游标卡尺 Vernier caliper	参考外形图纸 As specified in outline drawing
5-2	外观 Appearance	目测 Visual examination	无明显机械划痕、裂缝、锈迹、污点 No obvious evidence of mechanical damage、crack、rust and stain
5-3	重量 Weight	架盘天平 精度 0.1g Plate balance 0.1g	0.6g (Approx) (左右)
5-4	轴向间隙 Shaft end play	游标卡尺或百分表 Vernier caliper or Dial indicator	(0.05- 0.3) mm
5-5	振子固定力 Holding strength Of eccentric weight	测力计/Pulling force testing machine	50N (5.6kgf) Min

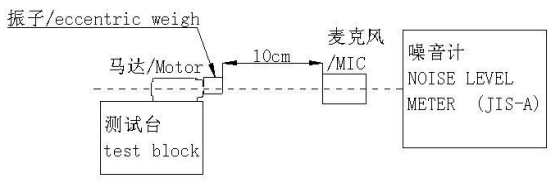
<p>5-6</p>	<p>机械噪声 Mechanical Noise</p>	 <p>测试场地：类半自由声场 额定电压，空载运行，背景噪声≤ 20 dB(A),电机固定在测试夹具上(轴伸水平)，拾音器沿轴向正对电机平面，距离 10 cm。 Test site: Class of semi-free field At rated voltage and free load, Back ground noise: 20 dB(A) Max, Fix the motor in a test jig (Shaft Horizontal). Microphone is faced to the flat of motor and recedes by 10cm</p>	<p>≤ 50dB(A)</p>
------------	----------------------------------	--	----------------------------------

6. 电气性能 Electrical characteristics

序号 NO.	项目 Item	测试环境条件 Environmental condition	规格 Specification
6-1	额定电流 Rated current	在额定电压及标准负荷（振子）下，5秒后读数。	85mA Max
6-2	额定转速 Rated speed	Read the data at rated voltage and rated load(eccentric weight)after 5S.	14000 \pm 2500 r. p. m
6-3	堵转电流 Stall current	在额定电压及标准负荷（振子）下，2秒后读数。 Read the data at rated voltage and rated load(eccentric weight)after 2S.	95mA Max
6-4	起动电压 Starting voltage	在额定负载（振子）下电枢的任意位置。 At rated load (eccentric weight) any position of rotor.	2.3V DC Max
6-5	端子阻抗 Terminal resistance	在 20 \pm 2 $^{\circ}$ C 下 At 20 \pm 2 $^{\circ}$ C	32.0 Ω \pm 6. 0 Ω
6-6	绝缘电阻 Insulation resistance	在 50V 直流下，导线和机壳间 At DC 50V between lead wire and case.	1M Ω Min

7. 信赖性试验 Reliability Test

序号 NO.	项目 Item	试验条件 Test condition	判定基准 Requirements
7-1	寿命测试 Life test	电压/Voltage: 2.7VDC 负荷/Load: 振子/ eccentric weight (R1.7 T=2.8 约 0.24g) 温度/Temperature/20±2℃ 相对湿度/Relative humidity: 60~70%RH 将马达固定在试验台上(轴向)/Lock the motor in a test fixture(Shaft horizontal) 试验方法 1/Test mode1: 连续运转至少 10 小时/10hrsnet running time 试验方法 2/Test mode2: 一个周期, 开 2.5 秒, 关 2.5 秒; 共 200000 个周期/1cycle, 2.5sec ON, 2.5sec OFF; 200000 cycles totally	在常温常湿下放置 4h 后, 马达应符合项 8-1、 8-2 的要求。 After 4 hours exposure in ordinary temperature and humidity, Motors shall be approved as specified in item 8-1、 8-2.
7-2	低温放置 Low temperature storage	温度/Temperature: -40±5℃; 时间/Time: 96h 湿度/Humidity: 常湿/ Ordinary Humidity	在常温常湿下放置 4h 后, 马达应符合项 8-1、 8-2 的要求。 After 4 hours exposure in ordinary temperature and humidity, Motors shall be approved as specified in item 8-1、 8-2.
7-3	高温放置 High temperature exposure	温度/Temperature: +85±5℃; 时间/Time: 96h 湿度/Humidity: 常湿/ Ordinary Humidity	
7-4	湿度测试 Humidity test	温度/Temperature: +40±5℃; 时间/Time: 96h 湿度/Humidity: 90±5%RH	
7-5	振动 Vibration	全振幅 /Displacement :1.5mm (p-p) 频率/Frequency:10 to 55Hz 周期/Period :20min范围内 (10~55~10Hz) /20 Minutes log sweep (10~55~10Hz) 方向/Direction:x、 y、 z 时间/Time:每 2h/Each 2 hours	测试结果应符合项 8-1、 8-2、 8-3 的要求。 After the test motors shall be approved as specified in item 8-1、 8-2、 8-3.

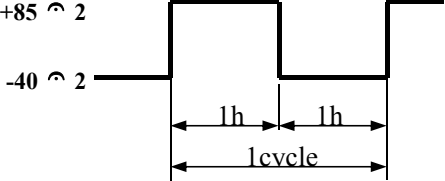
7-6	热冲击试验 Thermal Shock test	<p>温度Temperature : -40℃~ 85℃ 时间Time: 2h 循环周期数Circle cycle: 30cycles</p> 	<p>测试结果应符合项 8-1、8-2 的要求。 After the test motors shall be approved as specified in item 8-1、8-2.</p>
7-7	跌落试验 Drop test	<p>方向Direction: x,y,z 高度High: 1.5m 跌落次数: 每个方向各 2 次 Times: 2 times each direction 试验状态: 将电机放在重约 100 克的刚性较好的塑料盒子里, 自由地跌落至混凝土地面上 Test state: The motor is set into a rigid cubic plastic housing approximately weight 100g and fall free on the concrete floor</p>	<p>试验结束后, 电机应满足 8-1、8-2、8-3 的规定 After having finished the test, the motor should conform to the requirements of the items 8-1、8-2、8-3.</p>

8. 信赖性试验后的要求 Requirement After Reliable Test

序号 NO.	项目 Item	规格 Specification
8-1	额定转速 Rated speed	初始值±30% Initial data±30%
8-2	额定电流 Rated Current	初始值±35% Initial data±35%
8-3	起动电压 Starting voltage	≤ 2.3V

9. 包装要求 Package Require

9-1 卷盘包装 Reel Packing

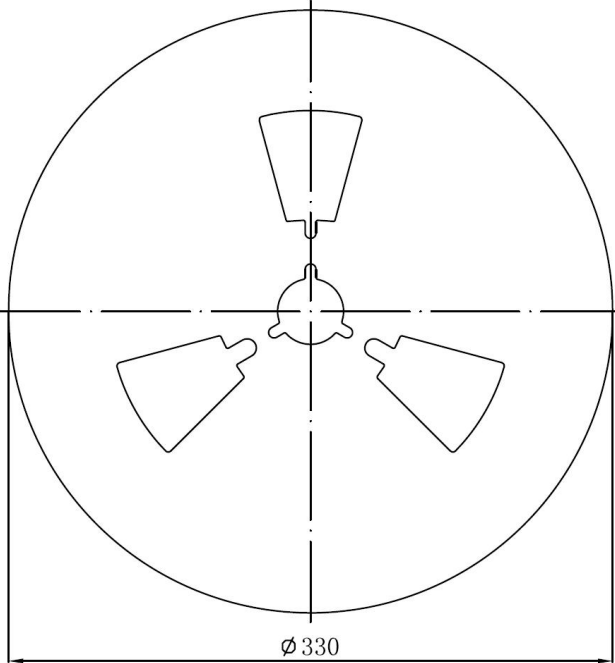
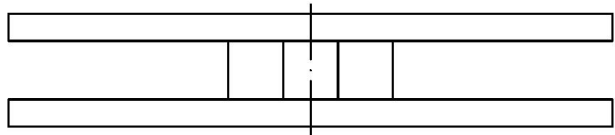

A 局部图/A Department

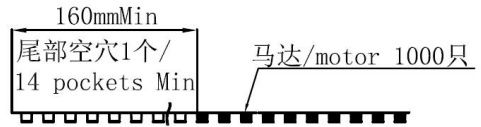

卷盘尾部/
End part

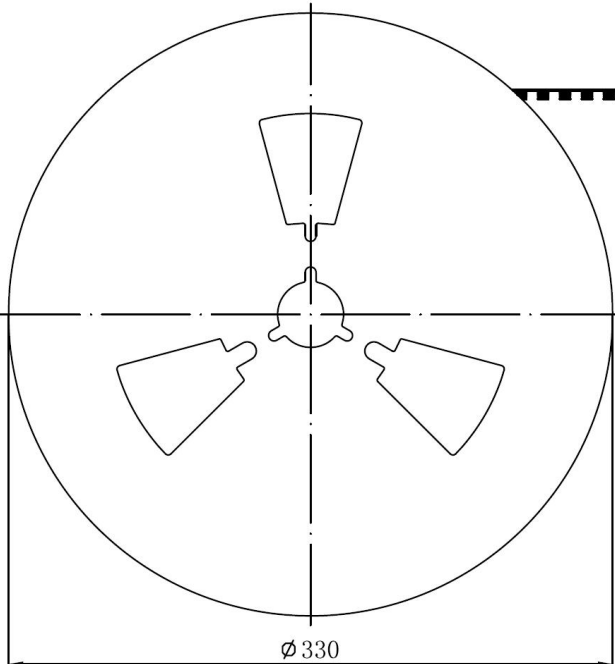
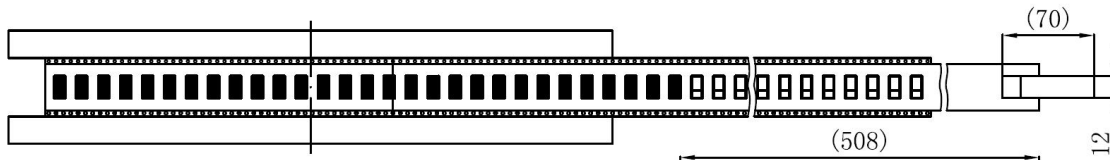

卷盘拆卸口/
Leader part

9-2 最终包装 Final Packaging

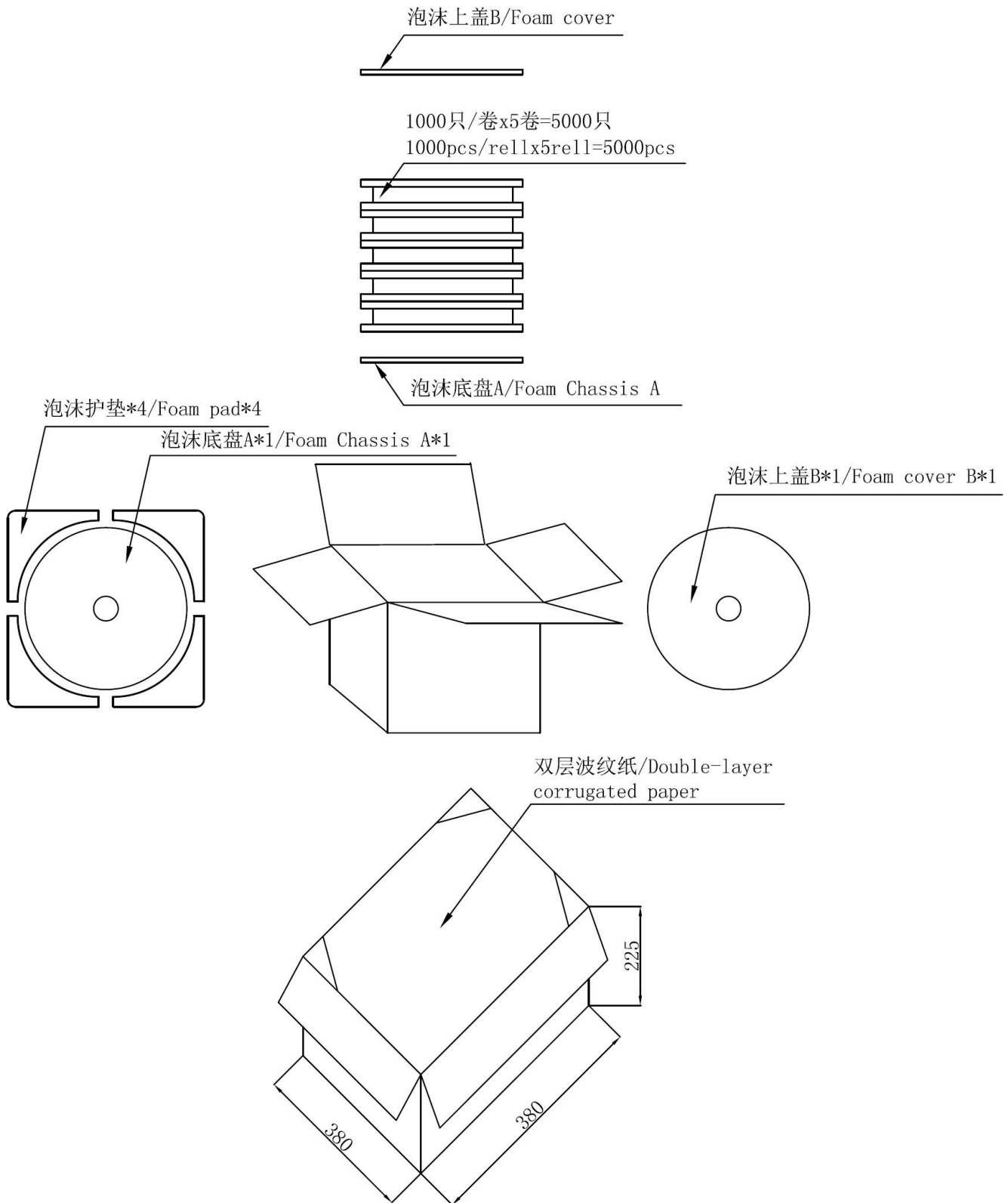

10. 注意事项 CAUTIONS**1) 使用容差 ALLOWABLE RANGE FOR USE**

注意电压及电流的使用范围，并且在本标准规定情况下使用电机，否则将相应降低电机的使用寿命和性能。

Pay attention to voltage and current ranges for use ,and use the vibration motor in the condition accordance with this specifications ,or the life and performance should be considerably reduced.

2) 移动电机 MOVE YOUR MOTOR

拿电机时，应轻拿轻放，应尽可能地利用外壳部分

请勿将其跌落或加以超过 5 公斤的压力。否则会引起电机的外部形态和电气特性的改变

Please deal with the motors gently, you should make use of the outer case as possible as you can.

Do not press the product with more than 0.5 kgf or drop it. It can cause the transformation of performance or external appearance.

电机在运输过程中应小心轻放，避免严重碰撞敲击引起的电机机身和性能受损。

Please lay the motors carefully in transportation to avoid any serious damage to the motor body or its electric function because of collision.

3) 储存 STORAGE

储存温度：-40℃~85℃

储存湿度：0%RH~95%RH

避免放置在高温、潮湿的环境中。

Storage temperature: -40℃~85℃

Storage relative humidity: 0%RH~95%RH

Avoids storing in high temperature、high humidity

马达应适当的操作、储存和运转环境中均不可存在腐蚀性气体。例如：H₂S、SO₂、NO₂、CL₂等。另外存储环境中不可有诸如硅、氰、甲醛水和苯酚等能放射出腐蚀性气体的物质，在电机的机械构造或装置中，如果存在腐蚀性气体，那么这会引起马达不运转。

For proper operation. storage and operating environment must not contain corrosive gases. For example H₂S. SO₂. NO₂. CL₂. etc. In addition storage environment must not have materials that emit corrosive gases especially from silicon. cyanic. formalin and phenol group. In the mechanism or the set. existence of corrosive gases may cause no rotation in motor.

4) 使用电机 HANDLING OF MOTOR

小心拿取、使用。

避免放置在磁性物体附近或接触其表面，这将影响其功效。

注意操作环境，尤其注意若铁粉被磁铁吸附，将出现噪音问题，降低使用寿命

-to handle and hold the vibration motor case softly.

-do not bring magnetized object near or contact with the surface of motor to avoid of performance being deteriorated.

-pay attention to the handling and working environments of motor, because such objects as iron powder if attracted by motor magnet, will cause noise characteristic deterioration, thus reducing the reliability.

请勿靠近磁体或有磁场的装置存放或运行电机

Please do not operate or store the motor near magnet or magnetic devices.

请在 6 个月内使用，请不要在高温、低温、高湿环境下存储。在使用和打开马达外包装时请避免水气凝结。

Make arrangement to limit the storage period to 6 months or less. Please do not store motor in high temperature. Low temperature. high humidity environment. Condensation of atmosphere must be avoided in motor usage or opening the packaging of the motor.

5) 电机接线 CONNECTION YOUR MOTOR:

不论使用任何方式将您的电源连接到您的电机，请注意不能用过大的力或过高的温度，否则会造成电机内部零件变形。

Whatever means you are to use to connect your supply to your motor please take care not to use so much force or heat that you cause distortion to components inside the motor.

(1)电机端子接线： 焊锡温度： 350°C 焊锡时间： 1 秒

Motor terminal: Soldering temperature: 350°C, Soldering time: 1sec.

(2)SMT温度时间示意图/Reflow temperature-time diagram

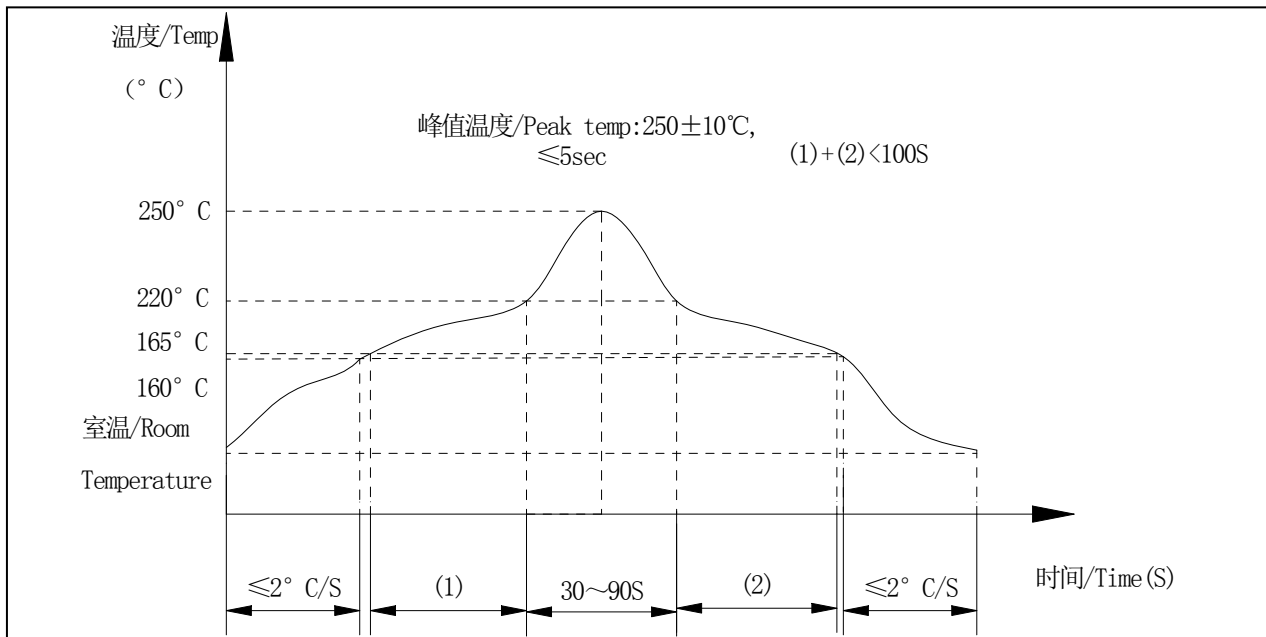

回流焊技术要求/Technical requirements for reflow

焊点最高峰值温度/Solder joint peak value of temperature: 260°C

液态线 (220°C) 以上时间/At the time of liquefaction temperature of more than: 30~90 秒

均温区要求/Average temperature zone requirements: 165°C~217°C <100 秒

预热温区要求/Preheat temperature zone requirements (<160°C): ≤2°C/秒

峰值温升要求/Peak temperature rise required: 1°C~3°C/秒

建议焊锡膏厚度/Suggest solder paste thickness 0.15mm

6) 过负荷 OVERLOADS:

请通电后不要长时间堵住机轴，并且马达转动时不要触碰振子。

Please don't stall the shaft for a long time after powering, and not to touch the weight when motor is rotating.

7) 危险环境 HAZARDOUS ENVIRONMENTS:

我司电机在正常环境中的抗腐蚀能力是符合要求的，但机壳上有少许区域存在的裸露金属对腐蚀比较敏感，因此未经咨询请不要在腐蚀环境中储存或使用电机。

The degree of protection against corrosion on **KOTL** motors is satisfactory only for normal environments. There are small sections of the housing in which some bare metal is exposed and is susceptible to corrosion. It is advisable not to store or use motors in corrosive environment without consultation with **KOTL**.

8) 其它说明 OTHER

马达轴向间隙处不应有杂物（如颗粒、纤维物、头发、胶带、胶水等）

There should be no sundries (such as grain, fibre, hair, small tape, glue etc.) in the shaft end play.

9) 请谨记 ALWAYS REMEMBER

金龙机电股份有限公司拥有一支专业的技术支持团队，致力于解决我们的电机在新的产品或新的应用中出现的问题，我们乐意与您建立良好的合作关系，我们乐意为您解决使用中遇到的各种问题。

that **KOTL** has a professional technical support team for the solution of problems on our motors that used in new products or new applications. We are proud of our good working relationship with our customers and we will be most pleased if we can assist you to find a solution to any problem that you may encounter.

11. 附件 ATTACHMENT

1) 电机外形图 Motor Outline Drawing

————— END —————

借(通)用件 登记
插图
描校
底图总号
签字
日期

1. RATED VOLTAGE: 2.7V
2. STALL CURRENT: 95mA(max)
3. RATED CURRENT: 85mA(max)
4. STARTING VOLTAGE: 2.3V(max)
5. RATED SPEED: 14000±2500RPM

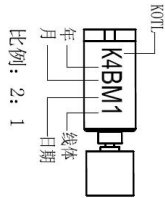
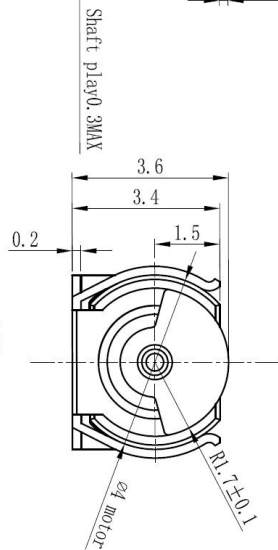
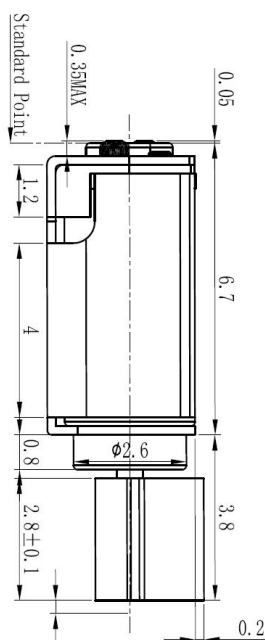
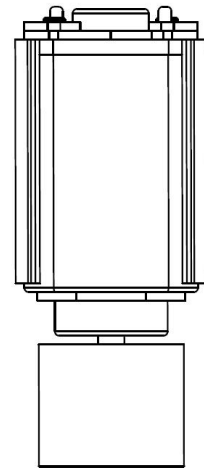
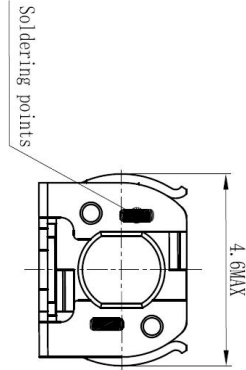

比例: 2: 1

1. 字体为方正楷体, 字高2mm, 颜色为黑色
2. "年"表示: 取末位数字(例如4表示2004年, 以此类推)
3. "月"表示: [1-9月份用该月数字、10月用"A"表示、11月用"B"表示、12月用"C"表示]
4. 装配车间(-)用"1"表示, 以此类推;
5. 日期的表示见下表:

印字	1	2	3	4	5	6	7	8
日期	1	2	3	4	5	6	7	8
印字	9	A	B	C	D	E	F	G
日期	9	10	11	12	13	14	15	16
印字	H	J	K	L	M	N	P	Q
日期	17	18	19	20	21	22	23	24
印字	R	S	T	U	V	W	X	Y
日期	25	26	27	28	29	30	31	

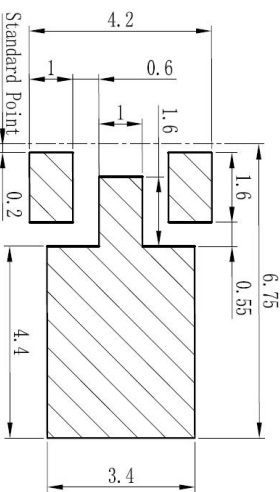
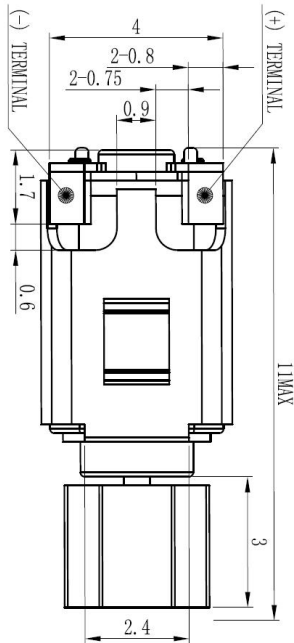

PCB Layout (Reference)

技术要求:
1. 未注公差尺寸: ±0.2

A/0

标记	处数	更改内容	签字	日期	图样标记	重量	比例
设计							7:1
制图							
校对							
工艺							
					共 张	第 张	

金龙机电股份有限公司

外观图

03.02.Z30C1T8219731