

SuperMOS – SOT-23 -30V V_{DSS} , $38m\Omega$ $R_{DS(on)}$, -4.5A I_D P-channel MOSFET

1. Description

The AO3407 is P-Channel enhancement MOS Field Effect Transistor. Uses advanced trench technology and design to provide excellent $R_{DS(ON)}$ with low gate charge. Device is suitable for use in DC-DC conversion, power switch and charging circuit. Standard Product AO3407 is Pb-free.

2. Features

- 30V, $R_{DS(ON)} < 38m\Omega$ @ $V_{GS} = -10V, I_D = -4.5A$
- $R_{DS(ON)} < 55m\Omega$ @ $V_{GS} = -4.5V, I_D = -3.0A$
- Fast Switching
- High density cell design for low $R_{DS(on)}$
- Material : Halogen free
- Reliable and rugged
- Avalanche Rated
- Low leakage current

3. Applications

- PWM applications
- Load switch
- Power management in portable/desktop PCs
- DC/DC conversion

4. Ordering Information

Part Number	Package	Material	Quantity per reel	Flammability Rating
AO3407	SOT-23	Halogen free	3,000 PCS	UL 94V-0

Table-1 Ordering information

5. Pin Configuration and Functions

Pin	Function	Outline	Circuit Diagram
1	Gate		
2	Source		
3	Drain		

Table-2 Pin configuration

6. Specification

Absolute Maximum Rating & Thermal Characteristics

Ratings at 25 °C ambient temperature unless otherwise specified.

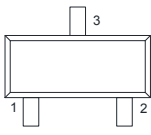
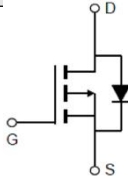
Parameter	Symbol	Limit	Unit
Drain-Source Voltage	BV_{DSS}	-30	V
Gate-Source Voltage	V_{GS}	± 20	V
Continuous Drain Current	$T_A=25^\circ\text{C}$	-4.5	A
	$T_A=100^\circ\text{C}$	-3.5	
Maximum Power Dissipation	$T_A=25^\circ\text{C}$	1.5	W
	$T_A=100^\circ\text{C}$	0.8	
Pulsed Drain Current	I_{DM}	-18	A
Operating Junction Temperature	T_J	150	°C
Storage Temperature Range	T_{stg}	-55 to +150	°C

Thermal resistance ratings

Single Operation				
Parameter	Symbol	Typical	Maximum	Unit
Junction-to-Ambient Thermal Resistance ^a	$R_{\theta JA}$	105		°C/W
Junction-to-Case Thermal Resistance	$R_{\theta JC}$	63		

Electrical Characteristics

At TA = 25°C unless otherwise specified

Parameter	Symbol	Test Conditions	Min.	Typ.	Max.	Unit
OFF CHARACTERISTICS						
Drain-to-Source Breakdown Voltage	BV_{DSS}	$V_{GS}=0V, I_D=-250\mu A$	-30			V
Zero Gate Voltage Drain Current	I_{DSS}	$V_{DS}=-30V, V_{GS}=0V$			-1	μA
Gate-to-source Leakage Current	I_{GSS}	$V_{DS}=0V, V_{GS}=\pm 20V$			± 100	nA
ON CHARACTERISTICS						
Gate Threshold Voltage	$V_{GS(TH)}$	$V_{GS}=V_{DS}, I_D=-250\mu A$	-0.9	-1.5	-2.0	V
Drain-to-source On-resistance	$R_{DS(on)}$	$V_{GS}=-10V, I_D=-4.5A$		38	48	m Ω
		$V_{GS}=-4.5V, I_D=-3.0A$		55	65	
CHARGES, CAPACITANCES AND GATE RESISTANCE						
Input Capacitance	C_{ISS}	$V_{GS}=0V$		550		pF
Output Capacitance	C_{OSS}	$V_{DS}=-15V$		75		
Reverse Transfer Capacitance	C_{RSS}	$f=1MHz$		63		
Gate Resistance	R_g	$f=1MHz$		10.5		Ω
Total Gate Charge	$Q_{G(TOT)}$	$V_{GS}=-10V$		6.5		nC
Gate-to-Source Charge	Q_{GS}	$V_{DS}=-15V$		1.1		
Gate-to-Drain Charge	Q_{GD}	$I_D=-4.5A$		1.3		
SWITCHING CHARACTERISTICS						
Turn-On Delay Time	$t_{d(ON)}$	$V_{GS}=-10V$		14		ns
Rise Time	t_r	$V_{DS}=-15V$		60		
Turn-Off Delay Time	$t_{d(OFF)}$	$R_L=3.5\Omega$		19		
Fall Time	t_f	$R_G=3\Omega$		11		
BODY DIODE CHARACTERISTICS						
Forward Voltage	V_{SD}	$V_{GS}=0V, I_S=-1.0A$		-0.7	-1	V
Reverse Recovery Time	t_{rr}	$V_{GS}=0V, I_{SD}=-4.5A,$		13.0		ns
Reverse Recovery Charge	Q_{rr}	$di/dt=100A/\mu s$		2.5		nC

7. Typical Characteristic

Figure 1. On-Regin Characteristics

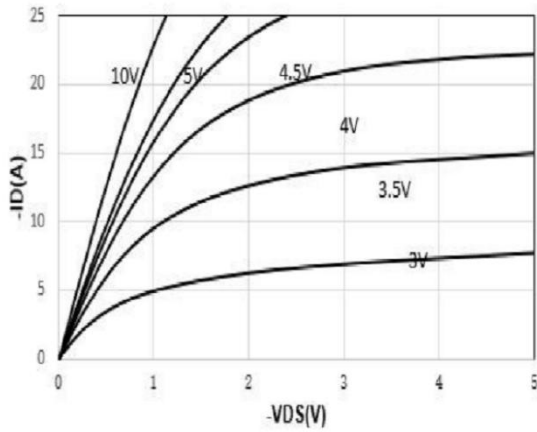

Figure 2. Transfer Characteristics

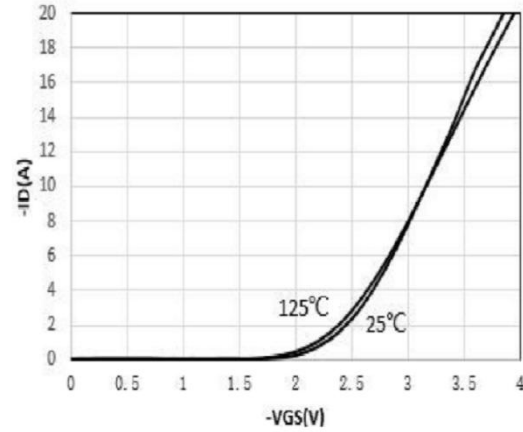

Figure 3. On-Resistance vs. Drain Current and Gate Voltage

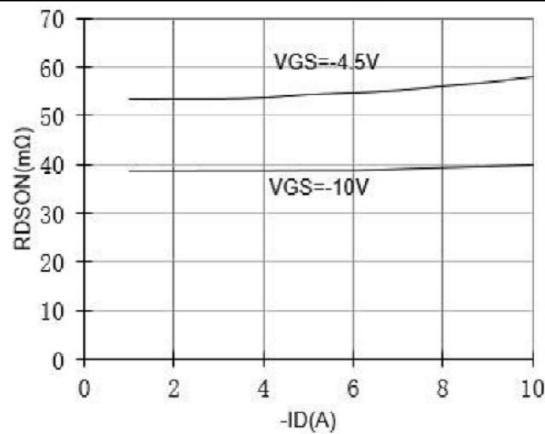

Figure 4. On-Resistance vs. Junction Temperature

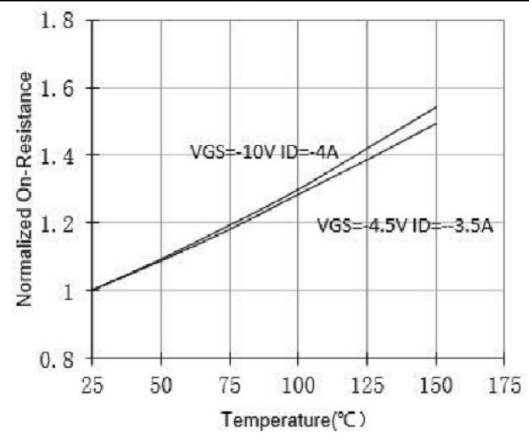

Figure 5. On-Resistance vs. Gate-Source Voltage

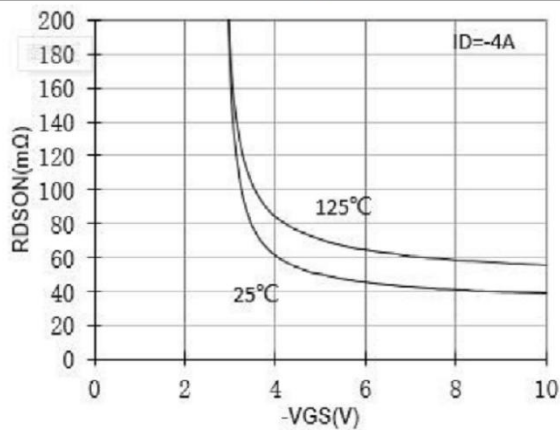
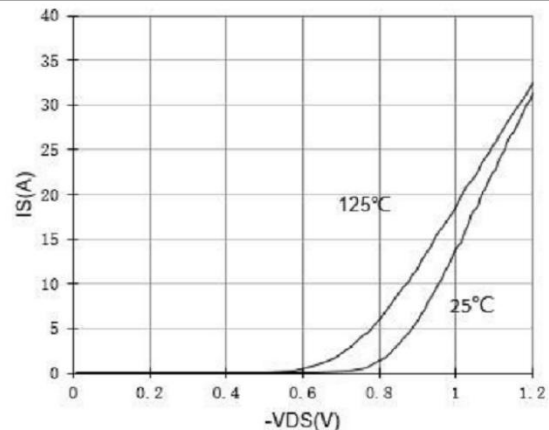

Figure 6. Body-Diode Characteristics



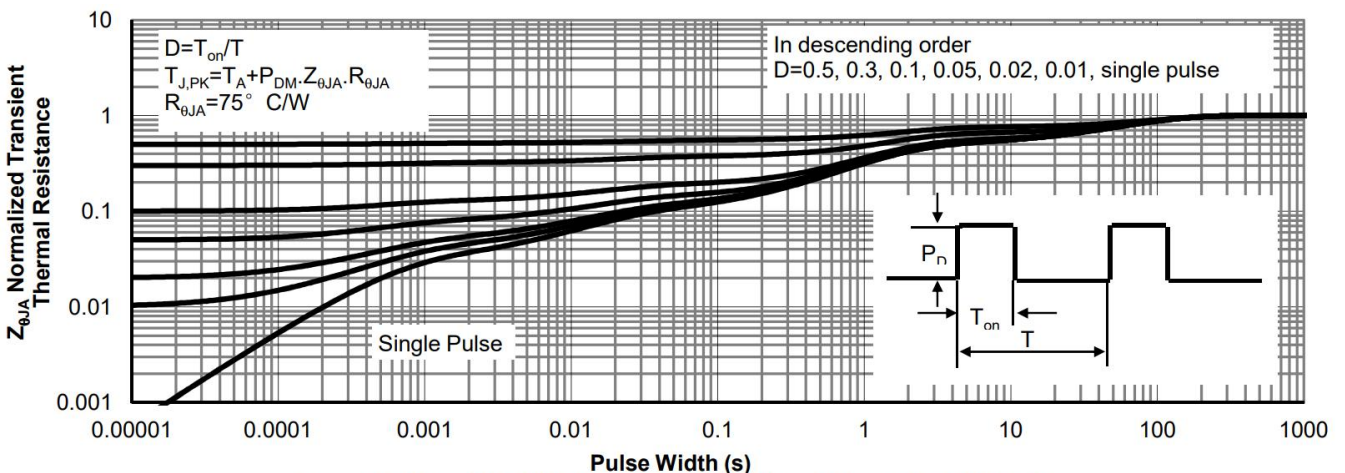
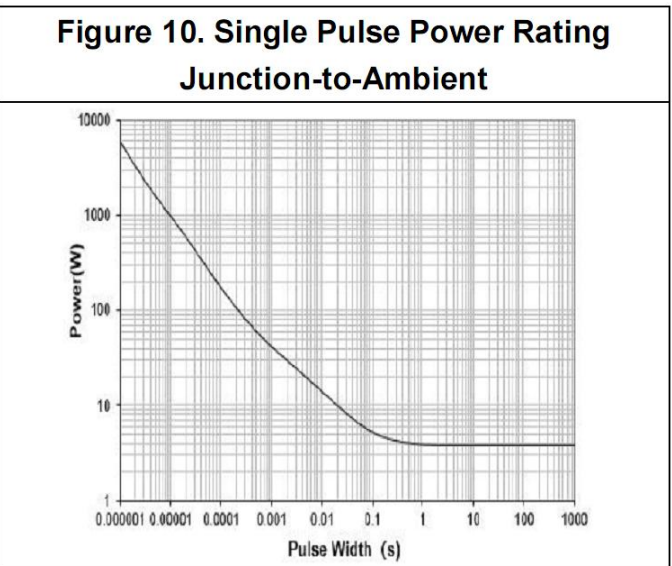
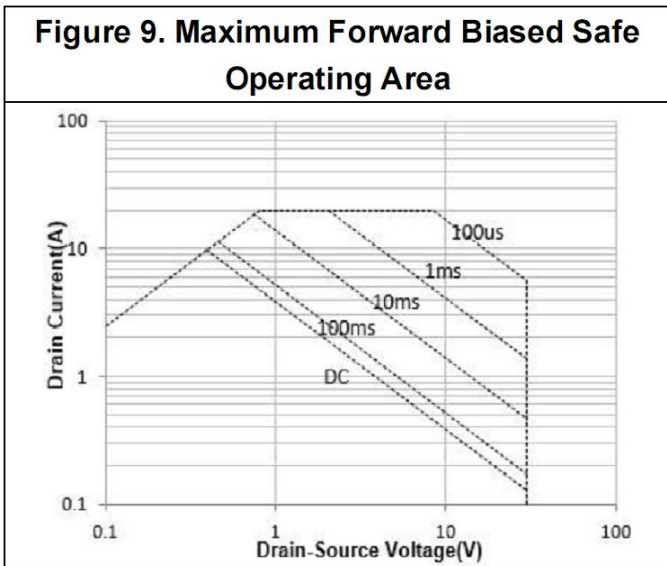
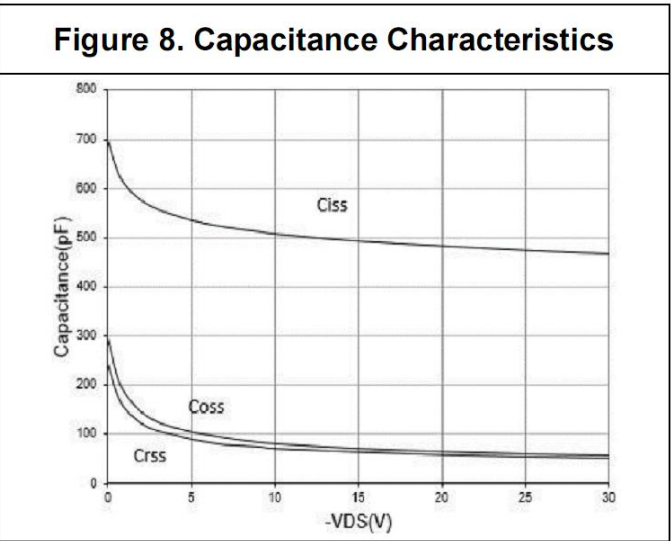
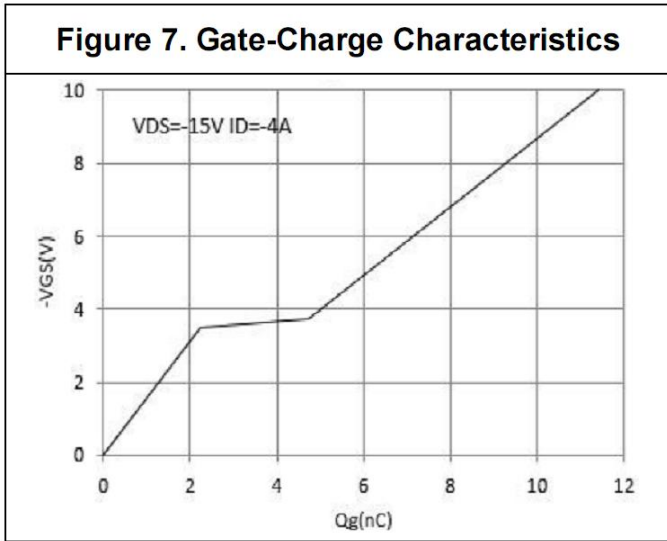
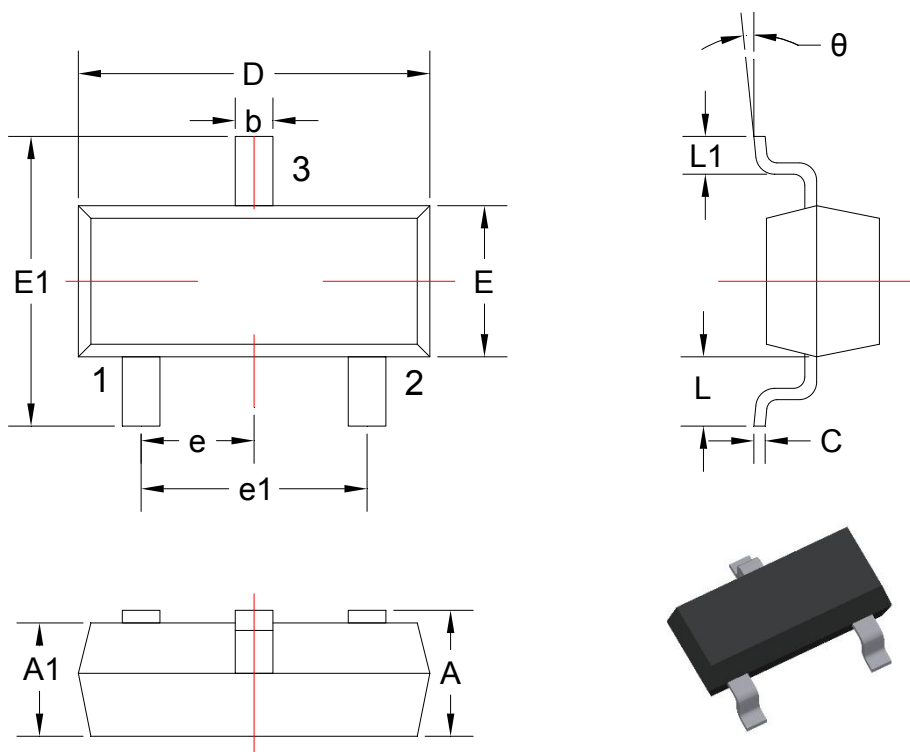

Figure 11: Normalized Maximum Transient Thermal Impedance(Note E)

8. Dimension and Patterns (SOT-23)



COMMON DIMENSIONS: UNITS OF MEASURE=MILLIMETER

Symbol	Dimensions		Symbol	Dimensions	
	Min.	Max.		Min.	Max.
A	0.900	1.150	E1	2.250	2.550
A1	0.900	1.050	e	0.950TYP	
b	0.300	0.500	e1	1.800	2.000
c	0.080	0.150	L	0.550REF	
D	2.800	3.00	L1	0.300	0.500
E	1.200	1.400	θ	0°	8°

DISCLAIMER

ELECSUPER PROVIDES TECHNICAL AND RELIABILITY DATA (INCLUDING DATASHEETS), DESIGN RESOURCES (INCLUDING REFERENCE DESIGNS), APPLICATION OR OTHER DESIGN ADVICE, SAFETY INFORMATION, AND OTHER RESOURCES “AS IS” AND WITH ALL FAULTS, AND DISCLAIMS ALL WARRANTIES, EXPRESS AND IMPLIED, INCLUDING WITHOUT LIMITATION ANY IMPLIED WARRANTIES OF MERCHANTABILITY, FITNESS FOR A PARTICULAR PURPOSE OR NON-INFRINGEMENT OF THIRD PARTY INTELLECTUAL PROPERTY RIGHTS.

These resources are intended for skilled developers designing with ElecSuper products. You are solely responsible for

- (1) selecting the appropriate ElecSuper products for your application;
- (2) designing, validating and testing your application;
- (3) ensuring your application meets applicable standards, and any other safety, security, or other requirements.

These resources are subject to change without notice. ElecSuper grants you permission to use these resources only for development of an application that uses the ElecSuper products described in the resource. Other reproduction and display of these resources are prohibited. No license is granted to any other ElecSuper intellectual property right or to any third party intellectual property right. ElecSuper disclaims responsibility for, and you will fully indemnify ElecSuper and its representatives against, any claims, damages, costs, losses, and liabilities arising out of your use of these resources. ElecSuper's products are provided subject to ElecSuper's Terms of Sale or other applicable terms available either on www.elecsuper.com or provided in conjunction with such ElecSuper products. ElecSuper's provision of these resources does not expand or otherwise alter ElecSuper's applicable warranties or warranty disclaimers for ElecSuper products.