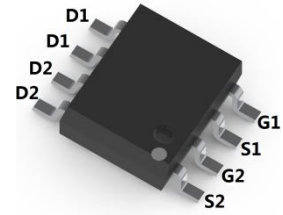
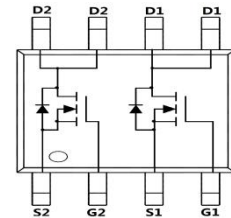

Dual N-Channel Enhancement Mode Field Effect Transistor
FEATURES

- Low on-resistance: $V_{DS}=30V, I_D=6.9A, R_{DS(ON)} \leq 28m\Omega @ V_{GS}=10V$
- Low gate charge
- For synchronous rectifier applications
- Surface Mount device

SOP-8

MECHANICAL DATA

- Case: SOP-8
- Case Material: Molded Plastic. UL flammability
- Classification Rating: 94V-0
- Weight: 0.3 grams (approximate)

MAXIMUM RATINGS ($T_A = 25^\circ C$ unless otherwise noted)

| Parameter | Symbol | Value | Unit |
|---|-----------------|--------------------|--------------|
| Drain-source voltage | V_{DS} | 30 | V |
| Gate-source voltage | V_{GS} | ± 20 | V |
| Continuous drain current | I_D | $T_A = 25^\circ C$ | 6.9 |
| | | $T_A = 70^\circ C$ | 5.8 |
| Pulsed drain current | I_{DM} | 30 | A |
| Power dissipation | P_D | $T_A = 25^\circ C$ | 2 |
| | | $T_A = 70^\circ C$ | 1.44 |
| Thermal resistance from Junction to ambient | $R_{\theta JA}$ | 110 | $^\circ C/W$ |
| Thermal resistance from Junction to Lead | $R_{\theta JL}$ | 40 | $^\circ C/W$ |
| Junction temperature | T_J | 150 | $^\circ C$ |
| Storage temperature | T_{STG} | -55 ~ +150 | $^\circ C$ |

ELECTRICAL CHARACTERISTICS ($T_A = 25^\circ C$ unless otherwise specified)

| Parameter | Symbol | Min | Typ | Max | Unit | Conditions |
|------------------------------------|-----------------|-----|-------|-----------|------------|---|
| Drain-Source breakdown voltage | $V_{(BR)DSS}^*$ | 30 | | | V | $V_{GS}=0V, I_D=250\mu A$ |
| Zero gate voltage drain current | I_{DSS}^* | | | 1 | μA | $V_{DS}=24V, V_{GS}=0V$ |
| Gate-body leakage current | I_{GSS}^* | | | ± 100 | nA | $V_{DS}=0V, V_{GS}=\pm 20V$ |
| Gate-threshold voltage | $V_{GS(th)}^*$ | 1 | 1.9 | 3 | V | $V_{DS}=V_{GS}, I_D=250\mu A$ |
| On-State Drain Current | $I_{D(ON)}^*$ | 20 | | | A | $V_{DS}=5V, V_{GS}=4.5V$ |
| Drain-source on-resistance | $R_{DS(ON)}^*$ | | 22.5 | 28 | m Ω | $V_{GS}=10V, I_D=6.9A,$ |
| | | | 31.3 | 38 | m Ω | $V_{GS}=10V, I_D=6.9A, T_J=125^\circ C$ |
| | | | 34.5 | 42 | m Ω | $V_{GS}=4.5V, I_D=5A$ |
| Forward transconductance | g_{FS} | 10 | 15.4 | | S | $V_{DS}=5V, I_D=5A$ |
| Diode forward voltage | V_{SD} | | 0.76 | 1 | V | $I_S=1A, V_{GS}=0V$ |
| Diode forward current | I_S | | | 3 | A | |
| Input capacitance | C_{iss} | | 680 | 820 | pF | |
| Output capacitance | C_{oss} | | 102 | | pF | $V_{DS}=15V, V_{GS}=0V, f=1MHz$ |
| Reverse transfer capacitance | C_{rss} | | 77 | | pF | |
| Gate resistance | R_g | | 3 | 3.6 | Ω | $V_{DS}=0V, V_{GS}=0V, f=1MHz$ |
| Total gate charge | Q_g | | 6.74 | 8.1 | nC | $V_{GS}=4.5V, V_{DS}=15V, I_D=6.9A$ |
| | | | 13.84 | 17 | nC | |
| Gate-source charge | Q_{gs} | | 1.82 | | nC | $V_{GS}=10V, V_{DS}=15V, I_D=6.9A$ |
| Gate-drain charge | Q_{gd} | | 3.2 | | nC | |
| Turn-on delay time | $t_{d(on)}$ | | 4.6 | 7 | nS | |
| Turn-on rise time | t_r | | 4.1 | 6.2 | nS | $V_{GS}=10V, V_{DS}=15V,$ |
| Turn-off delay time | $t_{d(off)}$ | | 20.6 | 30 | nS | $R_{GEN}=3\Omega, R_L=2.2\Omega$ |
| Turn-off fall time | t_f | | 5.2 | 7.5 | nS | |
| Body Diode Reverse Recovery Time | t_{rr} | | 16.5 | 20 | nS | $I_F=6.9A, di/dt=100A/\mu s$ |
| Body Diode Reverse Recovery Charge | Q_{rr} | | 7.8 | 10 | nC | $I_F=6.9A, di/dt=100A/\mu s$ |

*Pulse test ; Pulse width =80 μs , Duty cycle $\leq 0.5\%$.

Dual N-Channel Enhancement Mode Field Effect Transistor

TYPICAL ELECTRICAL AND THERMAL CHARACTERISTICS

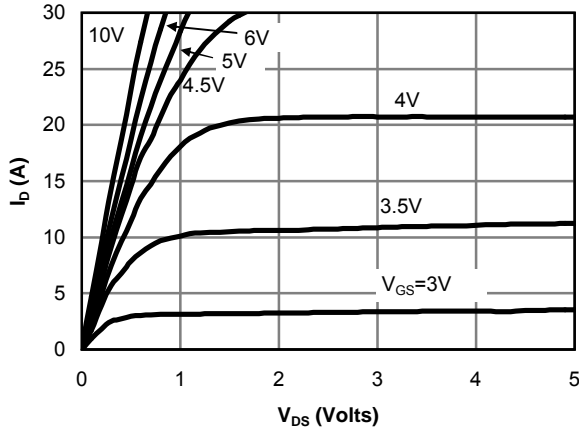

Fig 1: On-Region Characteristics

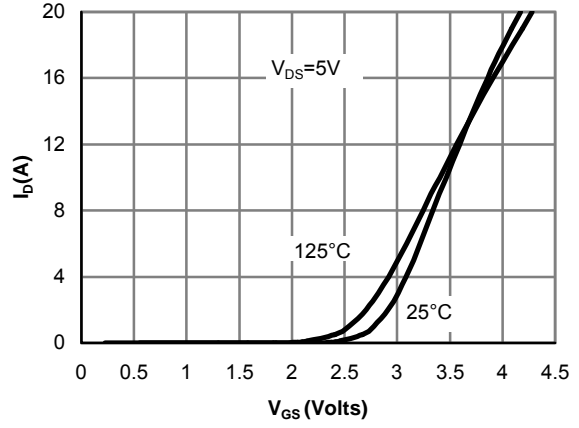

Figure 2: Transfer Characteristics

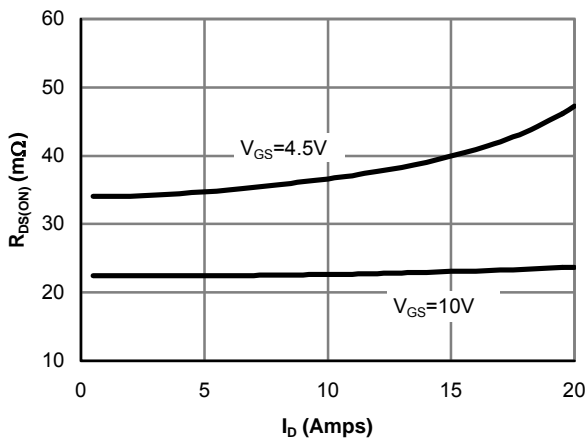

Figure 3: On-Resistance vs. Drain Current and Gate Voltage

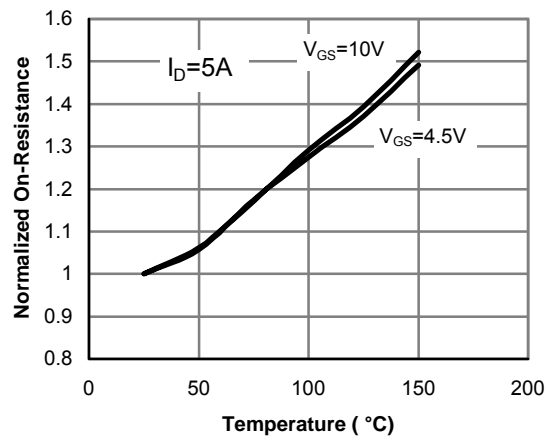

Figure 4: On-Resistance vs. Junction Temperature

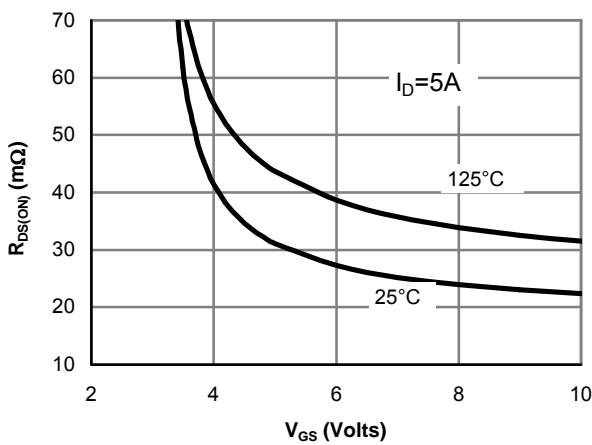

Figure 5: On-Resistance vs. Gate-Source Voltage

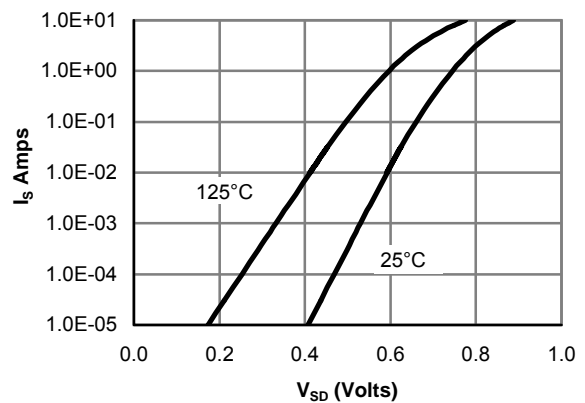

Figure 6: Body diode characteristics

Dual N-Channel Enhancement Mode Field Effect Transistor

TYPICAL ELECTRICAL AND THERMAL CHARACTERISTICS

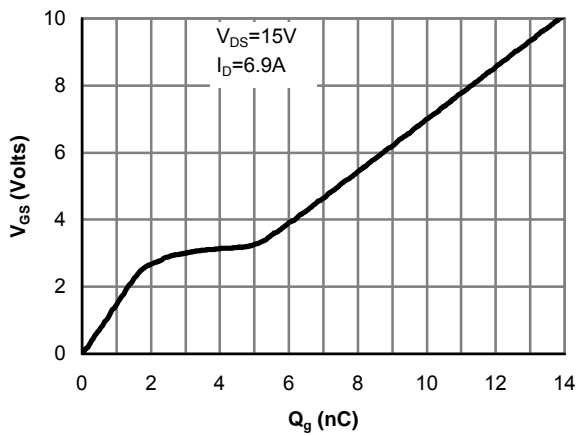

Figure 7: Gate-Charge characteristics

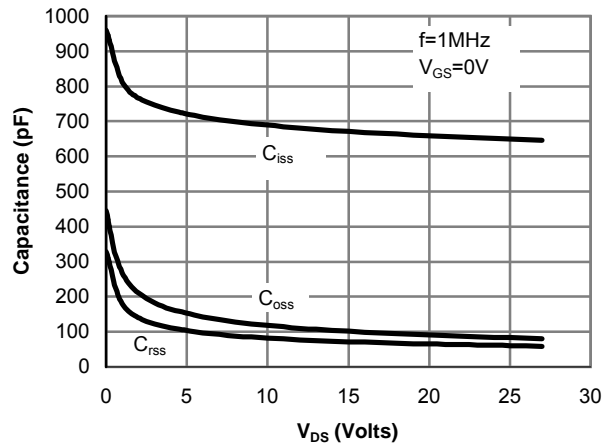

Figure 8: Capacitance Characteristics

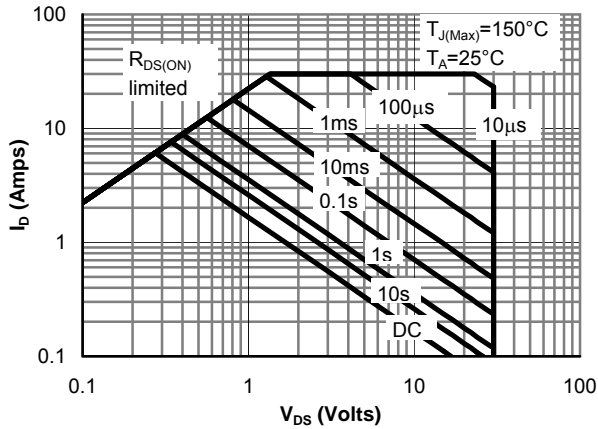

Figure 9: Maximum Forward Biased Safe Operating Area

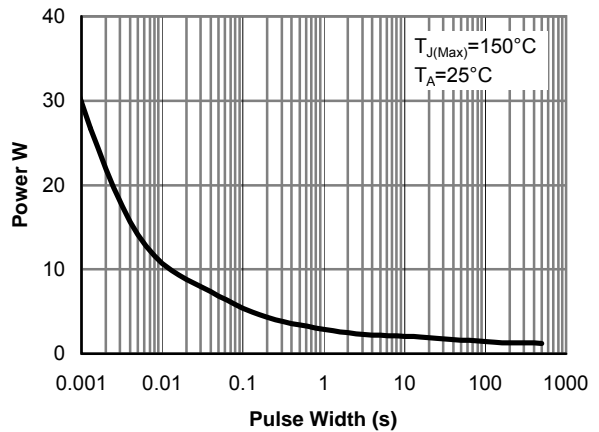

Figure 10: Single Pulse Power Rating Junction-to-Ambient

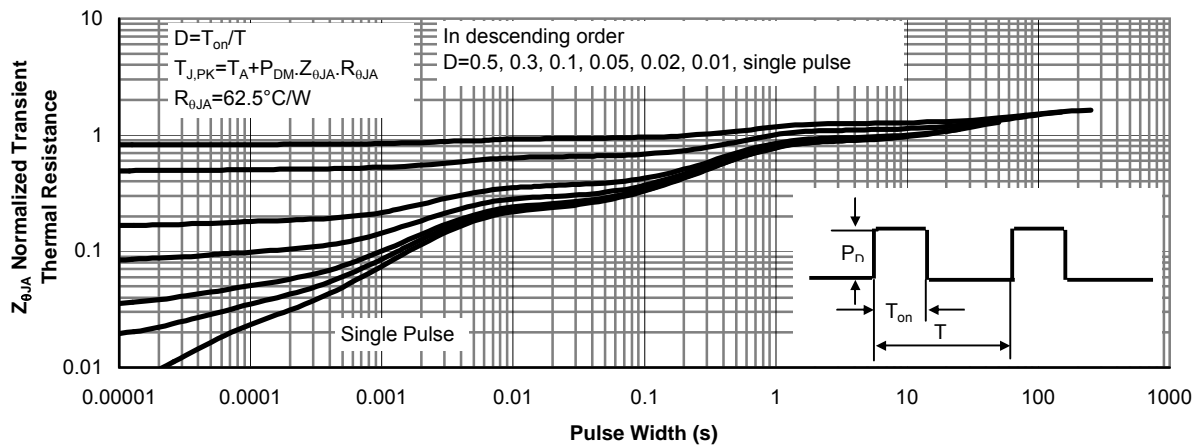
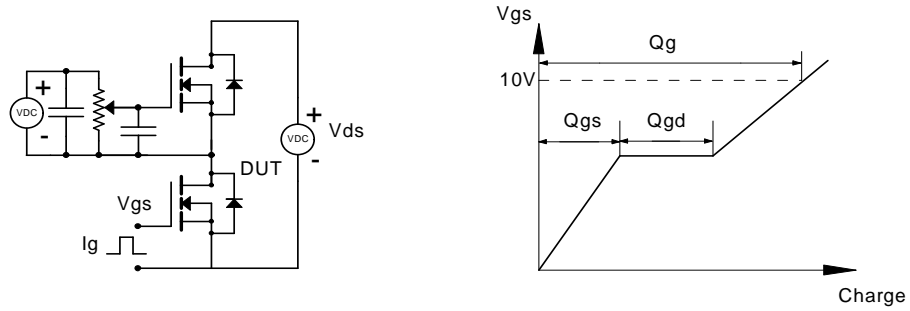

Figure 11: Normalized Maximum Transient Thermal Impedance

Dual N-Channel Enhancement Mode Field Effect Transistor

Gate Charge Test Circuit & Waveform



Resistive Switching Test Circuit & Waveforms

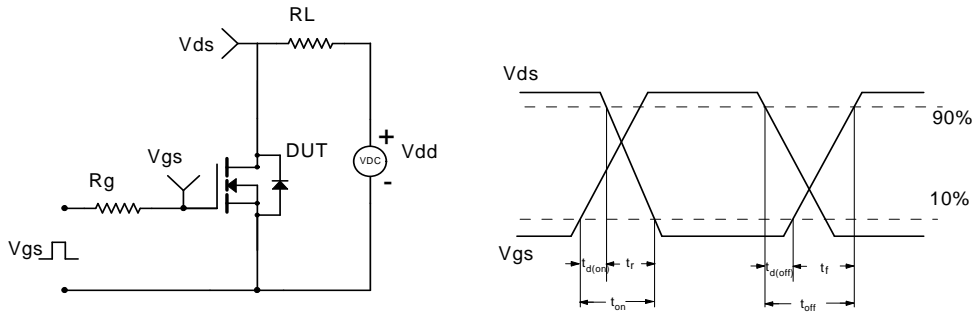

Unclamped Inductive Switching (UIS) Test Circuit & Waveforms

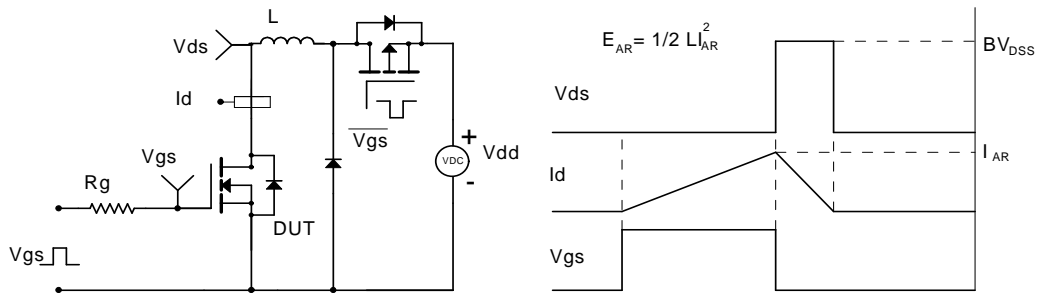

Diode Recovery Test Circuit & Waveforms

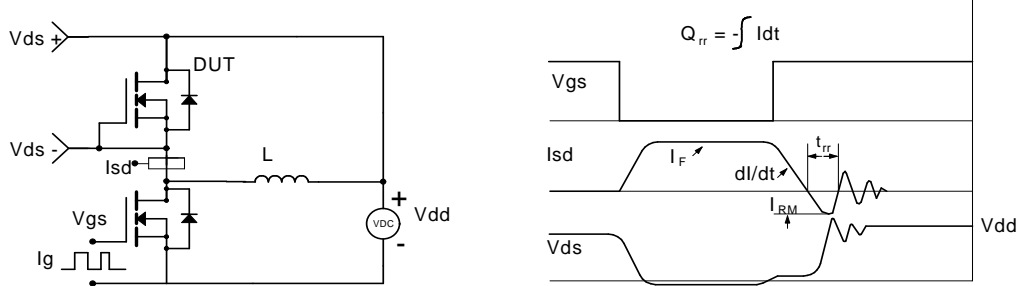

Dual N-Channel Enhancement Mode Field Effect Transistor

SOP-8 Package Outline Dimensions

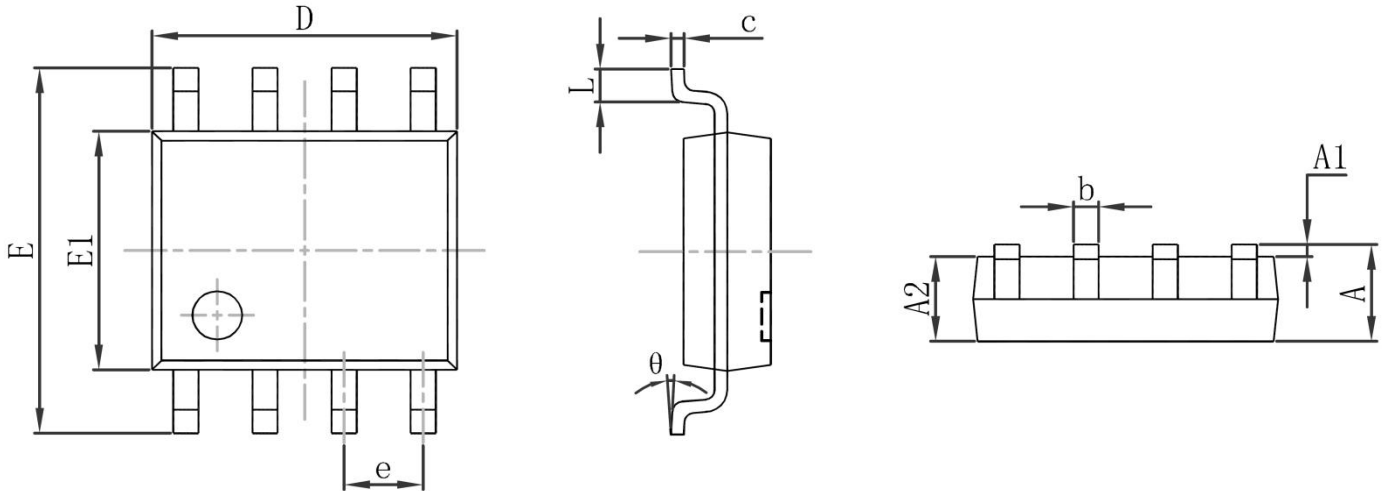

| Symbol | Dimensions In Millimeters | | Dimensions In Inches | |
|--------|---------------------------|-------|----------------------|-------|
| | Min. | Max. | Min. | Max. |
| A | 1.350 | 1.750 | 0.053 | 0.069 |
| A1 | 0.100 | 0.250 | 0.004 | 0.010 |
| A2 | 1.350 | 1.550 | 0.053 | 0.061 |
| b | 0.330 | 0.510 | 0.013 | 0.020 |
| c | 0.170 | 0.250 | 0.007 | 0.010 |
| D | 4.800 | 5.000 | 0.189 | 0.197 |
| e | 1.270(BSC) | | 0.050 (BSC) | |
| E | 5.800 | 6.200 | 0.228 | 0.244 |
| E1 | 3.800 | 4.000 | 0.150 | 0.157 |
| L | 0.400 | 1.270 | 0.016 | 0.050 |
| θ | 0° | 8° | 0° | 8° |

SOP-8 Suggested Pad Layout

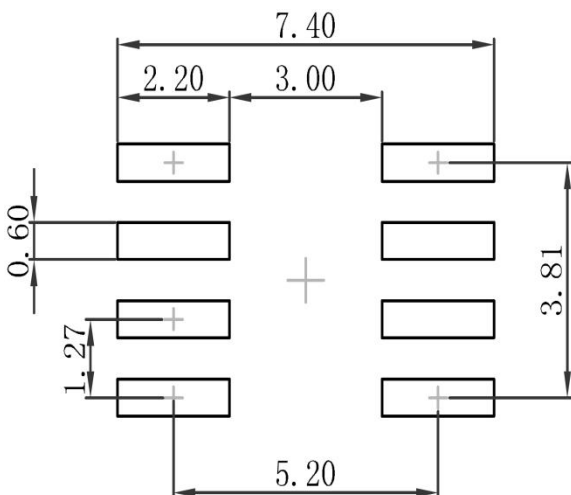

Note:

1. Controlling dimension: in millimeters
2. General tolerance: ±0.05mm
3. The pad layout is for reference purposes only

Dual N-Channel Enhancement Mode Field Effect Transistor

SOP-8 Tape and Reel

SOP-8 Embossed Carrier Tape

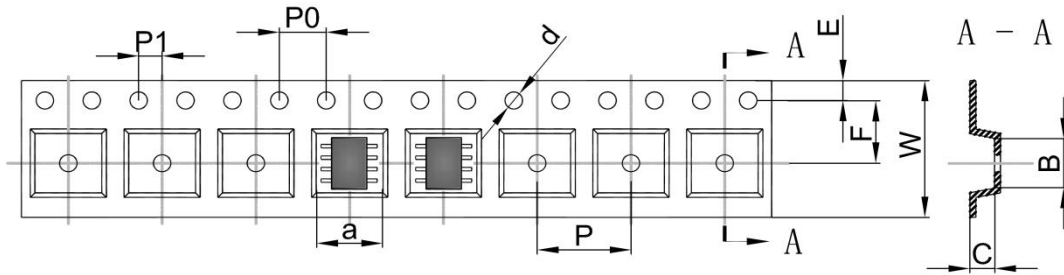

| DIMENSIONS ARE IN MILLIMETER | | | | | | | | | | |
|------------------------------|------|------|------|-------|------|------|------|------|------|-------|
| TYPE | A | B | C | d | E | F | P0 | P | P1 | W |
| SOP-8 | 6.40 | 5.40 | 2.10 | Ø1.50 | 1.75 | 5.50 | 4.00 | 8.00 | 2.00 | 12.00 |
| TOLERANCE | ±0.1 | ±0.1 | ±0.1 | ±0.1 | ±0.1 | ±0.1 | ±0.1 | ±0.1 | ±0.1 | ±0.1 |

SOP-8 Tape Leader and Trailer

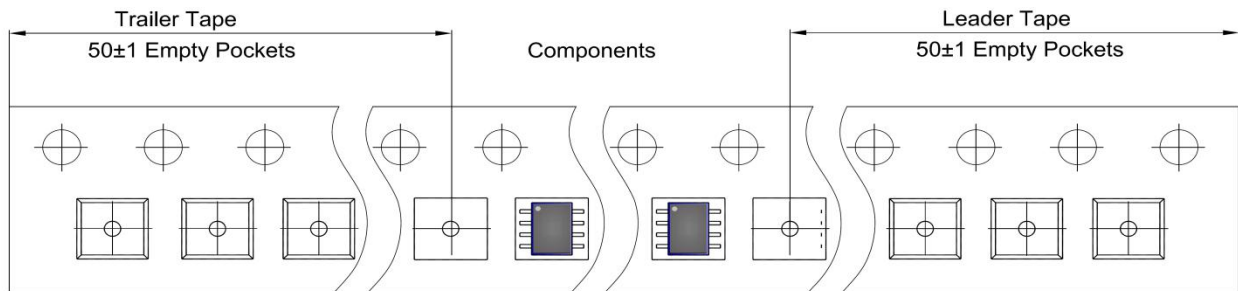

SOP-8 Reel

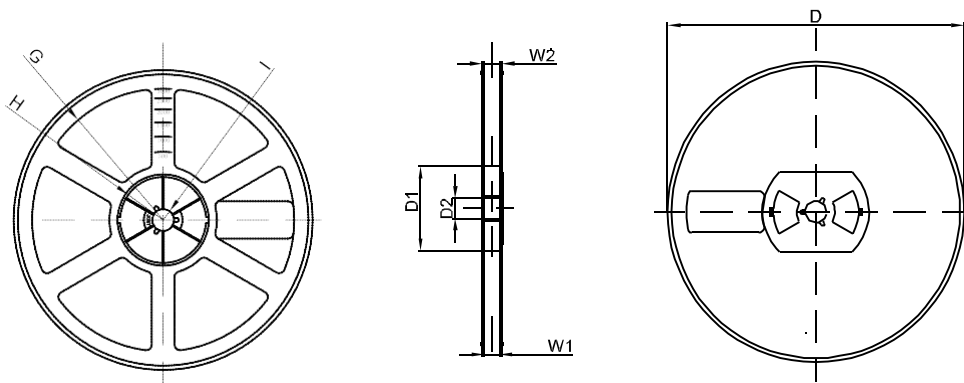

| DIMENSIONS ARE IN MILLIMETER | | | | | | | | |
|------------------------------|---------|--------|-------|---------|--------|-------|-------|-------|
| REEL OPTION | D | D1 | D2 | G | H | I | W1 | W2 |
| 13" DIA | Ø330.00 | 100.00 | 13.00 | R151.00 | R56.00 | R6.50 | 12.40 | 17.60 |
| TOLERANCE | ±2 | ±1 | ±1 | ±1 | ±1 | ±1 | ±1 | ±1 |