

N-Channel Enhancement Mode Field Effect Transistor

PDFN 5X6

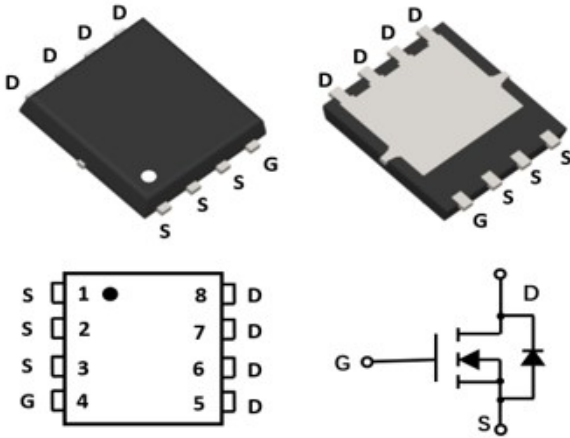

Product Summary

- V_{DS} 100V
- I_D 90A
- $R_{DS(ON)}$ (at $V_{GS}=10V$) <5.0mohm
- $R_{DS(ON)}$ (at $V_{GS}=4.5V$) <7.1mohm
- 100% UIS Tested
- 100% ∇V_{DS} Tested

General Description

- Split gate trench MOSFET technology
- Excellent package for heat dissipation
- High density cell design for low $R_{DS(ON)}$

Applications

- Power switching application
- Hard switched and high frequency circuits
- Uninterruptible power supply

■ Absolute Maximum Ratings ($T_A=25^\circ\text{C}$ unless otherwise noted)

Parameter		Symbol	Limit	Unit
Drain-source Voltage		V_{DS}	100	V
Gate-source Voltage		V_{GS}	± 20	V
Drain Current	$T_c=25^\circ\text{C}$	I_D	90	A
	$T_c=100^\circ\text{C}$		57	
Pulsed Drain Current ^A		I_{DM}	360	A
Avalanche energy ^B		E_{AS}	400	mJ
Total Power Dissipation ^C	$T_c=25^\circ\text{C}$	P_D	120	W
	$T_c=100^\circ\text{C}$		48	
Junction and Storage Temperature Range		T_J, T_{STG}	-55~+150	$^\circ\text{C}$

■ Thermal resistance

Parameter		Symbol	Typ	Max	Units
Thermal Resistance Junction-to-Ambient ^D	$t \leq 10\text{S}$	$R_{\theta JA}$	15	20	$^\circ\text{C/W}$
Thermal Resistance Junction-to-Ambient ^D	Steady-State		40	50	
Thermal Resistance Junction-to-Case	Steady-State	$R_{\theta JC}$	0.84	1.04	

■ Ordering Information (Example)

PREFERRED P/N	PACKING CODE	Marking	MINIMUM PACKAGE(pcs)	INNER BOX QUANTITY(pcs)	OUTER CARTON QUANTITY(pcs)	DELIVERY MODE
YJG90G10A	F1	YJG90G10A	5000	10000	100000	13" reel



YJG90G10A

■ Electrical Characteristics (T_J=25°C unless otherwise noted)

Parameter	Symbol	Conditions	Min	Typ	Max	Units
Static Parameter						
Drain-Source Breakdown Voltage	BV _{DSS}	V _{GS} = 0V, I _D =250μA	100			V
Zero Gate Voltage Drain Current	I _{DSS}	V _{DS} =100V, V _{GS} =0V			1	μA
Gate-Body Leakage Current	I _{GSS}	V _{GS} = ±20V, V _{DS} =0V			±100	nA
Gate Threshold Voltage	V _{GS(th)}	V _{DS} = V _{GS} , I _D =250μA	1.0	1.8	2.5	V
Static Drain-Source On-Resistance	R _{DS(on)}	V _{GS} =10V, I _D =20A		4.1	5.0	mΩ
		V _{GS} =4.5V, I _D =20A		5.7	7.1	mΩ
Diode Forward Voltage	V _{SD}	I _S =20A, V _{GS} =0V			1.3	V
Maximum Body-Diode Continuous Current	I _S				90	A
Gate resistance	R _G	f=1MHz, Open drain		0.9		Ω
Dynamic Parameters						
Input Capacitance	C _{iss}	V _{DS} =50V, V _{GS} =0V, f=1MHZ		3927		pF
Output Capacitance	C _{oss}			1658		
Reverse Transfer Capacitance	C _{rss}			36		
Switching Parameters						
Total Gate Charge	Q _g	V _{GS} =10V, V _{DS} =50V, I _D =20A		66		nC
Gate-Source Charge	Q _{gs}			15.4		
Gate-Drain Charge	Q _{gd}			10.6		
Reverse Recovery Charge	Q _{rr}	I _F =20A, di/dt=100A/us		82		ns
Reverse Recovery Time	t _{rr}			64		
Turn-on Delay Time	t _{D(on)}	V _{GS} =10V, V _{DD} =50V, I _D =20A R _{GEN} =2.2Ω		17.6		ns
Turn-on Rise Time	t _r			34.7		
Turn-off Delay Time	t _{D(off)}			43.8		
Turn-off fall Time	t _f			61.4		

A. Repetitive rating; pulse width limited by max. junction temperature.

B. V_{DD}=50V, R_G=25Ω, L=2Mh, I_{AS}=31A.

C. P_g is based on max. junction temperature, using junction-case thermal resistance.

D. The value of R_{θJA} is measured with the device mounted on 1in2 FR-4 board with 2oz. Copper, in a still air environment with T_A=25° C. The Power dissipation PDSM is based on R_{θJA} ≤ 10s and the maximum allowed junction temperature of 150° C. The value in any given application depends on the user's specific board design.



■ Typical Performance Characteristics

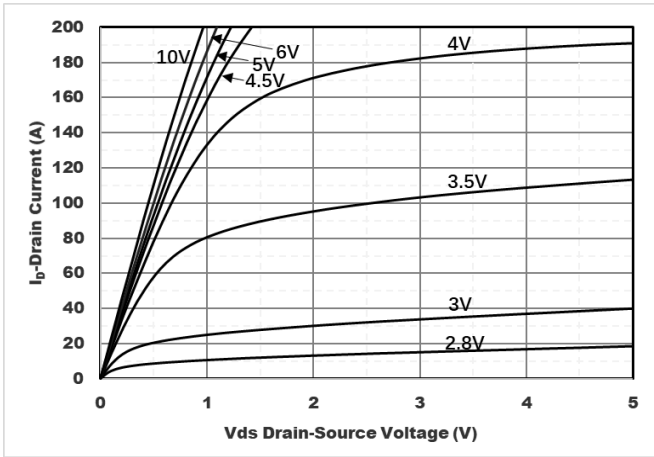

Figure1. Output Characteristics

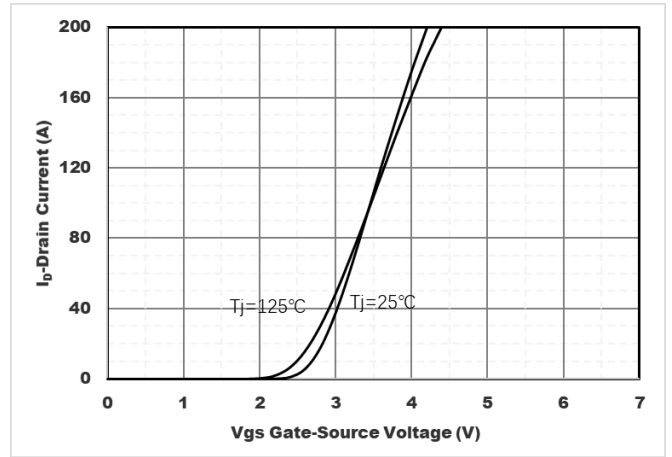

Figure2. Transfer Characteristics

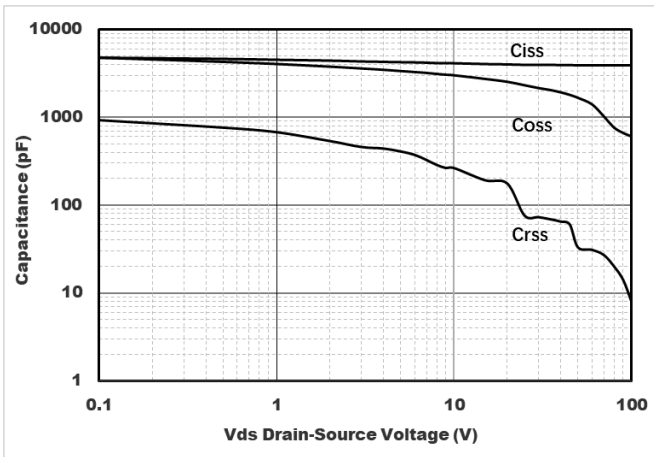

Figure3. Capacitance Characteristics

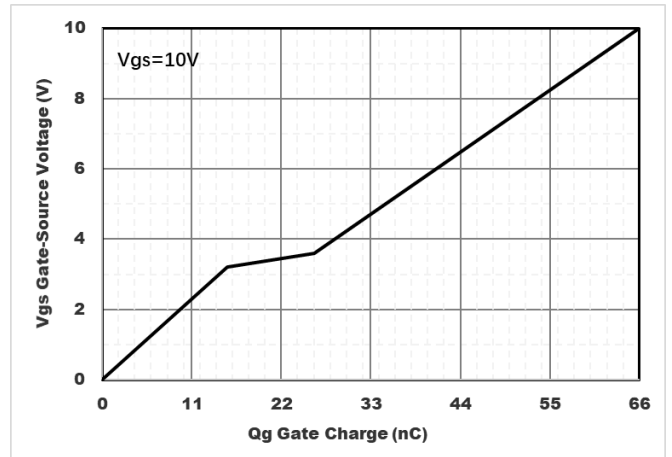

Figure4. Gate Charge

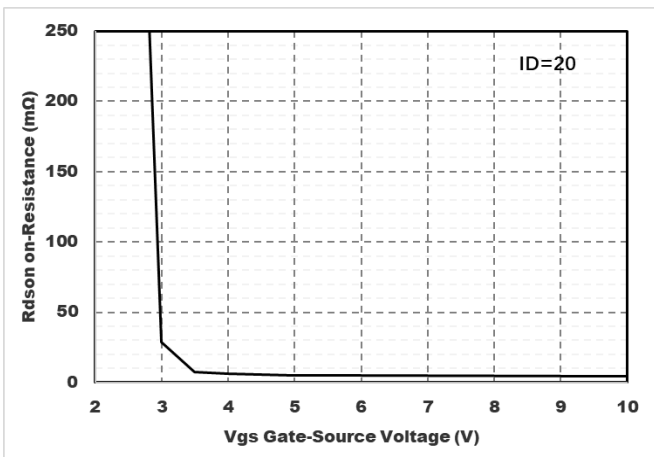

Figure5. : On-Resistance vs. Gate to Source Voltage

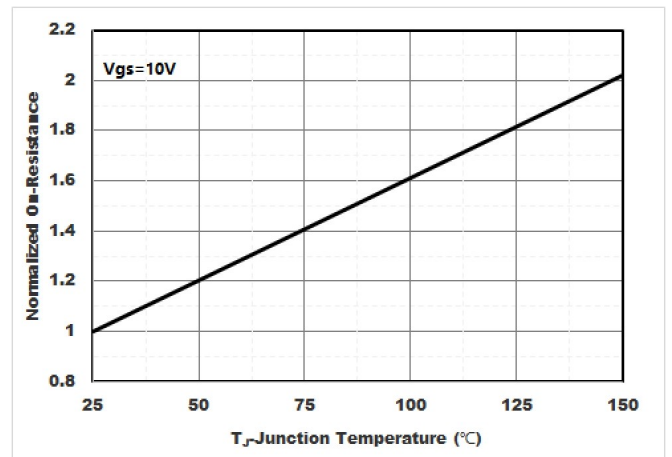

Figure6. Normalized On-Resistance



YJG90G10A

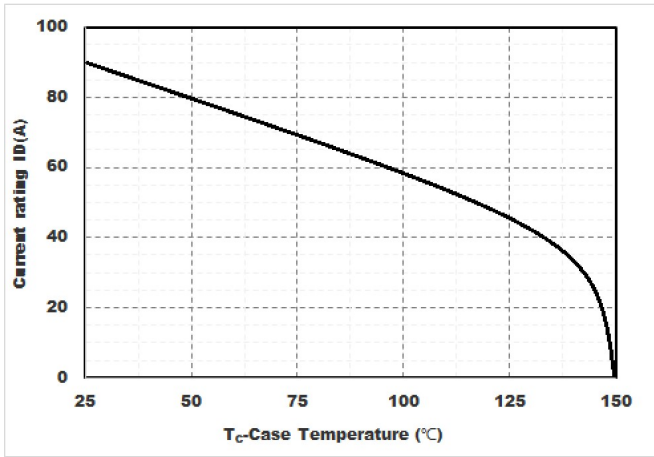

Figure7. Drain current

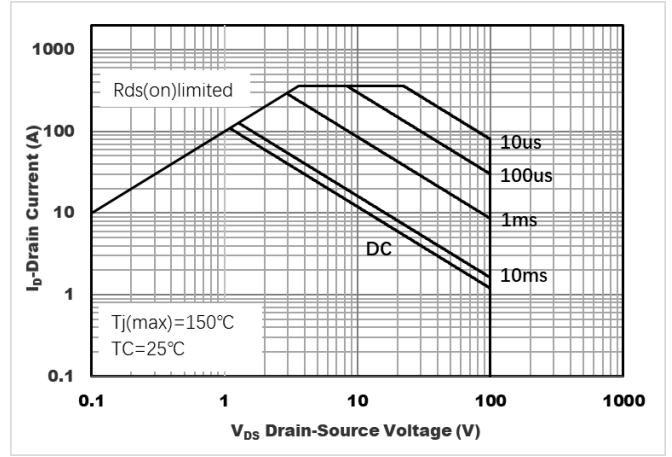

Figure8.Safe Operation Area

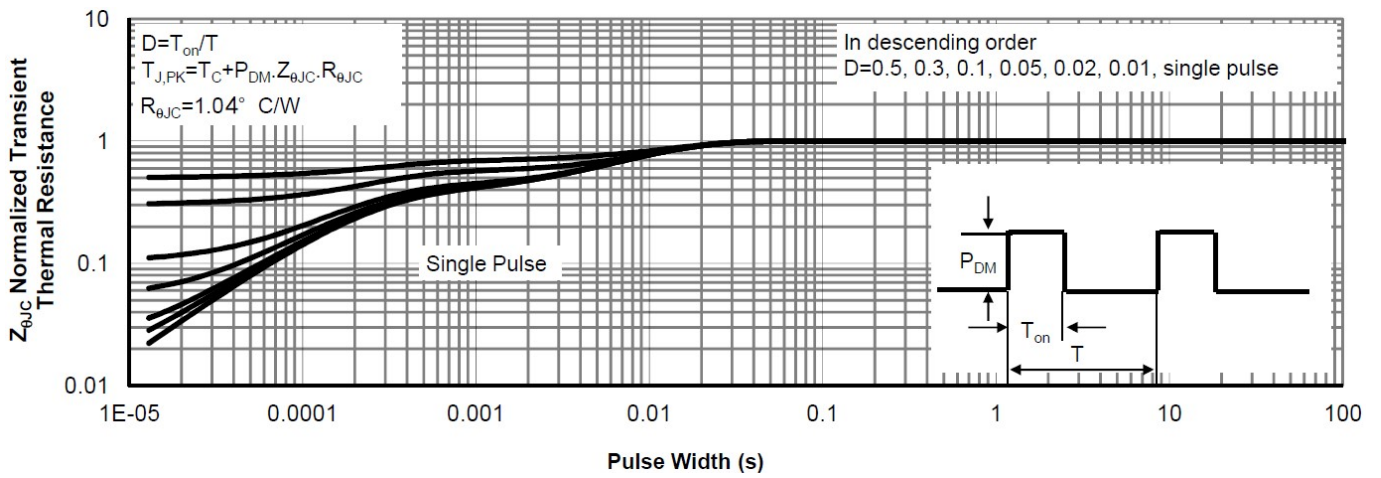
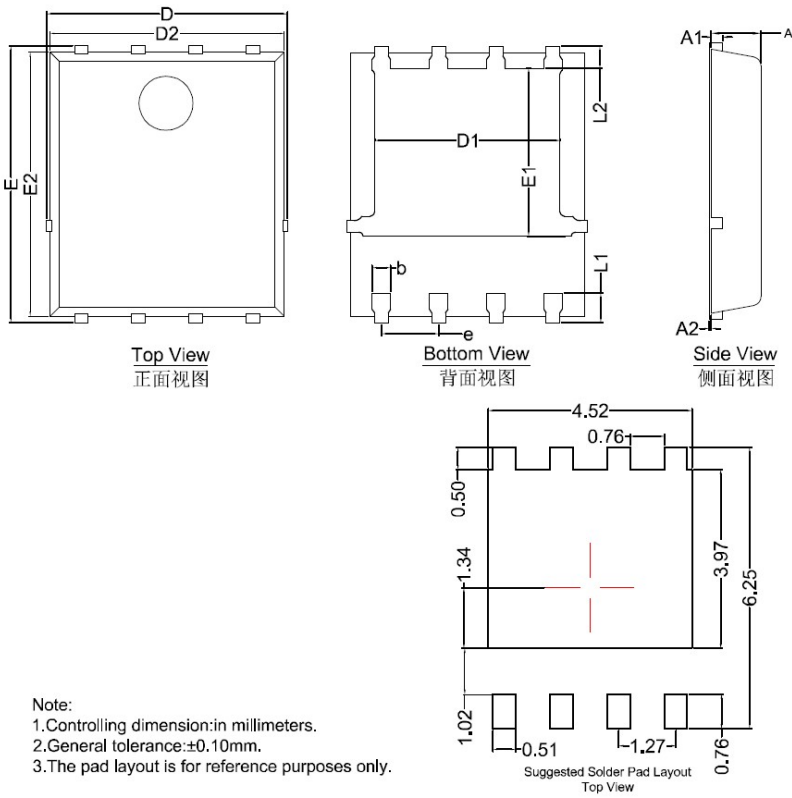

Figure9.Normalized Maximum Transient thermal impedance



YJG90G10A

■ PDFN5x6 Package information



SYMBOL	MILLIMETER		
	MIN	NOM	MAX
D	5.15	5.35	5.55
E	5.95	6.15	6.35
A	1.00	1.10	1.20
A1	0.254 BSC		
A2			0.10
D1	3.92	4.12	4.32
E1	3.52	3.72	3.92
D2	5.00	5.20	5.40
E2	5.66	5.86	6.06
L1	0.56	0.66	0.76
L2	0.50 BSC		
b	0.31	0.41	0.51
e	1.27 BSC		

Note:
 1. Controlling dimension: in millimeters.
 2. General tolerance: ± 0.10 mm.
 3. The pad layout is for reference purposes only.



YJG90G10A

Disclaimer

The information presented in this document is for reference only. Yangzhou Yangjie Electronic Technology Co., Ltd. reserves the right to make changes without notice for the specification of the products displayed herein to improve reliability, function or design or otherwise.

The product listed herein is designed to be used with ordinary electronic equipment or devices, and not designed to be used with equipment or devices which require high level of reliability and the malfunction of which would directly endanger human life (such as medical instruments, transportation equipment, aerospace machinery, nuclear-reactor controllers, fuel controllers and other safety devices), Yangjie or anyone on its behalf, assumes no responsibility or liability for any damages resulting from such improper use of sale.

This publication supersedes & replaces all information previously supplied. For additional information, please visit our website [http:// www.21yangjie.com](http://www.21yangjie.com) , or consult your nearest Yangjie's sales office for further assistance.