



# UF3A THRU UF3M

## 3.0AMP Surface Mount Glass Ultra Fast Rectifiers

### Features

- Low Power Loss, High Efficiency
- Ideally Suited for Automatic Assembly
- Guard Ring Die Construction
- Plastic Case Material has UL Flammability Classification Rating 94V- 0

### Mechanical Data

- Case: Molded plastic SMB
- Terminals: Plated leads solderable per MIL-STD-750, Method 2026 guaranteed
- Polarity: Color band denotes cathode end
- Mounting Position: Any
- Making: Type Number

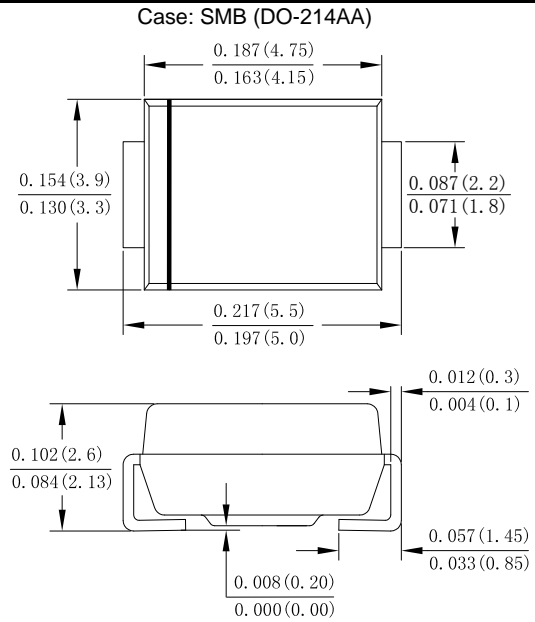

Dimensions in inches and (millimeters)

### Maximum Ratings and Electrical Characteristics

Rating at 25°C ambient temperature unless otherwise specified  
 Single phase, half wave, 60Hz, resistive or inductive load  
 For capacitive load derate current by 20%

Type Number	SYMBOL	UF3A	UF3B	UF3D	UF3G	UF3J	UF3K	UF3M	Unit
Maximum Recurrent Peak Reverse Voltage	$V_{RRM}$	50	100	200	400	600	800	1000	V
Maximum RMS Voltage	$V_{RMS}$	35	70	140	280	420	560	700	V
Maximum DC Blocking Voltage	$V_{DC}$	50	100	200	400	600	800	1000	V
Average Rectified Output Current @ $T_L = 50^\circ C$	$I_{F(AV)}$	3.0							A
Non-Repetitive Peak Forward Surge Current 8.3ms Single half sine-wave @ $T_j = 125^\circ C$ Superimposed On Rated Load (JEDEC Method)	$I_{FSM}$	80							A
Non-Repetitive Peak Forward Surge Current 1.0ms Single half sine-wave @ $T_j = 125^\circ C$ Superimposed On Rated Load (JEDEC Method)	$I_{FSM}$	160							A
10000 times of the wave surge current (time width 1ms, time interval 3s)	$I_{FSM}$	60							A
$I^2t$ Rating for Fusing (t < 8.3ms)	$I^2t$	26.56							A <sup>2</sup> s
Forward Voltage @ $I_F = 3.0A$	$V_{FM}$	1.0		1.3		1.7			V
Peak Reverse Current @ $T_A = 25^\circ C$	$I_R$	3.0							uA
At Rated DC Blocking Voltage @ $T_A = 125^\circ C$		100							
Maximum Reverse Recovery Time (Note 1)	$T_{rr}$	50				75			ns
Typical Junction Capacitance (Note 2)	$C_J$	50				20			pF
Typical Thermal Resistance (Note 3)	$R_{\theta JA}$	95							°C/W
Operating and Storage Temperature Range	$T_J, T_{STG}$	-55 to +175							°C

Note:

1. Reverse Recovery Test Conditions:  $I_F = 0.5A, I_R = 1.0A, I_{RR} = 0.25A$ .
2. Measured at 1.0 MHz and Applied reverse Voltage of 4.0V D.C
3. Device mounted on FR-4 substrate, 1" x 1", 2oz, single-sided, PC boards with 0.1" x 0.15" copper pad.



# UF3A THRU UF3M

## 3.0AMP Surface Mount Glass Ultra Fast Rectifiers

FIG.1 MAXIMUM AVERAGE FORWARD CURRENT DERATING

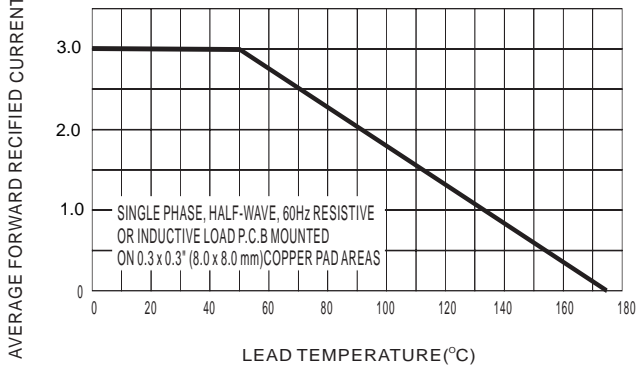

FIG.2 TYPICAL FORWARD CHARACTERISTICS

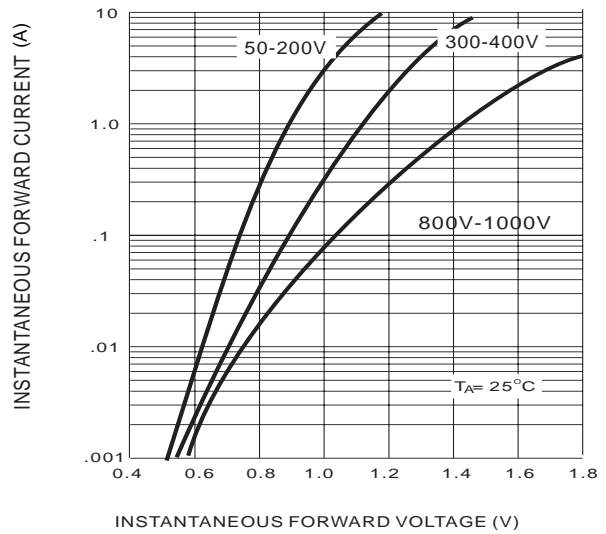

FIG.3 MAXIMUM NON-REPEITIVE SURGE CURRENT

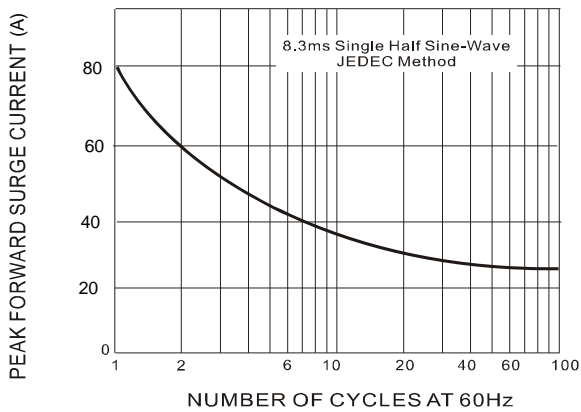

FIG.4 TYPICAL JUNCTION CAPACITANCE

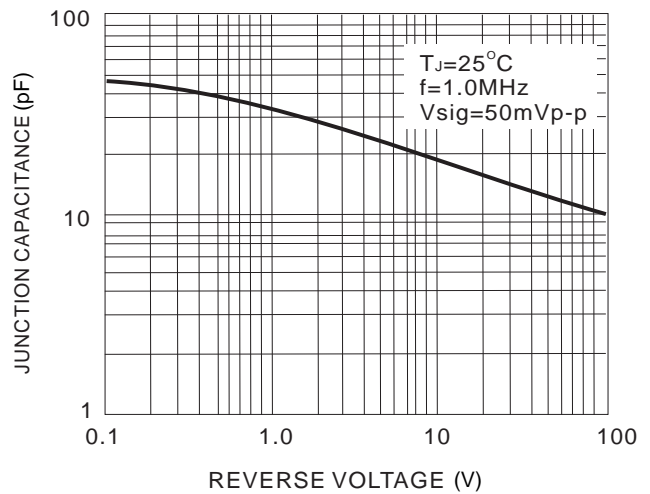

FIG.5 TYPICAL REVERSE CHARACTERISTICS

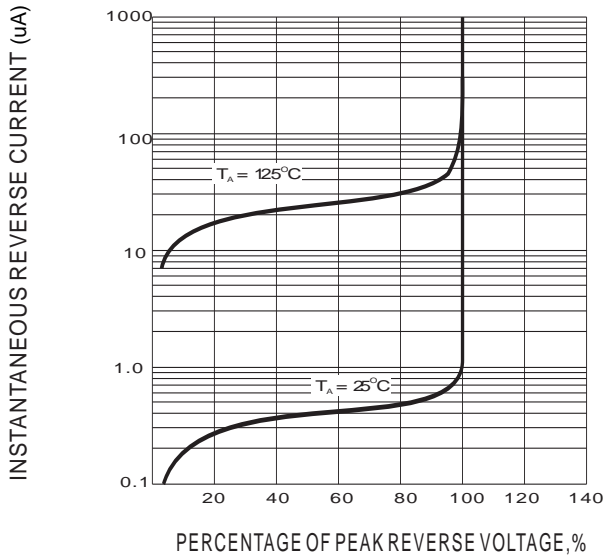
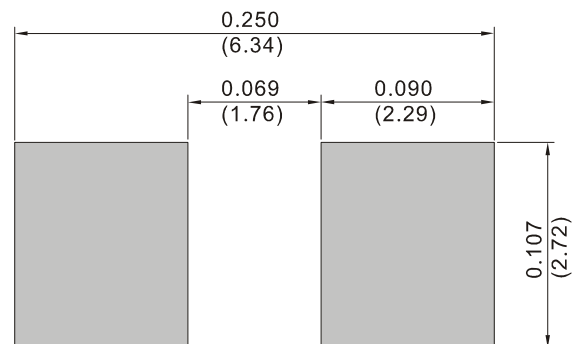

FIG.6 MOUNTING PAD LAYOUT





### Important Notice and Disclaimer

- Reproducing and modifying information of the document is prohibited without permission from XINNUO
- XINNUO reserves the right to make changes to this document and its products and specifications
- XINNUO disclaims any and all liability arising out of the application or use of any product including damages incidentally and consequentially occurred.
- XINNUO does not assume any and all implied warranties, including warranties of fitness for particular purpose, non-infringement and merchantability.
- Applications shown on the here in document are examples of standard use and operation. Customers are responsible in comprehending the suitable use in particular applications.  
XINNUO makes no representation or warranty that such applications will be suitable for the specified use without further testing or modification.
- The products shown here in are not designed and authorized for equipments requiring high level of reliability or relating to human life and for any applications concerning life-saving or life-sustaining, such as medical instruments, transportation equipment, aerospace machinery et cetera. Customers using or selling these products for use in such applications do so at their own risk and agree to fully indemnify XINNUO for any damages resulting from such improper use or sale.
- Since XINNUO uses lot number as the tracking base, please provide the lot number for tracking when complaining.