

DESCRIPTION

ST13P10 is the P-Channel logic enhancement mode power field effect transistor which is produced using high cell density, DMOS trench technology. The ST13P10 has been designed specially to improve the overall efficiency of DC/DC converters using either synchronous or conventional switching PWM controllers. It has been optimized for low gate charge, low $R_{DS(ON)}$ and fast switching speed.

PIN CONFIGURATION (D-PAK)

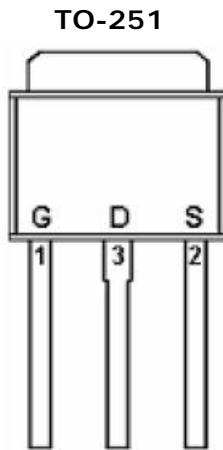
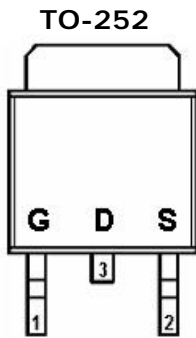

FEATURE

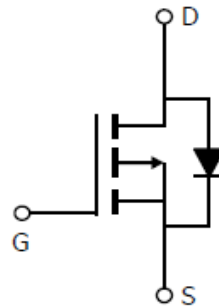
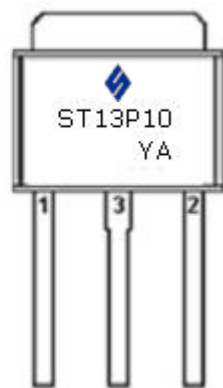

- I -100V/-13.0A, $R_{DS(ON)} = 130m\Omega$
@ $V_{GS} = -10V$
- I Super high density cell design for extremely low $R_{DS(ON)}$
- I Exceptional on-resistance and maximum DC current capability
- I TO-252,TO-251 package design

PART MARKING



Y: Year Code A: Process Code



ST13P10  
P Channel Enhancement Mode MOSFET

-13.0A

ABSOLUTE MAXIMUM RATINGS (Ta = 25°C Unless otherwise noted)

Parameter	Symbol	Typical	Unit
Drain-Source Voltage	VDSS	-100	V
Gate-Source Voltage	VGSS	±20	V
Continuous Drain Current (TJ=150°C)	ID	-13.0 -8.2	A
Pulsed Drain Current	IDM	-52	A
Continuous Source Current (Diode Conduction)	IS	-13	A
Power Dissipation	PD	66	W
Operation Junction Temperature	TJ	150	°C
Storage Temperature Range	TSTG	-55/150	°C
Thermal Resistance-Junction to Ambient	RθJA	110	°C/W



ST13P10



P Channel Enhancement Mode MOSFET

-13.0A

ELECTRICAL CHARACTERISTICS (Ta = 25°C Unless otherwise noted)

Parameter	Symbol	Condition	Min	Typ	Max	Unit
Static						
Drain-Source Breakdown Voltage	$V_{(BR)DSS}$	$V_{GS}=0V, I_D=-250\mu A$	-100			V
Gate Threshold Voltage	$V_{GS(th)}$	$V_{DS}=V_{GS}, I_D=-250\mu A$	-2.0		-4.0	V
Gate Leakage Current	I_{GSS}	$V_{DS}=0V, V_{GS}=\pm 20V$			± 100	nA
Zero Gate Voltage Drain Current	I_{DSS}	$V_{DS}=-100V, V_{GS}=0V$			-25	uA
		$V_{DS}=-80V, V_{GS}=0V$ $T_J=150^\circ C$			-250	
On-State Drain Current	$I_{D(on)}$	$V_{DS}\geq -10V, V_{DS}=-5V$	-52			A
Drain-source On-Resistance	$R_{DS(on)}$	$V_{GS}=-10V, I_D=-13A$		115	130	mΩ
Forward Transconductance	g_{fs}	$V_{DS}=-50V, I_D=-7.8A$	3.2			S
Diode Forward Voltage	V_{SD}	$I_S=-7.8A, V_{GS}=0V$			-1.6	V
Dynamic						
Total Gate Charge	Q_g	$V_{DS}=-80V, V_{GS}=-10V$ $I_D=-8.4A$			58	nC
Gate-Source Charge	Q_{gs}				8.3	
Gate-Drain Charge	Q_{gd}				32	
Input Capacitance	C_{iss}	$V_{DS}=-25V, V_{GS}=0V$ $F=1MHz$		760		pF
Output Capacitance	C_{oss}			260		
Reverse Transfer Capacitance	C_{rss}			170		
Turn-On Time	$t_{d(on)}$	$V_{GS}=-10V, V_{DD}=-50V$ $R_D=6.2\Omega, R_G=9.1\Omega$		15		nS
	t_r			58		
Turn-Off Time	$t_{d(off)}$			45		
	t_f			46		

STANSON TECHNOLOGY
 120 Bentley Square, Mountain View, Ca 94040 USA
www.stansontech.com

Copyright © 2009, Stanson Corp.
 ST13P10 2009. V1

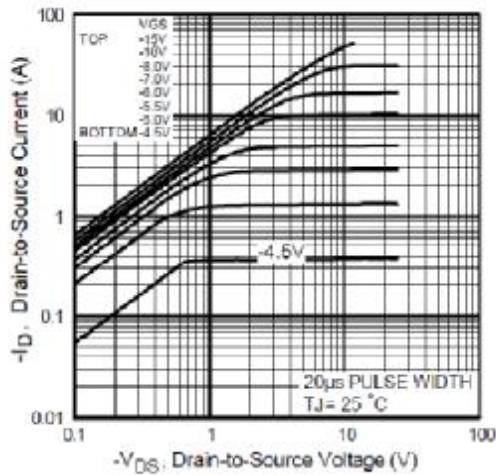
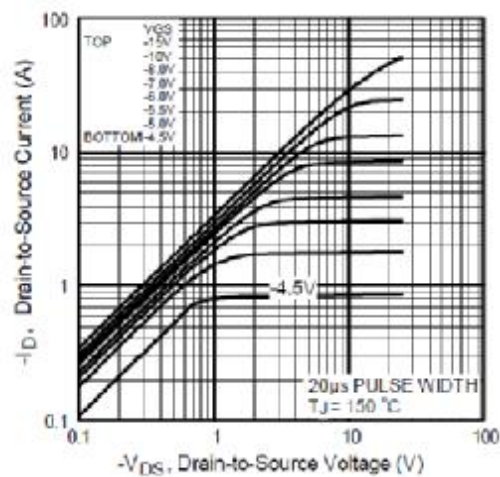
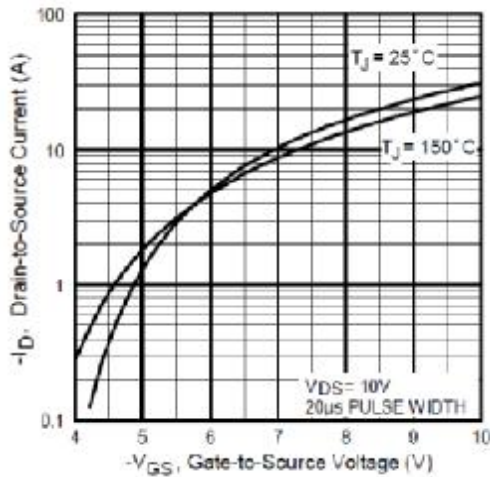
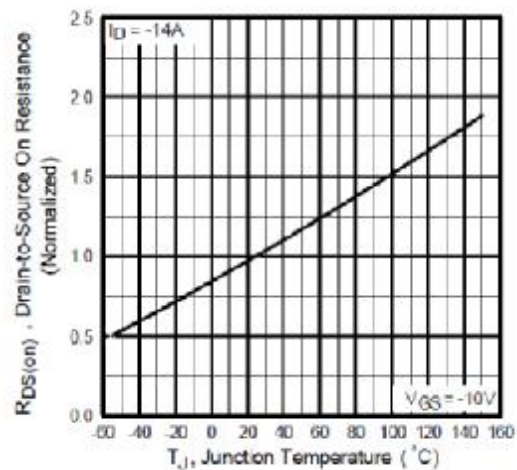
TYPICAL CHARACTERISTICS

Fig 1. Typical Output Characteristics

Fig 2. Typical Output Characteristics

Fig 3. Typical Transfer Characteristics

Fig 4. Normalized On-Resistance Vs. Temperature

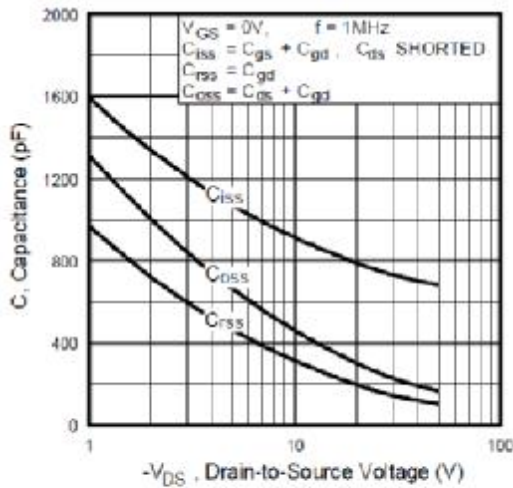

Fig 5. Typical Capacitance Vs. Drain-to-Source Voltage

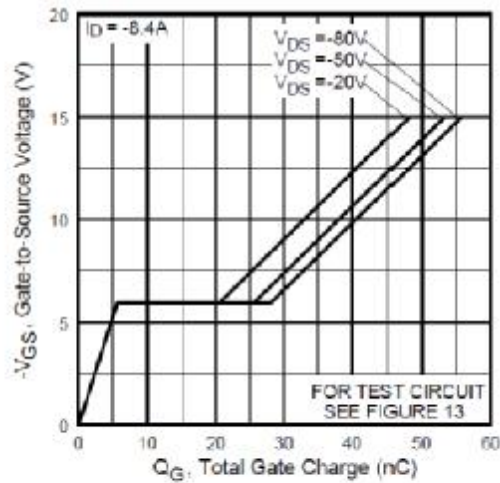
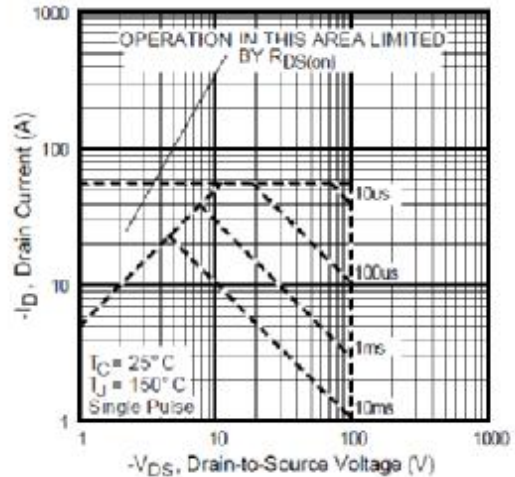
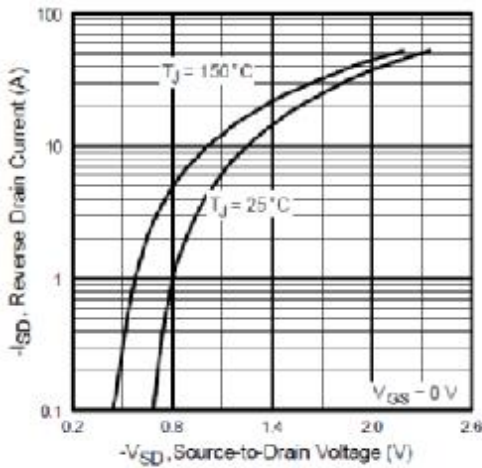

Fig 6. Typical Gate Charge Vs. Gate-to-Source Voltage



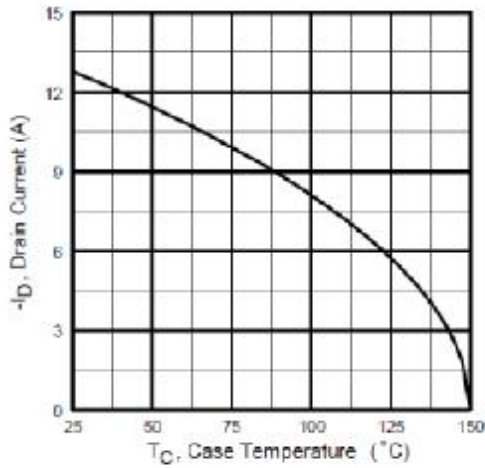

Fig 9. Maximum Drain Current Vs. Case Temperature

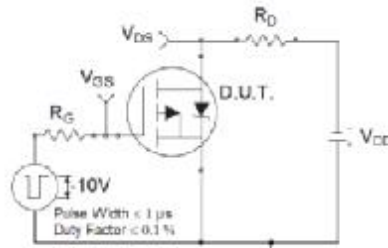

Fig 10a. Switching Time Test Circuit

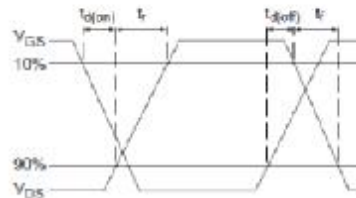

Fig 10b. Switching Time Waveforms

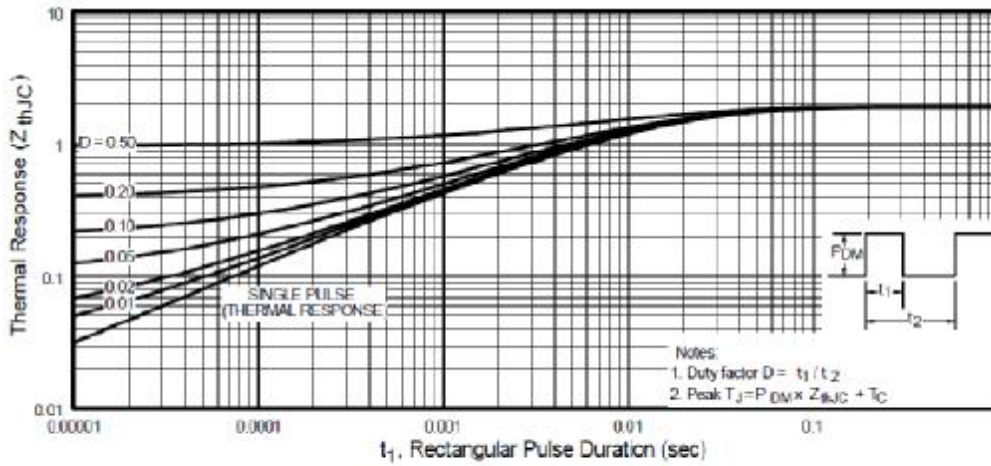
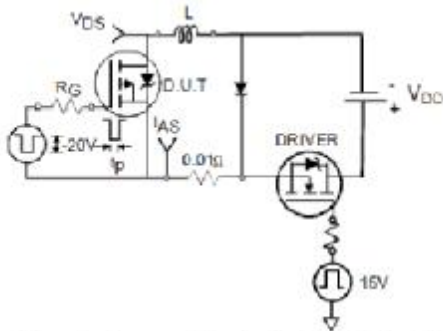
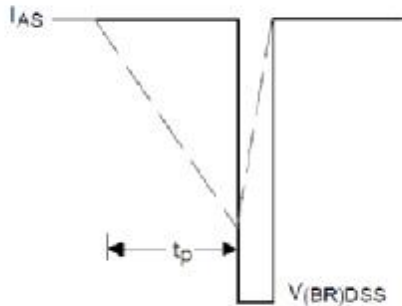
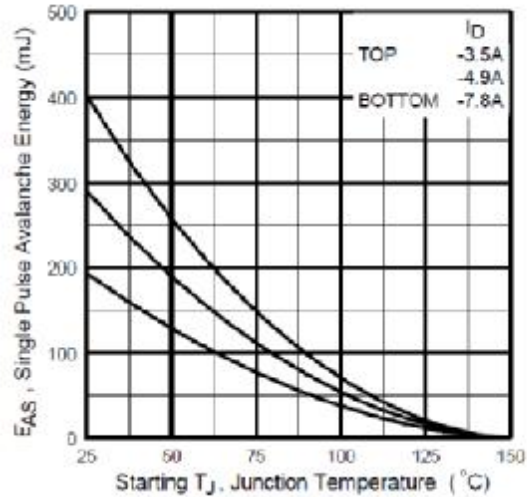
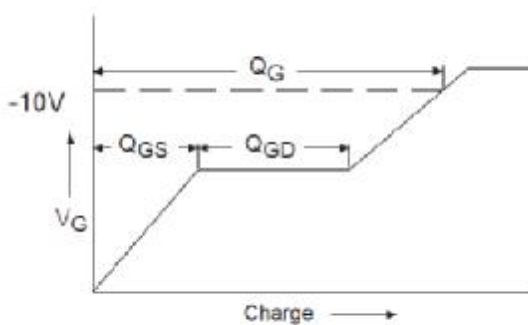
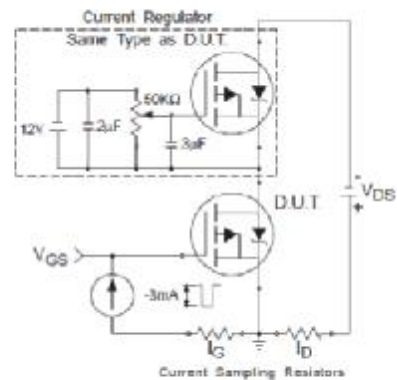
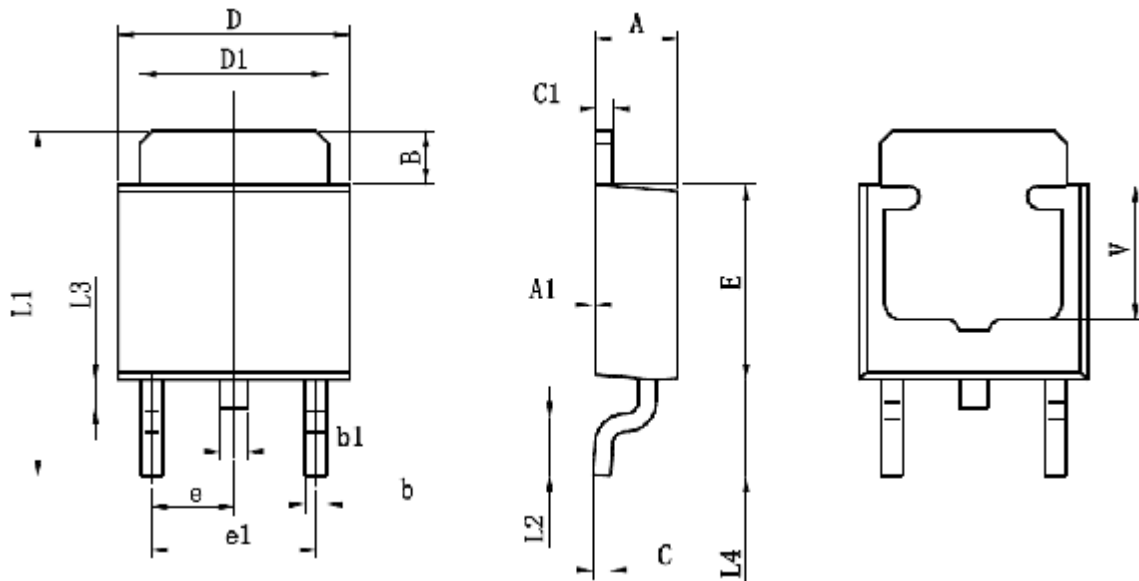
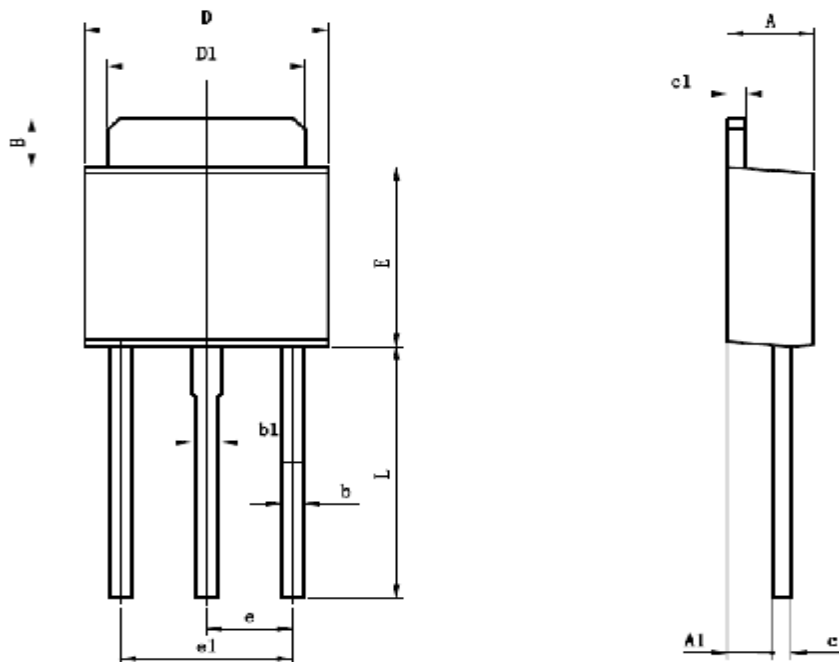

Fig 11. Maximum Effective Transient Thermal Impedance, Junction-to-Case

Fig 12a. Unclamped Inductive Test Circuit

Fig 12b. Unclamped Inductive Waveforms

Fig 12c. Maximum Avalanche Energy Vs. Drain Current

Fig 13a. Basic Gate Charge Waveform

Fig 13b. Gate Charge Test Circuit

TO-252-2L PACKAGE OUTLINE SOP-8P

Symbol	Dimensions In Millimeters		Dimensions In Inches	
	Min	Max	Min	Max
A	2.200	2.400	0.087	0.094
A1	0.000	0.127	0.000	0.005
B	1.350	1.650	0.053	0.065
b	0.500	0.700	0.020	0.028
b1	0.700	0.900	0.028	0.035
c	0.430	0.580	0.017	0.023
c1	0.430	0.580	0.017	0.023
D	6.350	6.650	0.250	0.262
D1	5.200	5.400	0.205	0.213
E	5.400	5.700	0.213	0.224
e	2.300TYP		0.091TYP	
e1	4.500	4.700	0.177	0.185
L1	9.500	9.900	0.374	0.390
L2	1.400	1.780	0.055	0.070
L3	0.650	0.950	0.026	0.037
L4	2.550	2.900	0.100	0.114
V	3.80REF		0.150REF	

TO-251 PACKAGE OUTLINE SOP-8P

Symbol	Dimensions In Millimeters		Dimensions In Inches	
	Min	Max	Min	Max
A	2.200	2.400	0.087	0.094
A1	1.020	1.270	0.040	0.050
B	1.350	1.650	0.053	0.065
b	0.500	0.700	0.020	0.028
b1	0.700	0.900	0.028	0.035
c	0.430	0.580	0.017	0.023
c1	0.430	0.580	0.017	0.023
D	6.350	6.650	0.250	0.262
D1	5.200	5.400	0.205	0.213
E	5.400	5.700	0.213	0.224
e	2.300TYP		0.091TYP	
e1	4.500	4.700	0.177	0.185
L	7.500	7.900	0.295	0.311