

修订 REV	标记 MARK	修改摘要 REVISION DESCRIPTION	签名 SIGNATURE	日期 DATE
AO		NEW RELEASE	WANG	2012-12-10

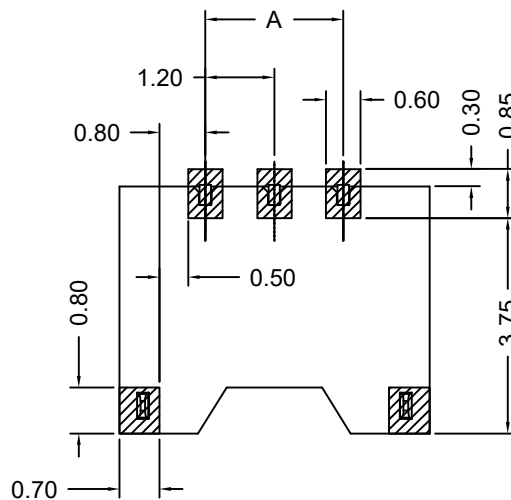

RECOMMENDED PCB LAYOUT
GENERAL TOLERANCE ±0.05

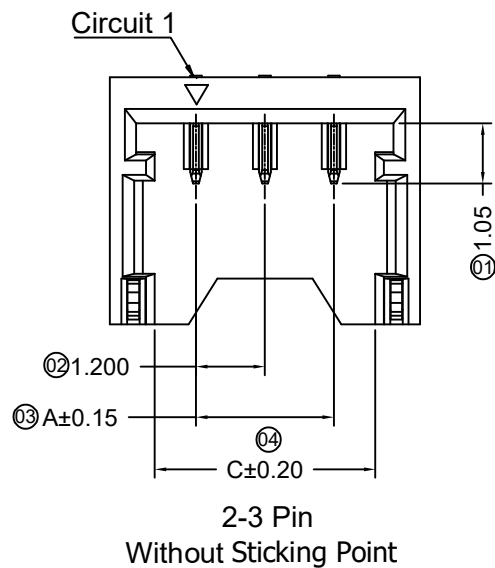
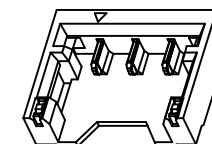
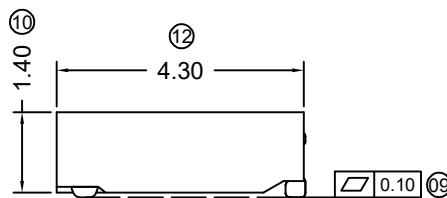
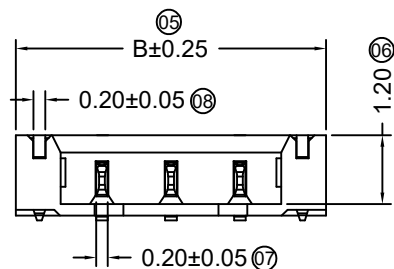

3D View

■ Specification

- Voltage Rating : 50V AC/DC
- Current Rating : 2A AC/DC
- Withstanding Voltage : 500V AC /minute
- Insulation Resistance : ≥100MΩ min
- Temperature Range : -40°C to + 105°C
- Contact Resistance : ≤20mΩ
- After Environmental Testing: ≤40mΩ
- Suitable Wire/Cable:AWG #28 to #30,OD:0.8mm max

Poles	Dimensions(mm)			Poles	Dimensions(mm)		
	A	B	C		A	B	C
02	1.20	4.20	2.64	03	2.40	5.40	3.84



深圳市华德共创科技有限公司

Shenzhen Huade co-create Technology Co.,LTD

TEL : 0755-27129737 FAX : 0755-29940187

-TOLERANCES- UNLESS OTHERWISE SPECIFIED 公差参数表				 		TITLE: 产品名称 : MX1.2针座			
X.X	±0.30	X.X°	±3°	APPD: 核准 :	XIE	PART NO: 产品编号 : HDGC1202WR-S-XP			
X.XX	±0.30	X.XX°	±2°	CHECK: 校对 :	WANG	DATE	SCALE	UNIT	CODE NUMBER
X.XXX	±0.10	X.XXX°	±1°	DRAW: 绘图 :	WANG	2012-12-10	1:1	mm	A096

修订 REV	标记 MARK	修改摘要 REVISION DESCRIPTION	签名 SIGNATURE	日期 DATE
AO		NEW RELEASE	WANG	2012-12-10

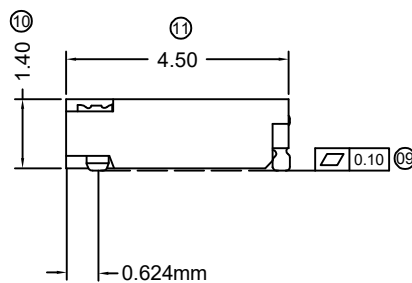
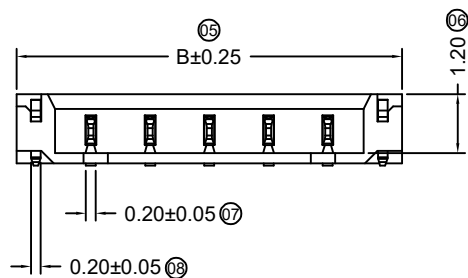
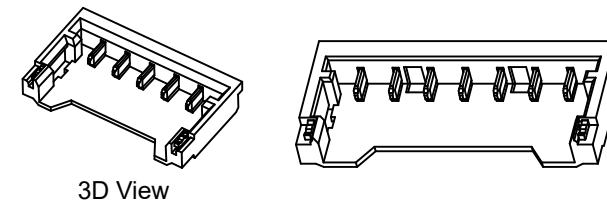
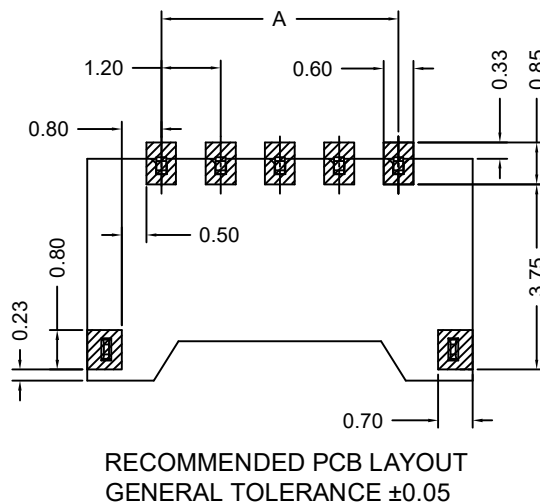
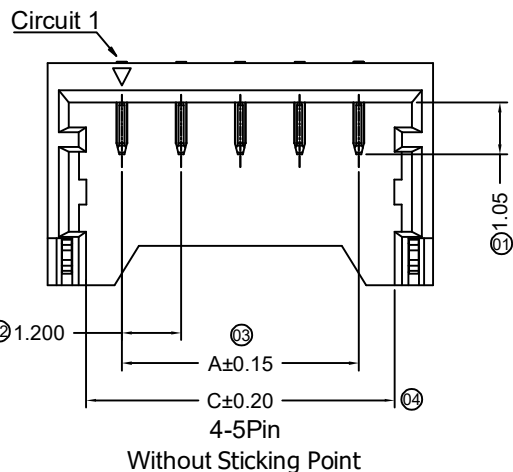

Specification

- Voltage Rating : 50V AC/DC
- Current Rating : 2A AC/DC
- Withstanding Voltage : 500V AC /minute
- Insulation Resistance : $\geq 100M\Omega$ min
- Temperature Range : 40°C to + 105°C
- Contact Resistance : $\leq 20m\Omega$
- After Environmental Testing: $\leq 40m\Omega$
- Suitable Wire/Cable: AWG #28 to #30, OD: 0.8mm max

Poles	Dimensions(mm)			Poles	Dimensions(mm)		
	A	B	C		A	B	C
04	3.60	6.60	5.04	08	8.40	11.40	9.84
05	4.80	7.80	6.24	09	9.60	12.60	11.04
06	6.00	9.00	7.44	10	10.80	13.80	12.24
07	7.20	10.20	8.64				

HDGC 深圳市华德共创科技有限公司
Shenzhen Huade co-create Technology Co., LTD
TEL : 0755-27129737 FAX : 0755-29940187

-TOLERANCES- UNLESS OTHERWISE SPECIFIED 公差参数表				TITLE: 产品名称: MX1.2针座	
X.X	± 0.30	X.X°	$\pm 3^\circ$	APPD: 核准:	XIE
X.XX	± 0.30	X.XX°	$\pm 2^\circ$	CHECK: 校对:	WANG
X.XXX	± 0.10	X.XXX°	$\pm 1^\circ$	DRAW: 绘图:	WANG
PART NO: 产品编号:		HDGC1202WR-S-XP			
DATE	SCALE	UNIT	CODE NUMBER		
2012-12-10	1:1	mm	A096		