

Description

The JSM3622 uses advanced trench technology to provide excellent $R_{DS(ON)}$, low gate charge and operation with gate voltages as low as 2.5V. This device is suitable for use as a Battery protection or in other switching application.

General Feature

- $V_{DS} = 30V, I_D = 25A$
- $R_{DS(ON) \text{ typ}} = 12m\Omega @ V_{GS} = 10V$
- $R_{DS(ON) \text{ typ}} = 16m\Omega @ V_{GS} = 4.5V$
- High Power and current handing capability
- Lead free product is acquired
- Surface mount package

Application

- Battery switch
- DC/DC converter

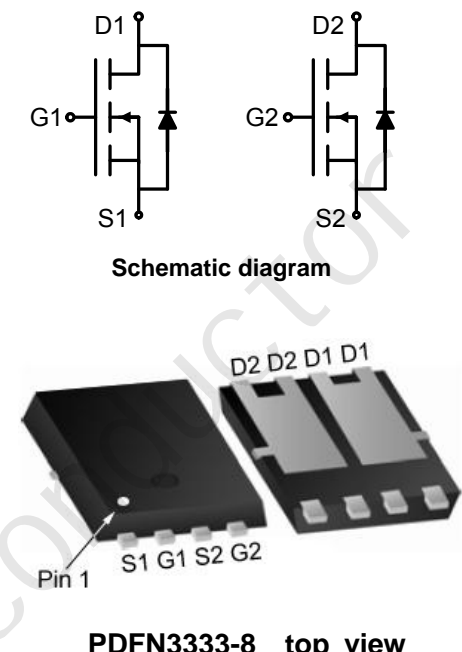

Schematic diagram

PDFN3333-8 top view

Absolute Maximum Ratings ($T_A = 25^\circ C$ unless otherwise noted)

Parameter	Symbol	Limit	Unit
Drain-Source Voltage	V_{DS}	30	V
Gate-Source Voltage	V_{GS}	± 20	V
Drain Current-Continuous	I_D	25	A
Drain Current-Pulsed ^(Note 1)	I_{DM}	75	A
Maximum Power Dissipation	P_D	3.5	W
Operating Junction and Storage Temperature Range	T_J, T_{STG}	-55 To 150	$^\circ C$

Thermal Characteristic

Thermal Resistance, Junction-to-Ambient ^(Note 2)	$R_{\theta JA}$	35	$^\circ C/W$
---	-----------------	----	--------------

Electrical Characteristics ($T_A = 25^\circ C$ unless otherwise noted)

Parameter	Symbol	Condition	Min	Typ	Max	Unit
Off Characteristics						
Drain-Source Breakdown Voltage	BV_{DSS}	$V_{GS} = 0V, I_D = 250\mu A$	30	-	-	V
Zero Gate Voltage Drain Current	I_{DSS}	$V_{DS} = 30V, V_{GS} = 0V$	-	-	1	μA

Parameter	Symbol	Condition	Min	Typ	Max	Unit
Gate-Body Leakage Current	I_{GSS}	$V_{GS}=\pm 20V, V_{DS}=0V$	-	-	± 100	nA
On Characteristics (Note 3)						
Gate Threshold Voltage	$V_{GS(th)}$	$V_{DS}=V_{GS}, I_D=250\mu A$	1.0	1.6	2.4	V
Drain-Source On-State Resistance	$R_{DS(ON)}$	$V_{GS}=10V, I_D=15A$		12	14	m Ω
		$V_{GS}=4.5V, I_D=10A$		16	18	m Ω
Dynamic Characteristics (Note 4)						
Input Capacitance	C_{iss}	$V_{DS}=15V, V_{GS}=0V,$ $F=1.0MHz$	-	564	-	PF
Output Capacitance	C_{oss}		-	75	-	PF
Reverse Transfer Capacitance	C_{rss}		-	66	-	PF
Switching Characteristics (Note 4)						
Turn-on Delay Time	$t_{d(on)}$	$V_{DD}=30V, I_D=1.5A$ $V_{GS}=10V, R_{GEN}=1\Omega$	-	9	-	nS
Turn-on Rise Time	t_r		-	10	-	nS
Turn-Off Delay Time	$t_{d(off)}$		-	15	-	nS
Turn-Off Fall Time	t_f		-	5	-	nS
Total Gate Charge	Q_g	$V_{DS}=30V, I_D=15A,$ $V_{GS}=10V$	-	14.2	-	nC
Gate-Source Charge	Q_{gs}		-	1.5	-	nC
Gate-Drain Charge	Q_{gd}		-	3.6	-	nC
Drain-Source Diode Characteristics						
Diode Forward Voltage (Note 3)	V_{SD}	$V_{GS}=0V, I_S=15A$			1.2	V
Diode Forward Current (Note 2)	I_S				25	A

Notes:

1. Repetitive Rating: Pulse width limited by maximum junction temperature.
2. Surface Mounted on FR4 Board, $t \leq 10$ sec.
3. Pulse Test: Pulse Width $\leq 300\mu s$, Duty Cycle $\leq 2\%$.
4. Guaranteed by design, not subject to production

Typical Electrical and Thermal Characteristics

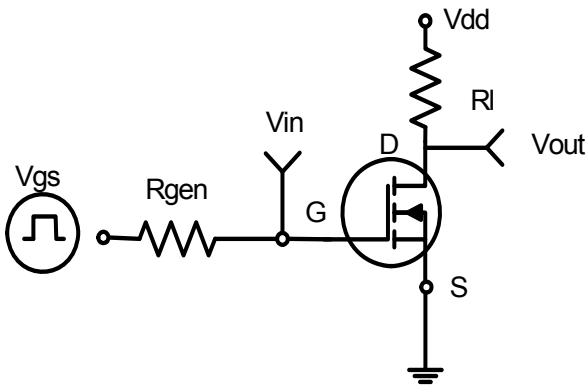

Figure 1 Switching Test Circuit

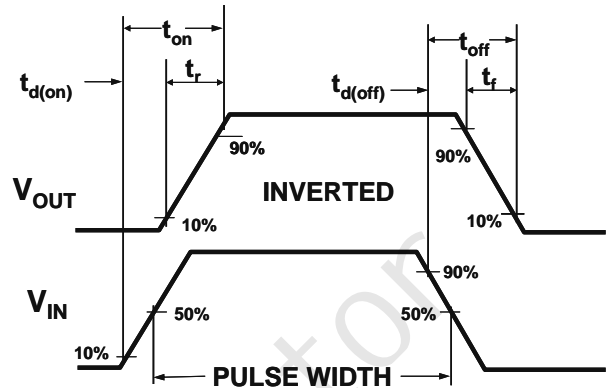

Figure 2 Switching Waveforms

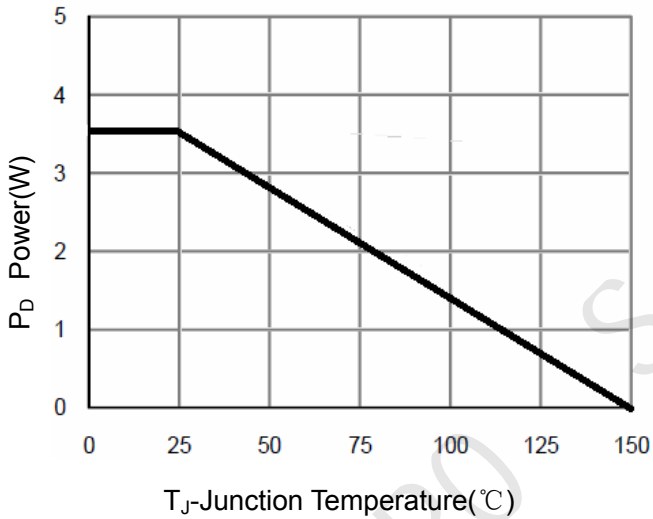

Figure 3 Power Dissipation

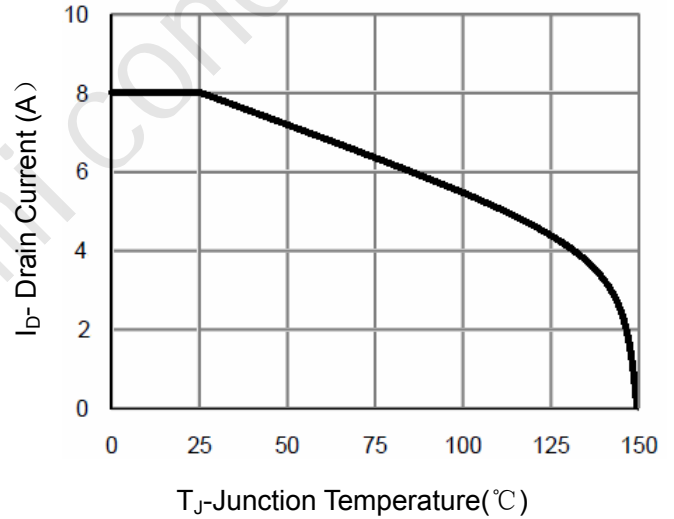

Figure 4 Drain Current

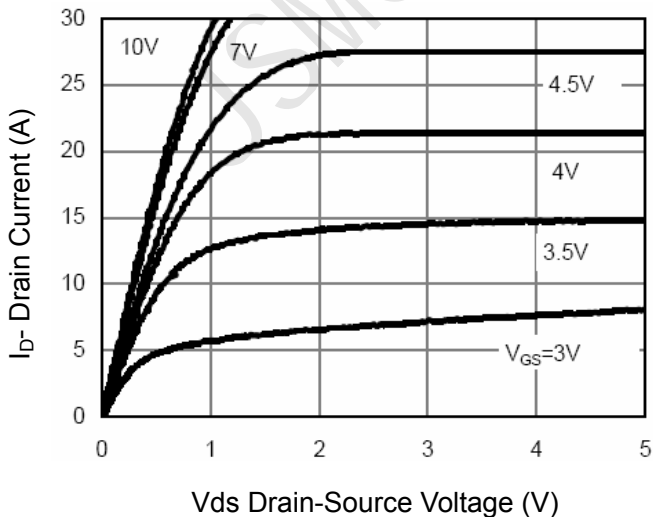

Figure 5 Output Characteristics

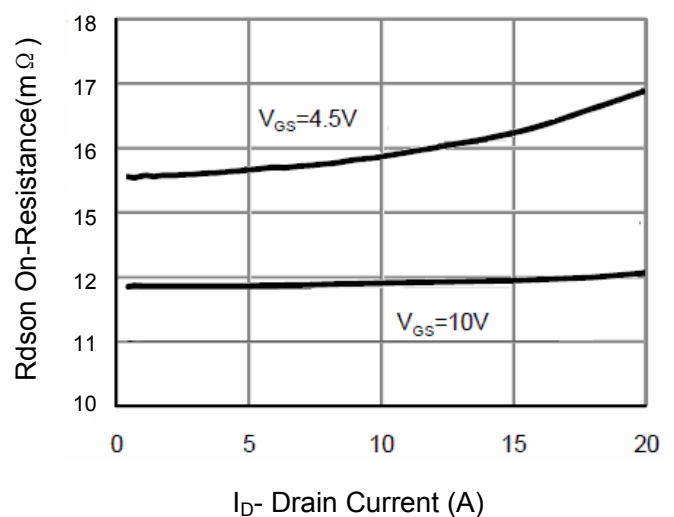
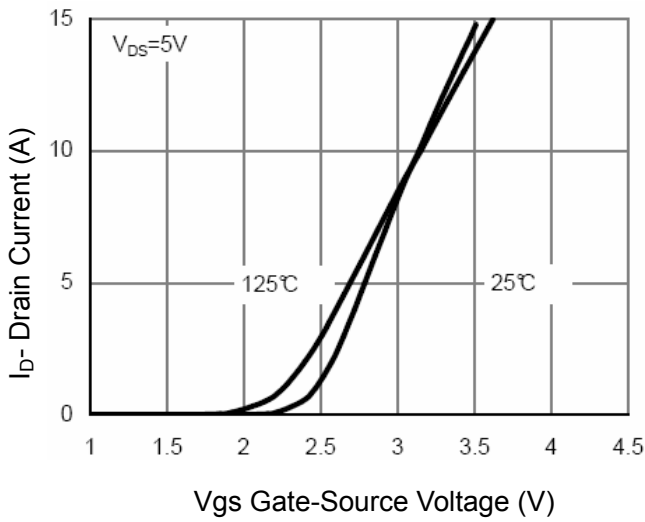
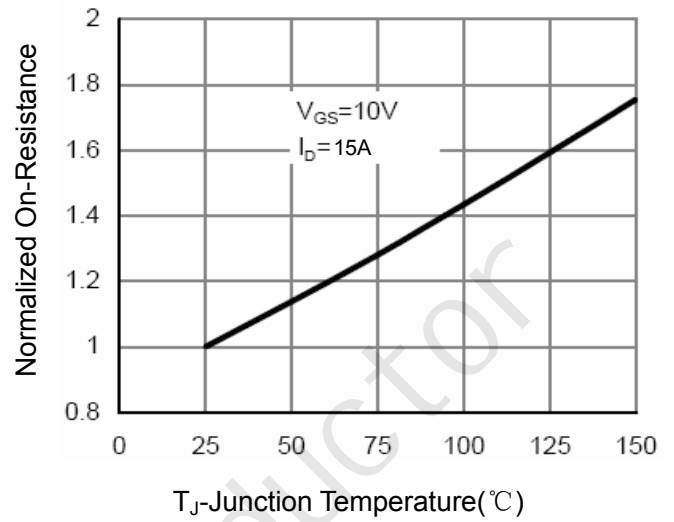
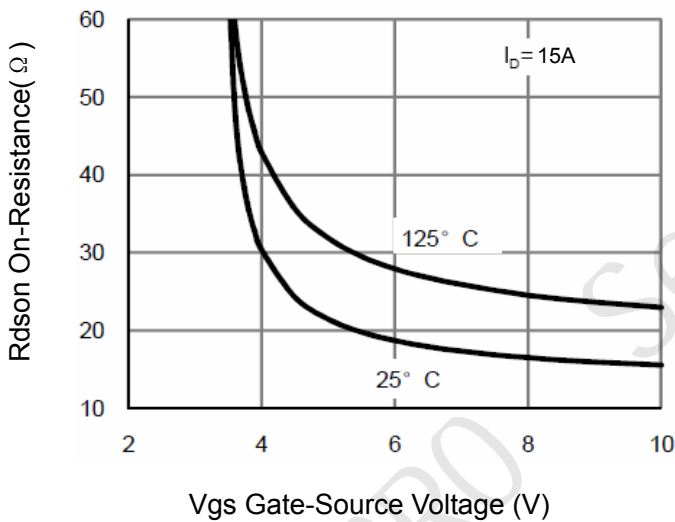
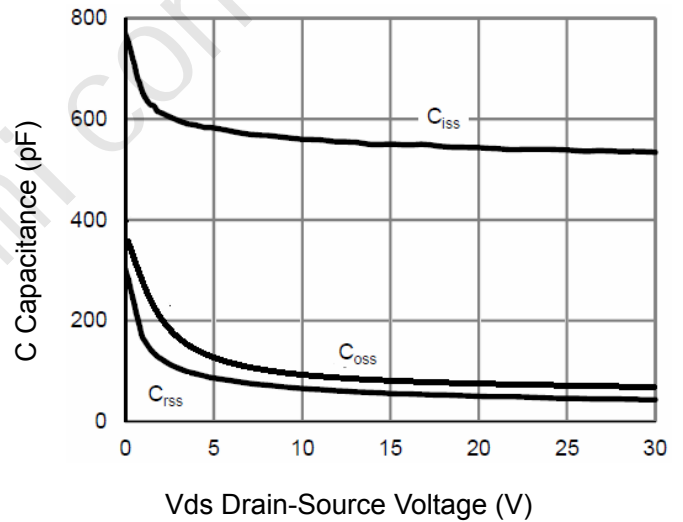
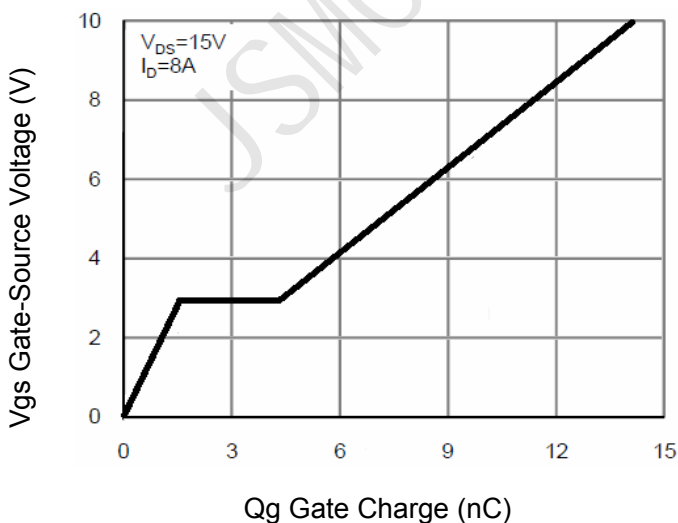
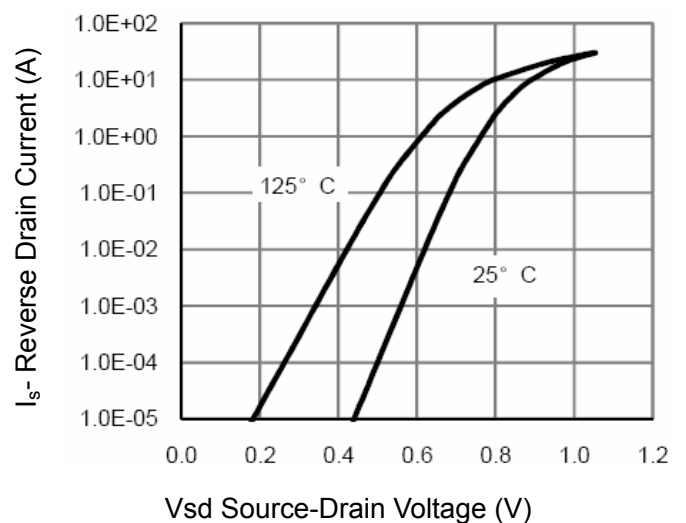

Figure 6 Drain-Source On-Resistance

Figure 7 Transfer Characteristics

Figure 8 Drain-Source On-Resistance

Figure 9 Rdson vs Vgs

Figure 10 Capacitance vs Vds

Figure 11 Gate Charge

Figure 12 Source- Drain Diode Forward

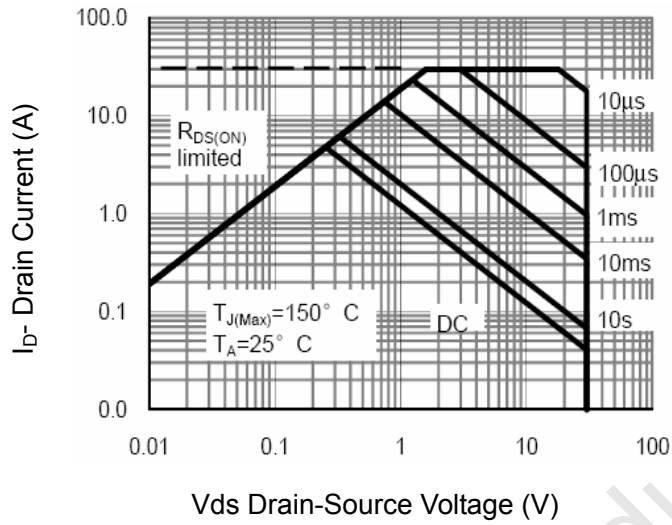

Figure 13 Safe Operation Area

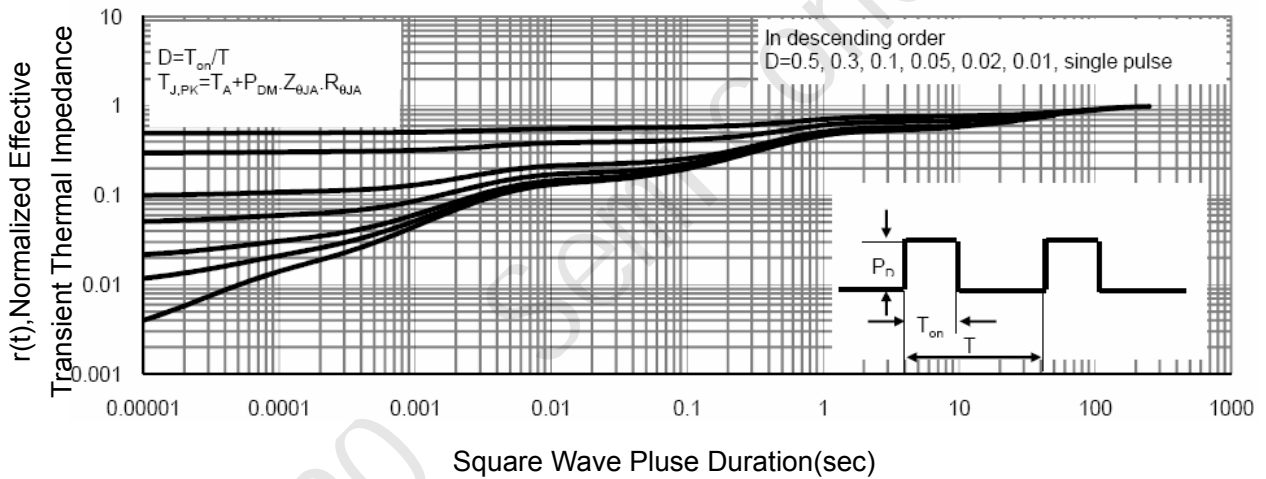
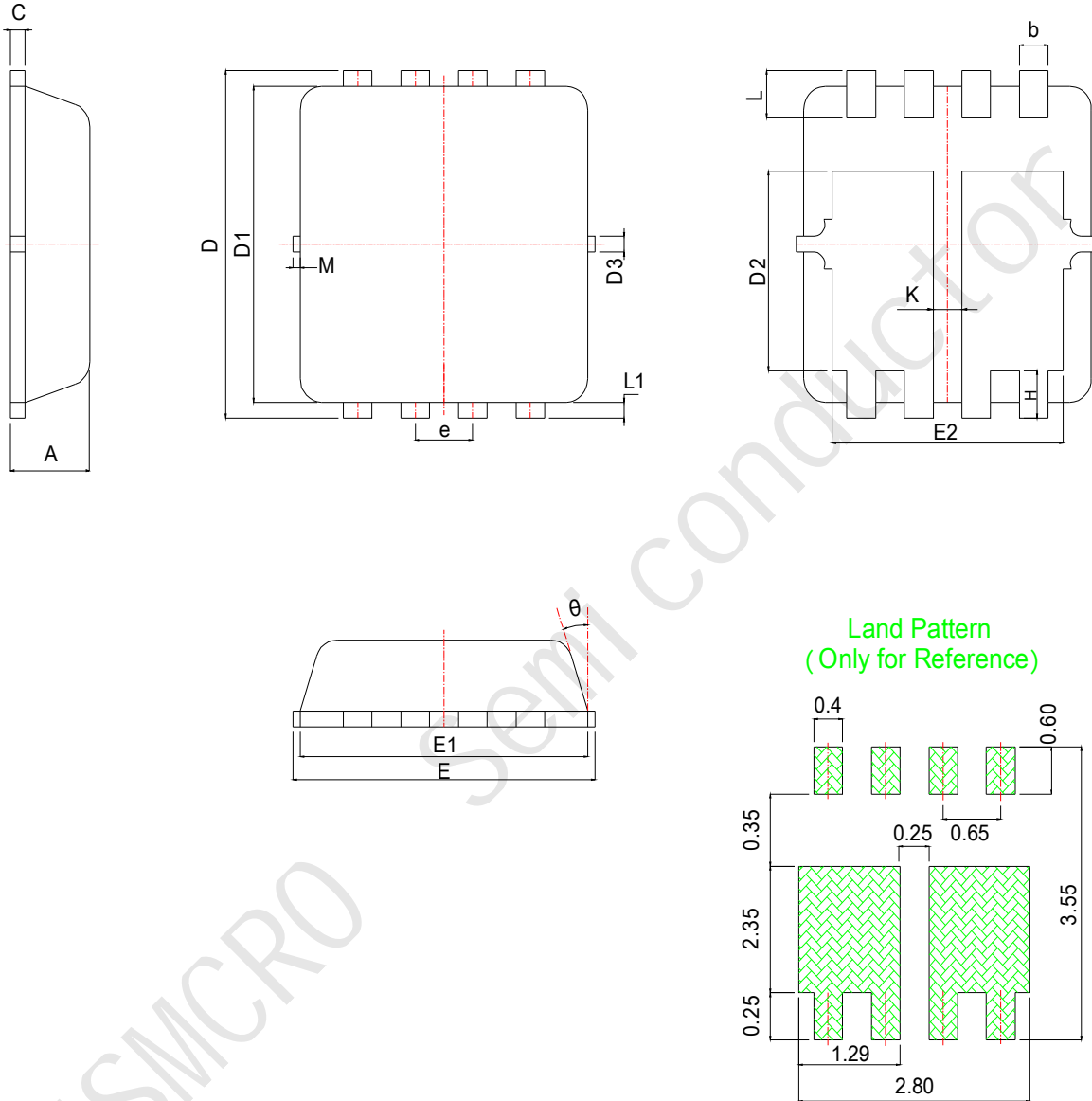

Figure 14 Normalized Maximum Transient Thermal Impedance

PDFN3333

SYMBOL	MM			INCH			SYMBOL	MM			INCH		
	MIN	NOM	MAX	MIN	NOM	MAX		MIN	NOM	MAX	MIN	NOM	MAX
A	0.70	0.75	0.80	0.028	0.030	0.031	E1	3.00	3.15	3.20	0.118	0.122	0.126
b	0.25	0.30	0.35	0.010	0.012	0.014	E2	2.39	2.49	2.59	0.094	0.098	0.102
c	0.10	0.15	0.25	0.004	0.007	0.010	e	0.65BSC			0.026BSC		
D	3.25	3.35	3.45	0.128	0.132	0.136	H	0.30	0.40	0.50	0.012	0.016	0.020
D1	3.00	3.10	3.20	0.118	0.122	0.126	L	0.30	0.40	0.50	0.012	0.016	0.020
D2	1.78	1.88	1.98	0.070	0.074	0.078	L1	*	0.13	*	*	0.005	*
D3	*	0.13	*	*	0.005	*	theta	*	10°	12°	*	10°	12°
E	3.20	3.30	3.40	0.126	0.130	0.134	M	*	*	0.15	*	*	0.006
K	0.30	*	*	0.012	*	*							