

FEATURES

- Integrated 80mΩ Power MOSFET
- 2.5V to 24V Input Voltage
- 1.2MHz Fixed Switching Frequency
- Internal 4A Switch Current Limit
- Adjustable Output Voltage
- Internal Compensation
- Up to 24V Output Voltage
- Automatic Pulse Frequency Modulation Mode at Light Loads
- up to 93% Efficiency
- Available in a 6-Pin SOT23-6 Package

APPLICATIONS

- Battery-Powered Equipment
- Set-Top Boxed
- LCD Bias Supply
- DSL and Cable Modems and Routers
- Networking cards powered from PCI or PCI express slots

GENERAL DESCRIPTION

The MT3608B is a constant frequency, 6-pin SOT23 current mode step-up converter intended for small, low power applications. The MT3608B switches at 1.2MHz and allows the use of tiny, low cost capacitors and inductors 2mm or less in height. Internal soft-start results in small inrush current and extends battery life.

The MT3608B features automatic shifting to pulse frequency modulation mode at light loads. The MT3608B includes under-voltage lockout, current limiting, and thermal overload protection to prevent damage in the event of an output overload. The MT3608B is available in a small 6-pin SOT-23 package.

TYPICAL APPLICATION

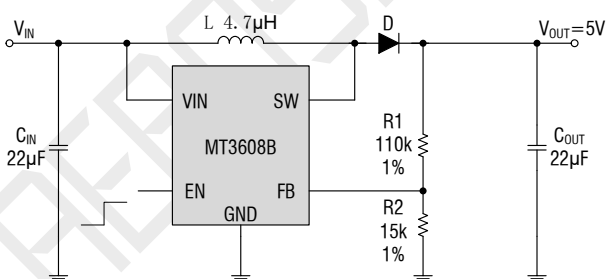
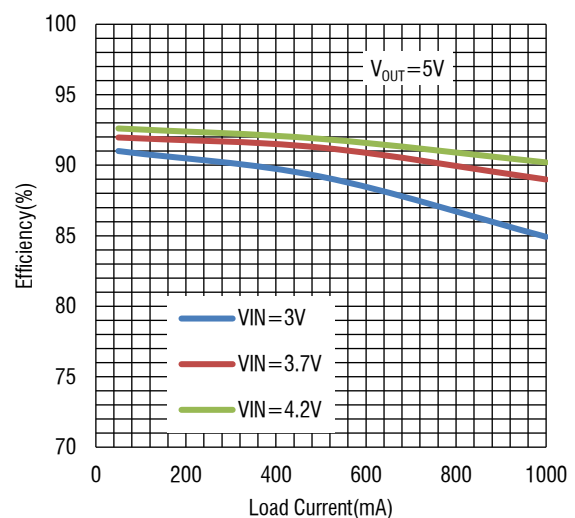

Figure 1. Basic Application Circuit



ABSOLUTE MAXIMUM RATINGS (Note 1)

VIN,EN voltages.....	-0.3V to 26V	Junction Temperature(Note2).....	160°C
FB Voltages.....	-0.3V to 6V	Operating Temperature Range.....	-40°C to 85°C
SW Voltage.....	-0.3V to 30V	Lead Temperature(Soldering,10s).....	300°C
Power Dissipation.....	0.6W	Storage Temperature Range.....	-65°C to 150°C
Thermal Resistance θ_{JC}	130°C/W	ESD HBM(Human Body Mode).....	2kV
Thermal Resistance θ_{JA}	250°C/W	ESD MM(Machine Mode).....	200V

PACKAGE/ORDER INFORMATION

<p>TOP VIEW</p> <p>SW 1 6 NC</p> <p>GND 2 5 VIN</p> <p>FB 3 4 EN</p> <p>6-LEAD PLASTIC SOT-23</p> <p>$T_{jmax} = 160^{\circ}C, \theta_{JA} = 250^{\circ}C/W, \theta_{JC} = 130^{\circ}C/W$</p>	Order Part Number	Package	Top Marking
	MT3608B	SOT23-6	B628DC

D: Year, C: Week

PIN DESCRIPTION

Pin Name	Pin Number	Description
SW	1	Power Switch Output. SW is the drain of the internal MOSFET switch. Connect the power inductor and output rectifier to SW. SW can swing between GND and 27V.
GND	2	Ground Pin
FB	3	Feedback Input. The FB voltage is 0.6V. Connect a resistor divider to FB.
EN	4	Regulator On/Off Control Input. A high input at EN turns on the converter, and a low input turns it off. When not used, connect EN to the input supply for automatic startup.
VIN	5	Input Supply Pin. Must be locally bypassed.
NC	6	No Connect

ELECTRICAL CHARACTERISTICS (Note 3)

($V_{IN}=V_{EN}=5V, T_A = 25^{\circ}C$, unless otherwise noted.)

PARAMETER	CONDITIONS	MIN	TYP	MAX	UNIT
Operating Input Voltage		2.5		24	V
Under Voltage Lockout				2.4	V
Under Voltage Lockout Hysteresis			100		mV
Current (Shutdown)	$V_{EN} = 0V$		0.1	1	μA
Quiescent Current (PFM)	$V_{FB}=0.7V$, No switch		70	150	μA
Quiescent Current (PWM)	$V_{FB}=0.5V$, switch		1.0	2.0	mA
Switching Frequency			1.2		MHz
Maximum Duty Cycle	$V_{FB} = 0V$	90			%
EN Input High Voltage		1.5			V
EN Input Low Voltage				0.4	V
FB Voltage		0.588	0.6	0.612	V
SW On Resistance			80	150	m Ω
SW Current Limit	$V_{IN} = 5V$, Duty cycle=50%		4		A
SW Leakage	$V_{SW} = 20V$			1	μA
Thermal Shutdown			155		$^{\circ}C$

Note 1: Absolute Maximum Ratings are those values beyond which the life of a device may be impaired.

Note 2: T_J is calculated from the ambient temperature T_A and power dissipation P_D according to the following formula: $T_J = T_A + (P_D) \times (250^{\circ}C/W)$.

Note 3: 100% production test at $25^{\circ}C$. Specifications over the temperature range are guaranteed by design and characterization.

TYPICAL PERFORMANCE CHARACTERISTICS

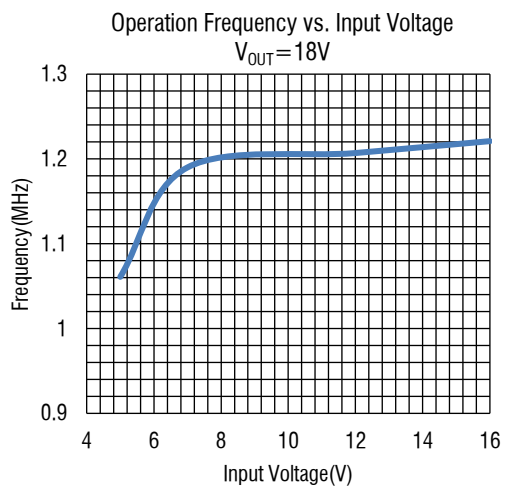
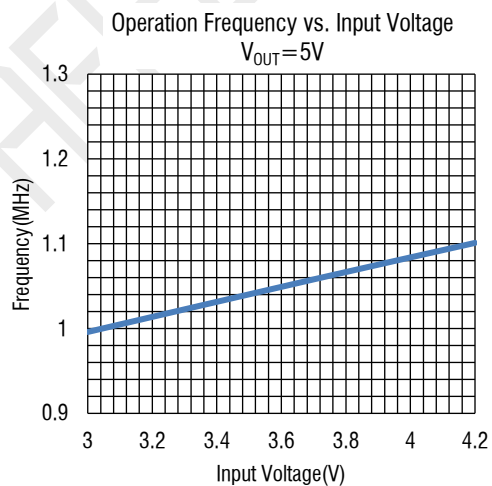
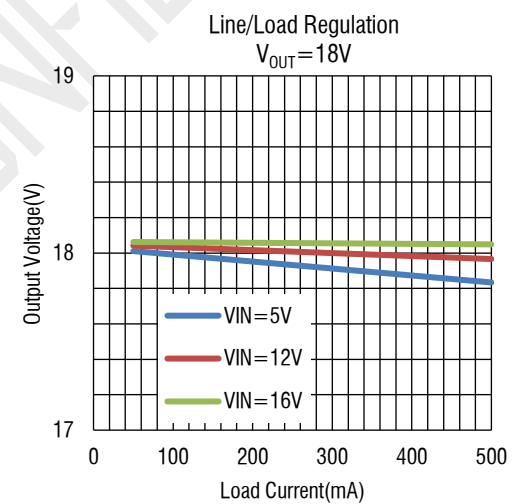
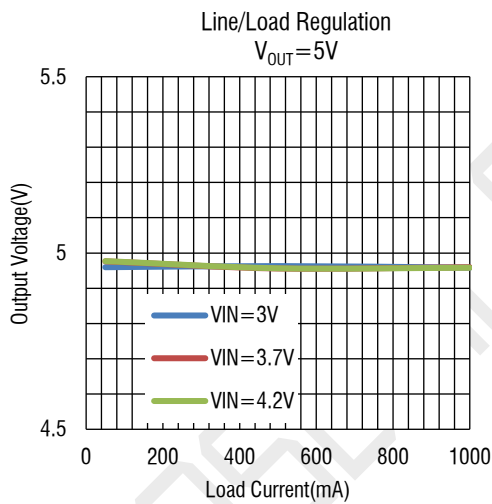
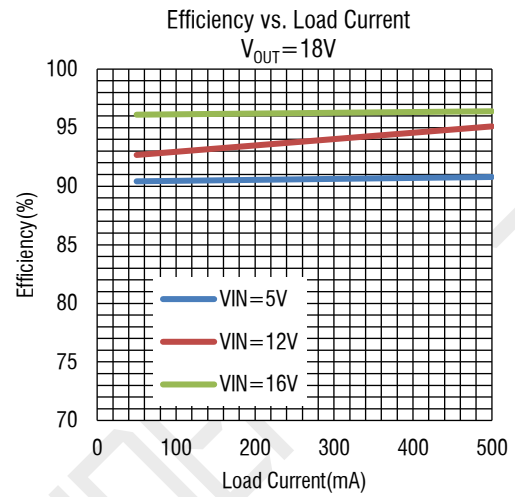
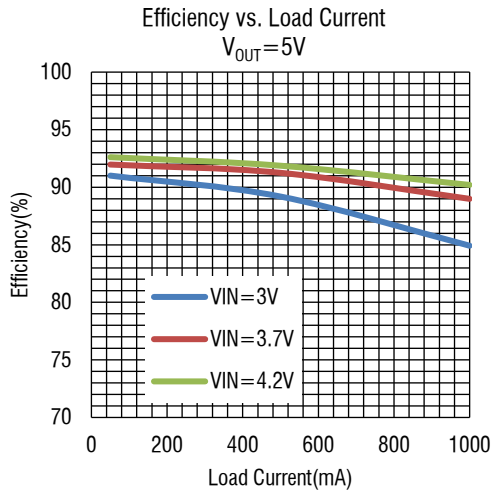

FUNCTIONAL BLOCK DIAGRAM

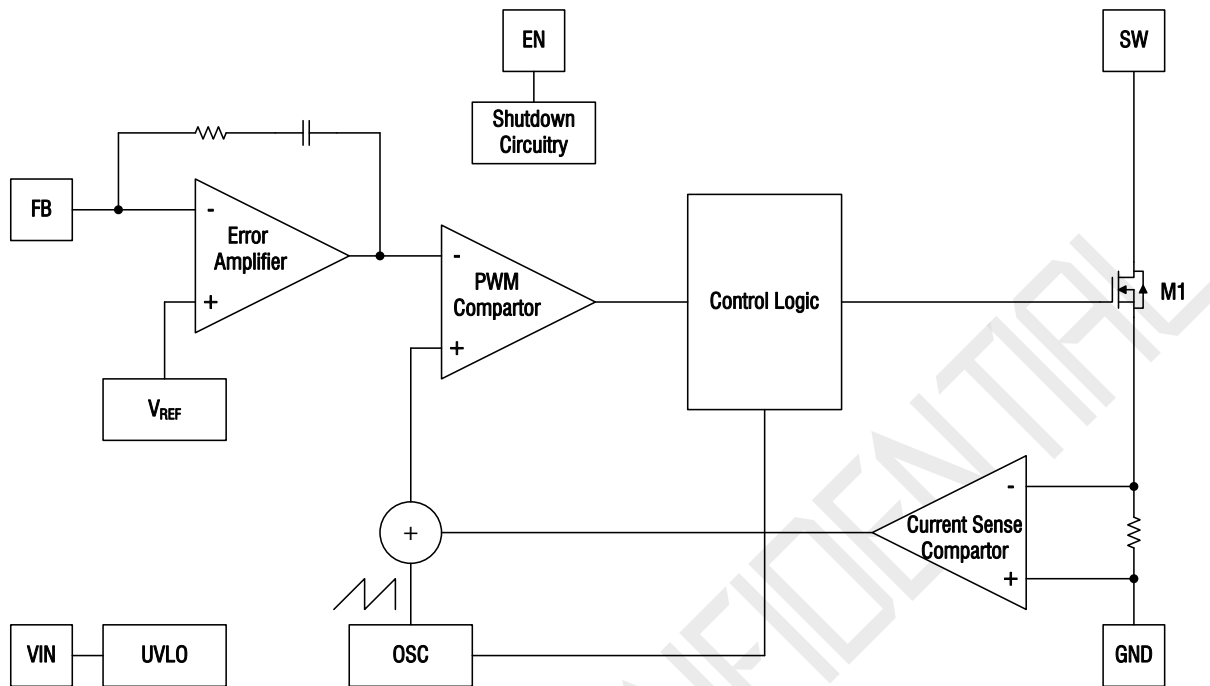

Figure 2. MT3608B Block Diagram

FUNCTIONAL DESCRIPTION

The MT3608B uses a fixed frequency, peak current mode boost regulator architecture to regulate voltage at the feedback pin. The operation of the MT3608B can be understood by referring to the block diagram of Figure 2. At the start of each oscillator cycle the MOSFET is turned on through the control circuitry. To prevent sub-harmonic oscillations at duty cycles greater than 50 percent, a stabilizing ramp is added to the output of the current sense amplifier and the result is fed into the negative input of the PWM comparator. When this voltage equals the output voltage of the error amplifier the power MOSFET is turned off. The

voltage at the output of the error amplifier is an amplified version of the difference between the 0.6V bandgap reference voltage and the feedback voltage. In this way the peak current level keeps the output in regulation. If the feedback voltage starts to drop, the output of the error amplifier increases. These results in more current to flow through the power MOSFET, thus increasing the power delivered to the output. The MT3608B has internal soft start to limit the amount of input current at startup and to also limit the amount of overshoot on the output.

APPLICATIONS INFORMATION

Setting the Output Voltage

The internal reference V_{REF} is 0.6V (Typical).The output voltage is divided by a resistor divider,R1 and R2 to the FB pin. The output voltage is given by

$$V_{OUT} = V_{REF} \times \left(1 + \frac{R_1}{R_2}\right)$$

Inductor Selection

The recommended values of inductor are 4.7 to 22 μ H. Small size and better efficiency are the major concerns for portable device, such as MT3608B used for mobile phone. The inductor should have low core loss at 1.2MHz and low DCR for better efficiency. To avoid inductor saturation current rating should be considered.

Capacitor Selection

Input and output ceramic capacitors of 22 μ F are recommended for MT3608B applications. For better voltage filtering, ceramic capacitors with low ESR are recommended. X5R and X7R types are suitable because of their wider voltage and temperature ranges.

Diode Selection

Schottky diode is a good choice for MT3608B because of its low forward voltage drop and fast reverses recovery. Using Schottky diode can get better efficiency. The high speed rectification is also a good characteristic of Schottky diode for high switching frequency. Current rating of the diode must meet the root mean square of the peak current and output average current multiplication as following

$$I_D (RMS) \approx \sqrt{I_{OUT} \times I_{PEAK}}$$

The diode' s reverse breakdown voltage should be larger than the output voltage.

Layout Consideration

For best performance of the MT3608B, the following guidelines must be strictly followed.

- Input and Output capacitors should be placed close to the IC and connected to ground plane to reduce noise coupling.
- The GND should be connected to a strong ground plane for heat sinking and noise protection.
- Keep the main current traces as possible as short and wide.
- SW node of DC-DC converter is with high frequency voltage swing. It should be kept at a small area.
- Place the feedback components as close as possible to the IC and keep away from the noisy devices.

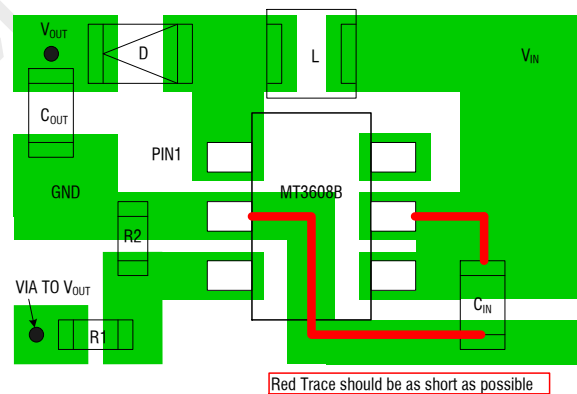
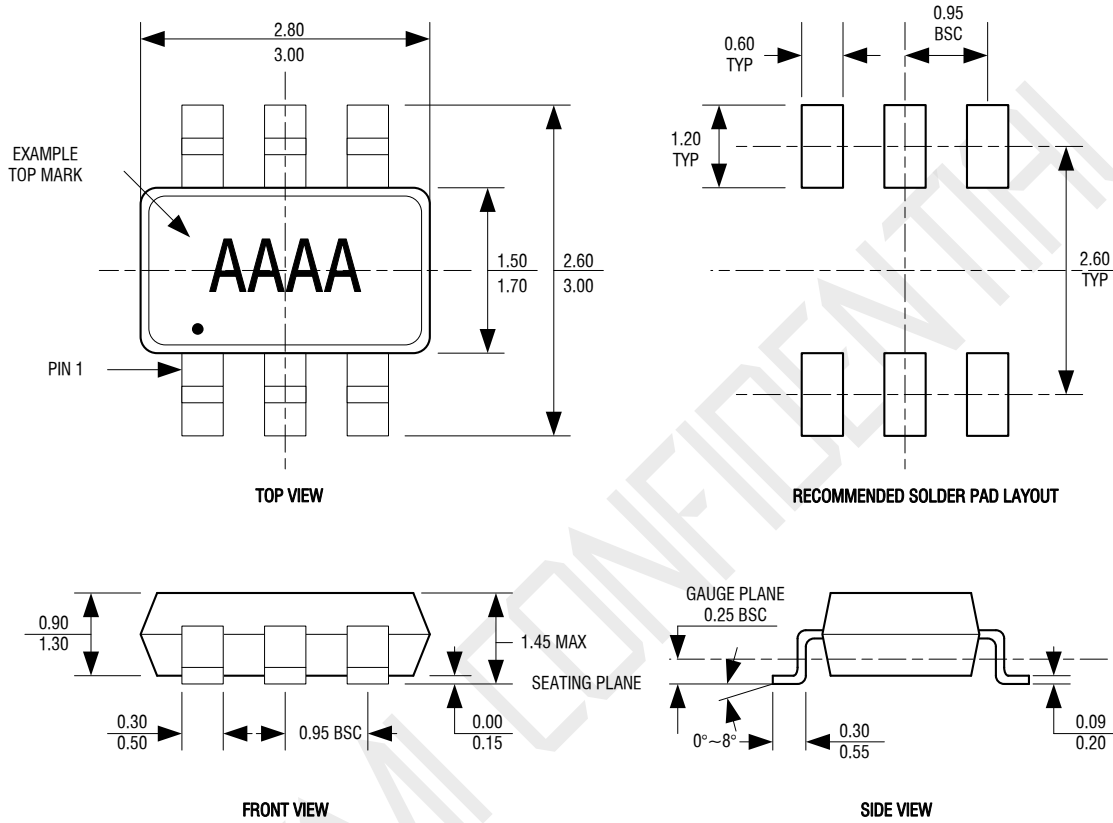

Figure 3. MT3608B Suggested Layout

PACKAGE DESCRIPTION

SOT23-6



- NOTE:**
- 1.DIMENSIONS ARE IN MILLIMETERS.
 - 2.DRAWING NOT TO SCALE.
 - 3.DIMENSIONS ARE INCLUSIVE OF PLATING.
 - 4.DIMENSIONS ARE EXCLUSIVE OF MOLD FLASH AND METAL BURR.

IMPORTANT NOTICE

Xi'an Arosemi Technology Co.,Ltd reserve the right to make corrections, enhancements, improvements and other changes to its semiconductor products and services.

Xi'an Arosemi Technology Co.,Ltd is not responsible or liable for such altered documentation. Information of third parties may be subject to additional restrictions.

Xi'an Arosemi Technology Co.,Ltd does not assume any responsibility for use of any its products for any particular purpose, nor does Xi'an Arosemi Technology Co.,Ltd assume any liability arising out of the application or use of any its products or circuits.

Copyright © 2011, Xi'an Arosemi Technology Co.,Ltd

Tel: 0755-82879616 029-88868021

Http://www.arosemi.com