

SMD CRYSTAL UNIT SPECIFICATIONS

Customer	
Customer P/N	
Product	2016 Seam Sealing Crystal
Nominal Frequency	20.000000MHz
HOSONIC P/N	E1SB20E000007E
Version	10C0
Issue Date	2017/11/27

HOSONIC		
Drawn	Checked	Approved
LUCY	ZOE	JOHN

Approved By Customer : _____



HOSONIC ELECTRONIC CO., LTD.



Revised Record

Rev.	Rev. Date	Item	Content	Remark
1.0	2017-11-27		Initial released	

I ELECTRICAL PARAMETERS

Electrical characteristics measured by S&A250B or equivalent.

No.	Item	Symb.	Electrical Specification				Remark
			Min.	Typ.	Max.	Units	
1	Nominal Frequency	F0	20.000000			MHz	
2	Mode of Vibration		Fundamental				
3	Frequency Tolerance	$\Delta F/F0$	-15	-	15	ppm	At 25°C±3°C
4	Operating Temperature Range	T _{OPR}	-40	-	105	°C	
5	Frequency Stability (over operating temperature)	TC	-30	-	30	ppm	Ref. to 25°C
6	Storage Temperature	T _{STG}	-55	-	125	°C	
7	Load capacitance	CL	-	12	-	pF	
8	Equivalent Series Resistance	ESR	-	-	100	Ω	
9	Drive Level	DL	-	50	100	μW	
10	Insulation Resistance	IR	500	-	-	MΩ	At 100V _{DC}
11	Shunt Capacitance	C0	-	-	3	pF	
12	Aging Per Year	Fa	-2	-	2	ppm	First Year
13	Package type	E1SB					

NOTE: Storage Temperature is only for the product itself, the temperature for the packing material is -4~40°C.

I OUTLINE DIMENSIONS (UNIT: mm)

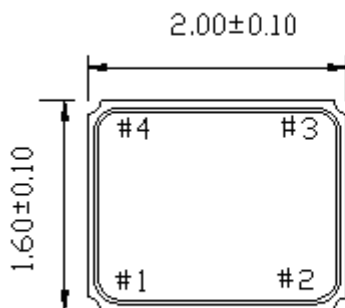

Top View

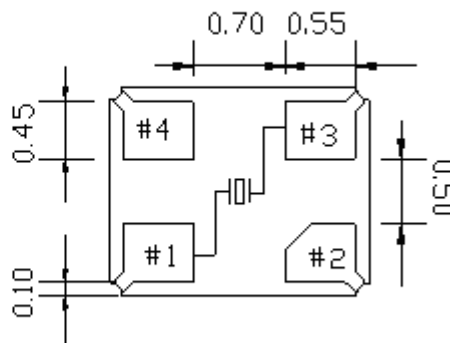

Recommended Solder Pattern

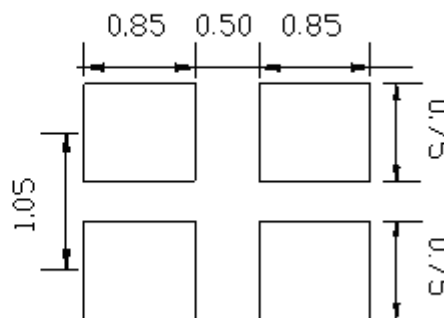
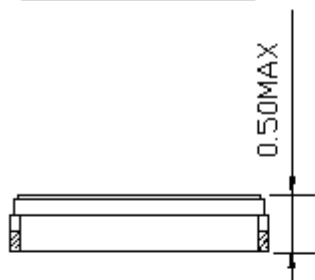

Pin	Connection
#1,#3	X'tal
#2,#4	GND

I MARKING

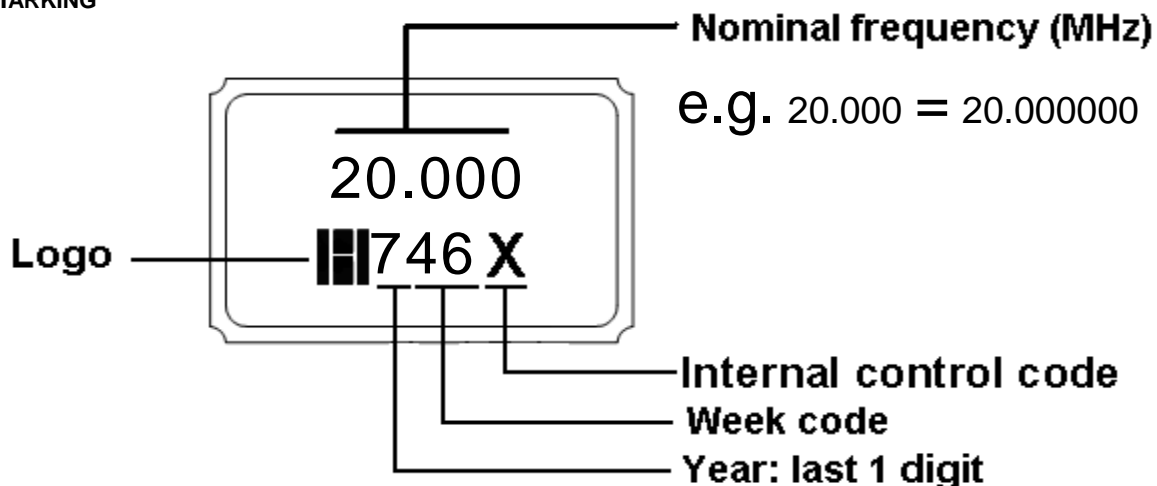

NOTE: The internal control code maybe blank.

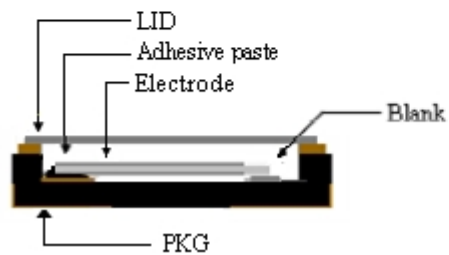
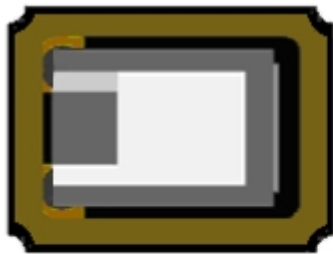
I PRODUCT LAYOUT

NO.	PART	MATERIAL	REMARK
1	LID	KOVAR(Fe+Co+Ni alloy)	
2	PKG	Al ₂ O ₃	Base
3	Blank	SiO ₂	Quartz
4	Adhesive paste	Ag/Silicon	Support
5	Electrode	Noble metal	

I REFLOW PROFILES

Profiles Feature	Pb-Free Assembly
Average Ramp-up Rate (Ts max to Tp)	3°C/second max.
Preheat	
■ Temperature Min (Ts min)	125°C
■ Temperature Max (Ts max)	200°C
■ Time (ts min to ts max)	60~180 seconds
Time maintained above	
■ Temperature (TL)	217°C
■ Time (tL)	60~150 seconds
Peak/Classification Temperature (Tp)	260°C
Time within 5°C of actual Peak Temperature (tp)	20~40 seconds
Ramp-down rate	6°C/second max.
Time 25°C to Peak Temperature	8 minutes max.
Suggest reflow times	3 Times max

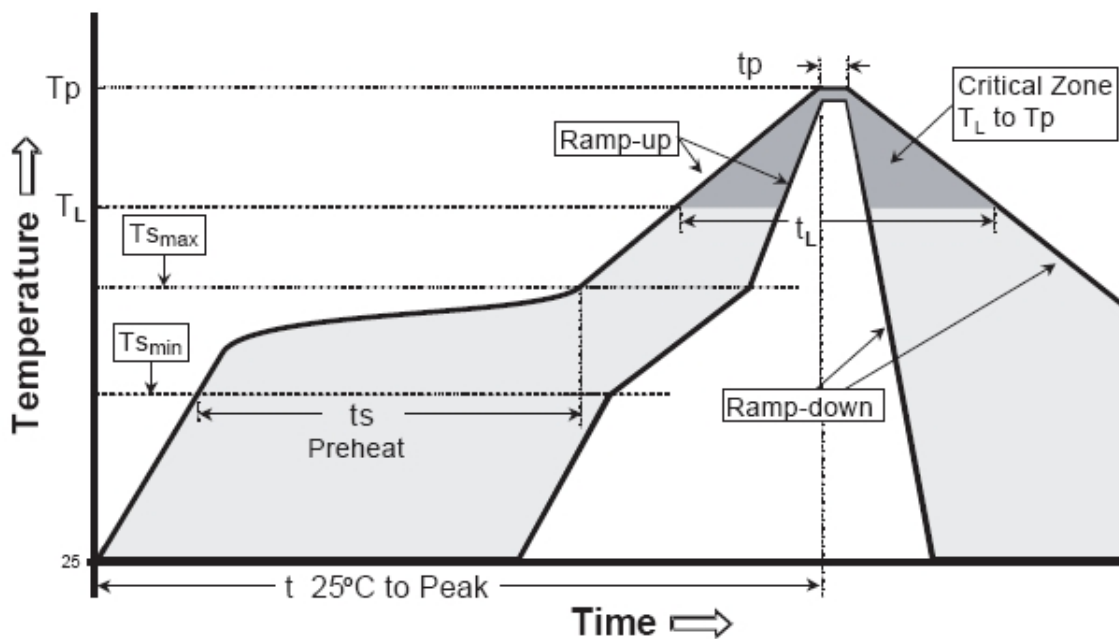

Remark: To reference JEDEC J-STD-020C

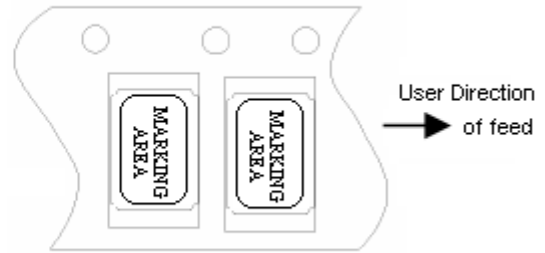
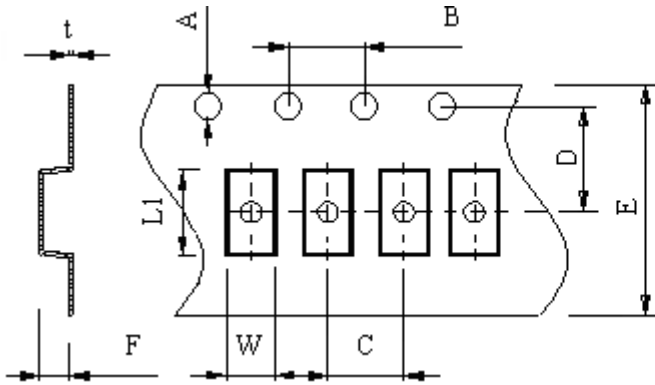
I PACKAGE(reference to EIA-481)
Tape Dimensions(unit : mm)

Start & End Point

A	B	C	D	E	F	L1	W	t
1.50	4.0	4.0	3.5	8.0	0.65	2.25	1.85	0.2

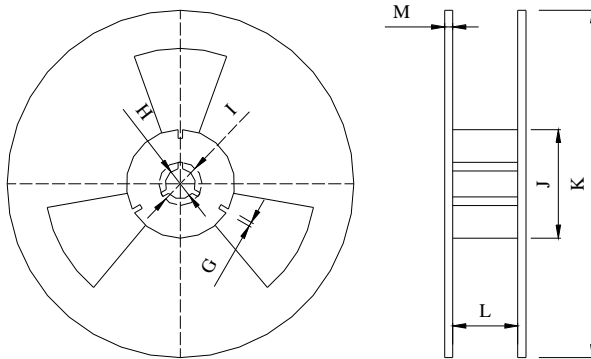
Reel Dimensions(unit: mm)

G	H	I	J	K	L	M
2.5	13.5	21.6	60.0	178	9.5	1.6

*3000pcs/Reel

Carton Dimension (unit : mm)



1 reel = 1 Inner box

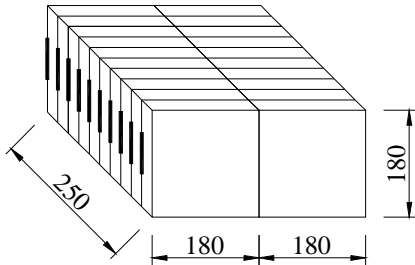

20 Inner boxes = 1 Carton

60kpcs = 1 Carton

I RELIABILITY SPECIFICATIONS

No.	Test Item	Test Conditions	Reference
1	High Temperature Storage	Temperature: 125°C ± 5°C Time: 1000 ± 12 Hours	MIL-STD-883E-1016
2	Temperature Cycle	Temperature 1: -55°C ± 5°C Temperature 2: 125°C ± 5°C Temperature change between T1 and T2 at soonest Run 1000 cycles, maintain T1 and T2 5minutes each in one cycle	JESD22 Method JA-104
3	Solder Heat Resistance	Pre-heat: 125°C 60~120 Seconds Solder Temperature: 260°C ± 5°C Time: 30 Seconds	MIL-STD-202F 210 E
4	Drop Test	3 Times Free Fall from 75cm height table to 3cm thickness hard wood board	MIL-STD-202F-203B
5	High Temperature, High Humidity Storage	Temperature: 85°C ± 5°C Relative Humidity: 80%~85% Time: 250Hours ± 24 Hours	MIL-STD-202F-103B
6	Steam Aging	Temperature: 97°C ± 5°C Time: 24 Hours 260°C solder pot to check solderability	MIL-STD-883 C-1008.2B
7	Solderability	Dip in flux 5~10 seconds Temperature: 245°C ± 5°C Time: 10 Seconds	MIL-STD-202F-208H
8	Aging	Temperature: 85°C ± 5°C Time: 250 ± 12Hours	MIL-STD-202 F-108A
9	Thermal Shock	Temperature 1: -55°C ± 5°C Temperature 2: 125°C ± 5°C Temperature change between T1 and T2: 5 seconds 100 cycles, maintain T1 and T2 for 30 minutes each in one cycle	MIL-STD-883E-1011.9B
10	Vibration	Frequency Range: 10Hz~2000Hz Amplitude: 1.5mm or 20G 4Hours in each direction, total 12Hours	MIL-STD-202F-204D