

雅晶鑫電子

Shenzhen Yajingxin Electron Co.,Ltd

Customer	
Production Name	SMD CRYSTAL SEAM 3.2*2.5
Customer P/N	N/A
P/N	TX322526M4DBDD2T
Revision	A
Print Date	2022-12-05

Drawn	Checked	Approved
		



RoHS Compliant

● ELECTRICAL PARAMETERS

谐振器产品技术指标		Min	Max	Units
1.Holder Type(型号规格)		SEAM 3.2*2.5		
2.Mode of Oscillation (振动模式)		Fundamental		
3. Frequency (标称频率)		26.000000		MHz
4.Load Capacitance (CL) (负载电容)		10		pF
5.Drive Level (激励功率)		100		uw
6.Equivalent Resistance (谐振电阻)			30	Ω
7.Shunt Capacitance (Co) (静态电容)		0	5	pF
8.Motional Capacitance (C1) (动态电容)		N/A		fF
9.Frequency Tolerance at 25℃ (调整频差)		-10	10	ppm
10.Stability over operation temperance (温度频差)		± 20		ppm
11.Insulation Resistance (at DC 100V) (绝缘电阻)		500MΩ Min @100V		MΩ
12.Operating Temperature Range (工作温度范围)		-30	85	℃
13. Storage Temperature Range (储存温度范围)		-45	85	℃
14. Aging (老化率)		± 3		ppm/year
15. DLD2	N/A		N/A	Ω
16. FLD2			N/A	ppm
17. RLD2			N/A	Ω
18. SPDB	N/A		N/A	db
19. Other(其它)		N/A		

OUTLINE DIMENSIONS(UNIT:mm) 外形尺寸 (单位: mm)

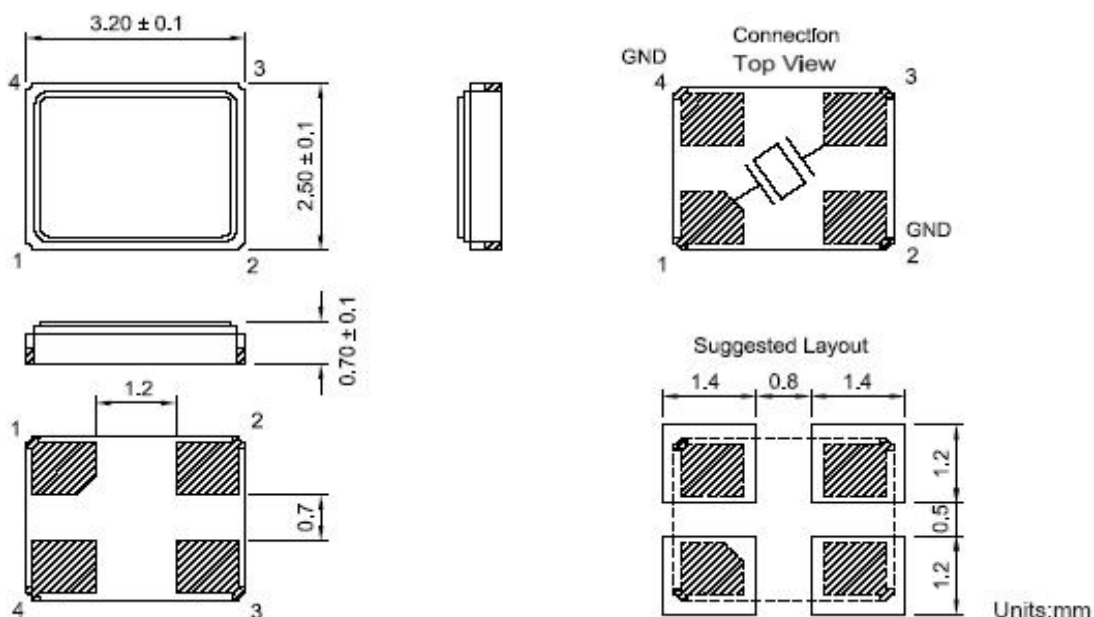

● **SUGGESTED REFLOW PROFILE** (回流焊曲线图)

Total time:200sec.Max. (总时间: 200秒 最大)

Solder melting point:220℃ (熔点220℃)

Profiles Feature (特性)		Pb-Free Assembly
Average Ramp-up Rate(Ts max to Tp) 平均升温速度		3℃/second Max
Preheat	预热	
■ Temperature Min (Ts min)	最低温度	125℃
■ Temperature Max (Ts max)	最高温度	200℃
■ Time (ts min to ts max)	从最低到最高时间	(60~180) seconds
Time maintained above		
■ Temperature(T1)	温度	217℃
■ Time(tp)	时间	(60~150) seconds
Peak/Classification Temperature(Tp) 最高点温度		260℃
Time within 5℃ of actual Peak Temperature(tp)		
	高温维持时间	(20~40) seconds
Ramp-down rate		
	降温速度	6℃/second max
Time 25℃ to Peak Temperature		
	从25℃到最高温度的时间	8 minutes max
Suggest reflow times		
	建议 reflow次数	3 Times max

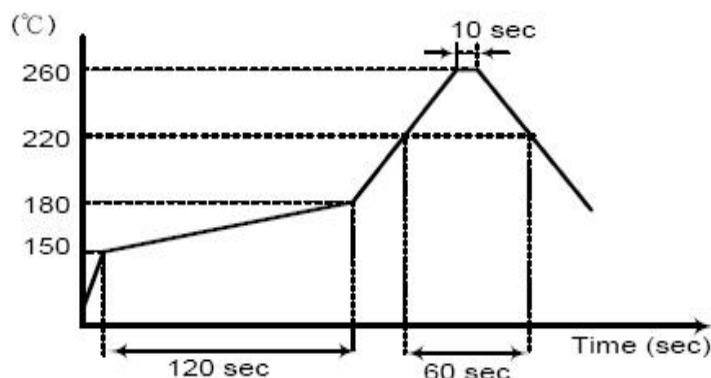

●● PACKING (包裝) 3Kpcs/REEL

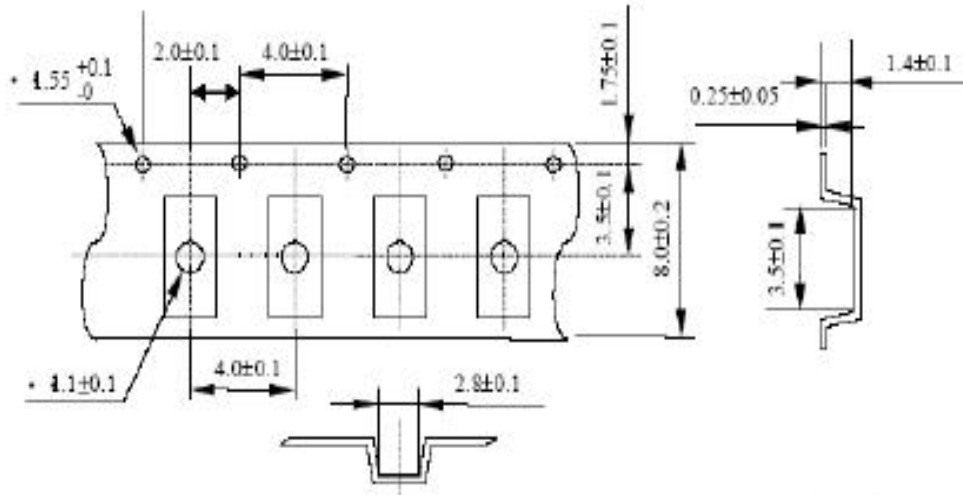

[Size in mm]

8.3. Reel dimension & Outline drawing

Material of the Reel : PS

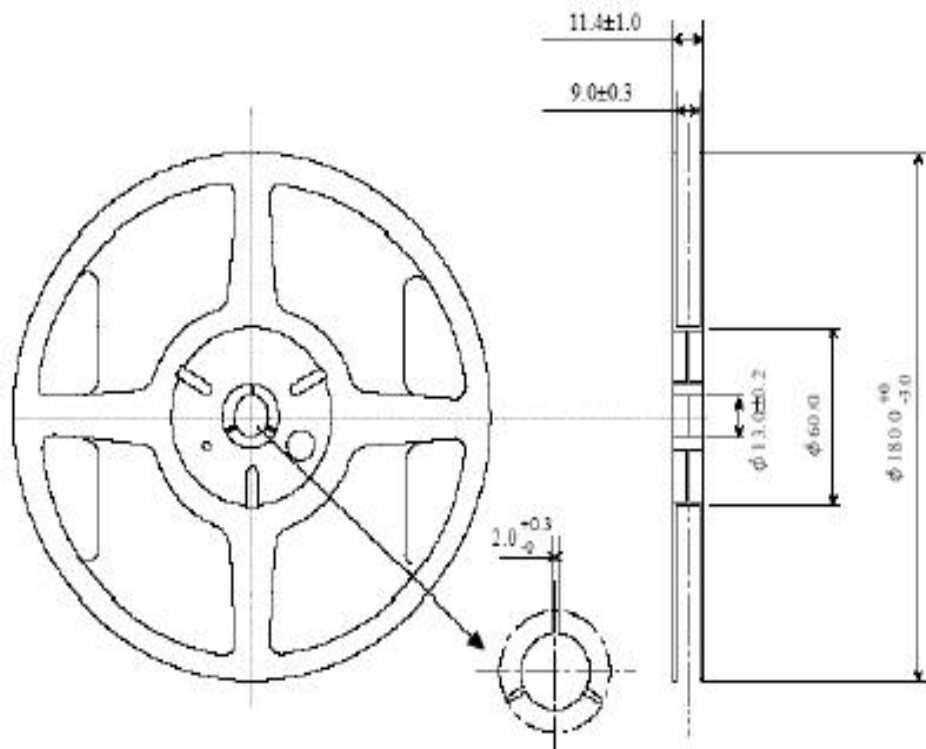

雅晶鑫電子

Shenzhen Yajingxin Electron Co.,Ltd

● RELIABILITY SPECIFICATIONS (信赖度试验)

No	Test Item (测试项目)	Test Conditions (测试条件)	Reference (参考)
1	High Temperature High Humidity Storage (高温、高湿、储存)	Temperature: 85°C±3°C 温度: 85°C±3°C Relative Humidity:85%RH 相对湿度: 85%RH Time: 96 Hours 时间: 96小时	JIS C5023
2	High Temperature Storage (高温储存)	Temperature: 125°C±3°C 温度:125°C±3°C Time: 96 Hours 时间:96 小时	MIL-STD-883E Method 1005.8
3	Low Temperature Storage (低温储存)	Temperature: -40°C±3°C 温度: -40°C±3°C Time: 96Hours 时间: 96小时	MIL-STD-883E Method 1013
4	Thermal Shock (温度冲击)	Temperature1:-55°C±5°C 温度1:-55°C±5°C Temperature2:85°C±5 °C 温度2: 85°C±5 °C Temperature change between T1 and T2 5 min T1和T2温度在5分钟内改变 10cycles maintain T1 and T2 for 30 minutes each mone 每次循环30分钟共10次	MIL-STD-202F Method 107 Condition A
5	RESISTANCE TO SOLDER HEAT (耐焊接热)	Solder Temperature: 260°C±5°C 焊槽温度:260°C±5°C Time: 10±1 Seconds 时间: 10±1秒	MIL-STD-202F Method 210E
6	Solderability(可焊性)	The solder pot temperature is 245±5°C , dwell tim 245±5°C焊锡槽浸润5±0.5秒	J-STD-002B
7	Drop Test (落下试验)	3 Times Free Fall from 75cm height table to 3cm thickness hard wood board 从75cm高度3次跌落到3cm厚硬质木板上	JIS C6701
8	MECHANICAL SHOCK (机械冲击)	Half sine wave,1000 G 半正弦波,加速度1000G 3 Times for all 3 directions X、Y、Z 三个相互垂直方向各三次	MIL-STD-202F Method 213B
9	Vibration (机械振动)	Frequency Range: 10Hz~55Hz 频率范围: 10Hz~55Hz Amplitude: 0.75mm 振幅: 0.75mm 2 Hours in each direction, total 6 Hours X、Y、Z 三个相互垂直方向各振动2小时	MIL-STD-883E Method 2007.3
10	Leakage Test (气密性)	Take measurements with a helium Leakage detector 氦质检漏 Leakage Rate≤1×10 ⁻³ Pa cm ³ /s 漏率≤1×10 ⁻³ Pa cm ³ /s	MIL-STD-883E