

ROHS

多种规格，可参考选型表

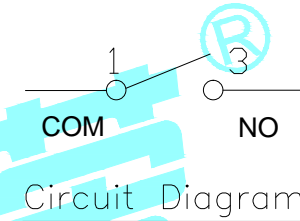
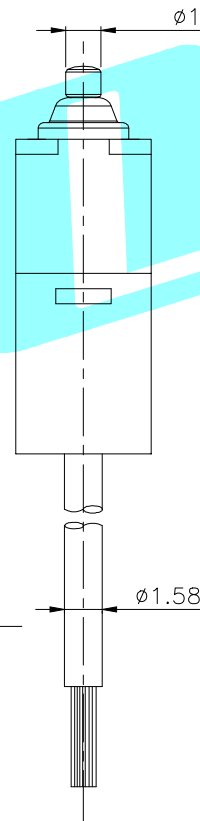
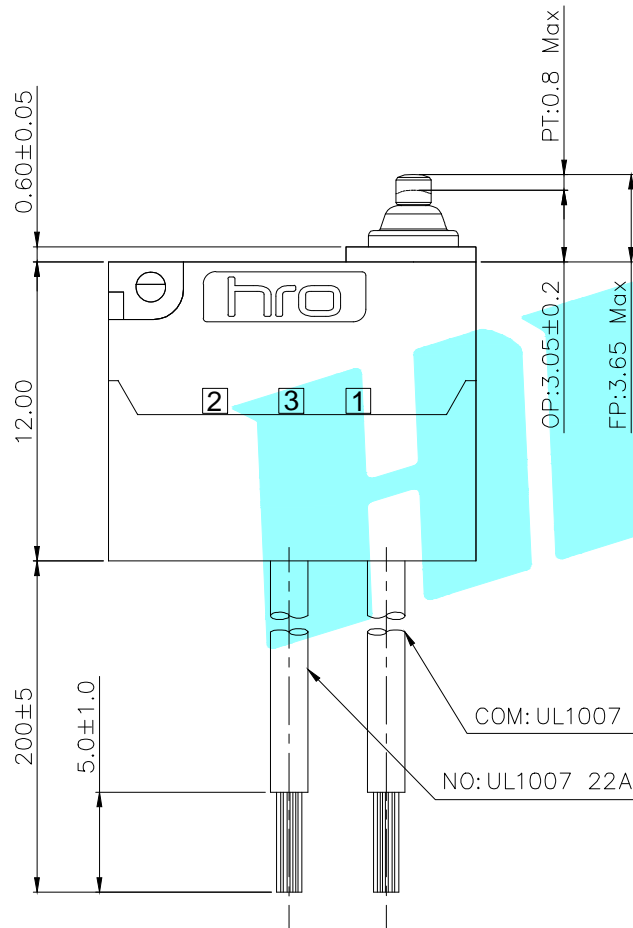
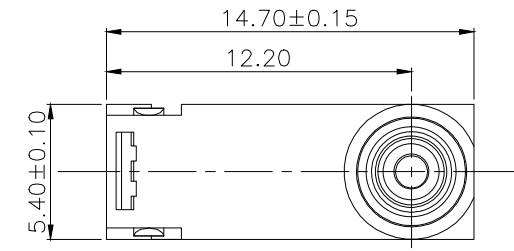

NOTE:

- 1.Rating1:DC12V 3A
Rating2:48V DC/125V AC/250V AC 0.1A
- 2.Operating froce:130gf MAX
- 3.Electric Life:100,000
- 4.Mechanical Life:500,000
- 5.Ingress protection:IP67

ITEM	PART NAME	TER'NO.	QTY.	MATERIAL	FINISHING	REMARK
⑦	Shrapnel	—	1	Brass	Plating silver	—
⑥	Contact	—	1	Ag	—	—
⑤	Sealed Circle	—	1	Silicone Rubber	—	—
④	Terminal	—	2	Brass(0.50t)	Plating silver	—
③	Plunger	—	1	POM	Black	—
②	Case	—	1	PA	Black	—
①	Cover	—	1	PA	Black	—

APPROVALS		DATE		 ELECTRONICS CO.,LTD		
DRAWN	LIUCAN	2021.3.31				
CHECKED				TITLE: MICRO SWITCHS		
APPROVALS				PART NO. K9-2811N-OWBN-1B		
TOLERANCES ARE		30~以上 ±0.30	±0.20	ANGLE	UNIT: mm	SCALE: 1:1
		10~30 ±0.20	±0.15			
		5~10 ±0.15	±0.10			
		~ 5 ±0.10				

ECN NO.	REV.	DATE.	DESCRIPTION.	CHANGE.	CHECK.	APPRO.
	A		NEW			



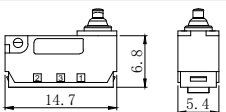

K9-281□选型表

K9-2811N-1SDA-1A











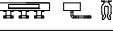

开关系列	名称
K9	防水微动开关

编码	图示	产品规格
1		A型 14.7*5.4*6.8(柱型导芯)

编码	额定负载
1	3A 12V DC
	0.1A 125/250V AC
	0.1A 48V DC
2	10(1.5)A 250V AC









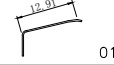
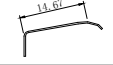

编码	图示	定位类型
N		无定位柱
R		右侧双定位柱
L		左侧双定位柱
D		两侧双定位柱
Q		其它

编码	定位柱长度L
0	无定位柱
1	1.5MM
2	2.0MM
3	2.5MM
4	3.0MM
5	3.5MM
6	5.0MM
7	1.3MM

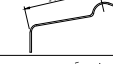
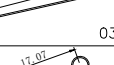
编码	端子类型	编码	端子类型
S		T	
H		E	
B		W	
P		X	
K		Y	
M			
L			
R			





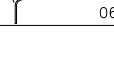
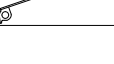







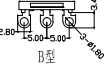

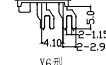

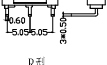
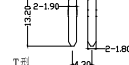











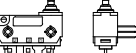





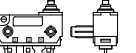
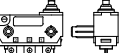
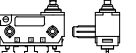
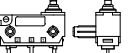
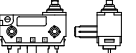

编码	线材长度L	编码	线材长度L
0	无线材省略	C	250mm
A	150mm	D	300mm
B	200mm	其它	...

流水号	电线规格	流水号	电线规格
0	无线材省略	5	0.14mm ² *6C
1	UL1007 22AWG美标	6	UL1007 24AWG美标
2	AVSS0.3日标	7	特氟龙24AWG
3	AVSS0.5日标	8	VW-1 1015 20AWG
4	UL1007 20AWG美标	9	UL2468 24AWG VW-1 80℃

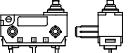
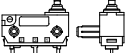
编码	手柄类型	编码	手柄类型	编码	手柄类型
A		F		J	
B		G		K	
C		H		L	
D		Q		M	
E		P		N	无手柄

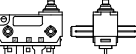
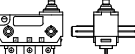
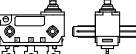
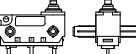
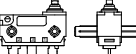

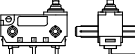



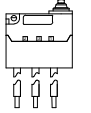
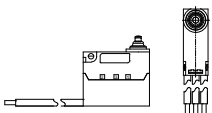
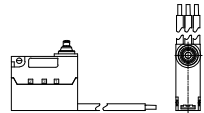
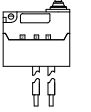
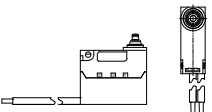
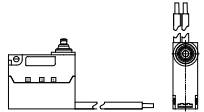
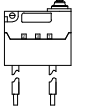
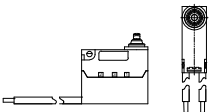
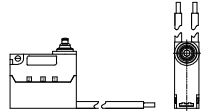

编码	触点类型
D	常开/常闭 SPDT
B	常开 SPST-NO
C	常闭 SPST-NC

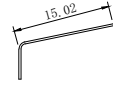
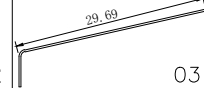
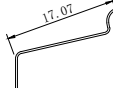
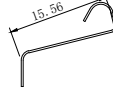
A型 选型表

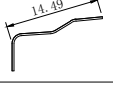
端子类型 定位柱类型		S型	H型	B型	P型	K型	M型	L型	R型	T型	其他/Other
											其他/Other
N											
R											
L											
D											
备注：定位柱长度"L"通常为1.5MM、2.0MM、2.5MM、3.0MM、3.5MM、5.0MM,也可根据客户需求定制长度											

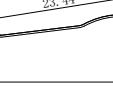
端子类型 触点类型		W	X	Y
D 常开/常闭				
B 常开				
C 常闭				

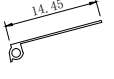
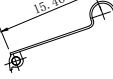
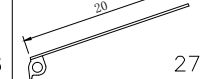
手柄类型

手柄	插入式	 12.91 01	 15.02 02	 29.69 03	 17.07 05	 15.56 06
	外扣式	 14.67 07	 14.49 08	 12.87 09	 23.44 22	 17.16 23
		 14.45 26	 15.46 28	 20 27	 13.9 19	