

18V Vin, 6A, High Efficiency Synchronous Step-down DCDC Converter

FEATURES

- Wide 4.5V -18V Input Voltage Range
- 0.6V-7V Output Voltage Range
- 6A Continuous Output Current
- Integrated 42mΩ/17mΩ HS/LS Power MOSFETs
- Fixed 1ms Soft-start Time
- Selectable 400KHz, 800KHz and 1.2MHz Switching Frequencies
- Selectable PFM and USM Operation Modes
- Cycle-by-Cycle Current Limiting
- Output Over-Voltage Protection
- Over-Temperature Protection
- 12-pin 2mmx3mm QFN Package

APPLICATIONS

- High End DTV
- Set-top Box, XDSL Modem, Personal Video Recorders
- Server, Cloud-Computing, Storage
- Telecom & Networking, Small-cell Base Stations, Point-of-Load (POL)
- IPCs, Factory Automation

DESCRIPTION

The SCT2260C is a high efficiency synchronous step-down DC-DC converter with 4.5V-18V input voltage range and adjustable output voltage down to 0.6V. It offers a small space-saving 2mmx3mm QFN package that supplies continuous 6A output current. The device fully integrates high-side and low-side power MOSFETs with 42mΩ/17mΩ on-resistance to minimize the conduction loss.

The SCT2260C adopts a Constant On-Time (COT) control to provide fast transient response and easy loop stabilization. The switching clock frequency can be selected from 400KHz, 800KHz and 1.2MHz for optimization of the filter size and output voltage ripple. The device offers soft start to prevent inrush current during the startup of output voltage ramping. Power Good with open drain output signals that the output voltage is within regulation.

The SCT2260C has the MODE pin to select Pulse Frequency Modulation (PFM) operation mode to achieve the light load power save, or Ultrasonic Mode (USM) to keep the switching frequency above audible frequency areas during light-load or no-load conditions, or forced Pulse Width Modulation (PWM) to achieve smaller output ripple.

Full protection includes over current protection, under-voltage protection, and thermal shutdown.

The converter requires a minimum number of external components and is available in a 12 pin (2mmx3mm) QFN package.

TYPICAL APPLICATION

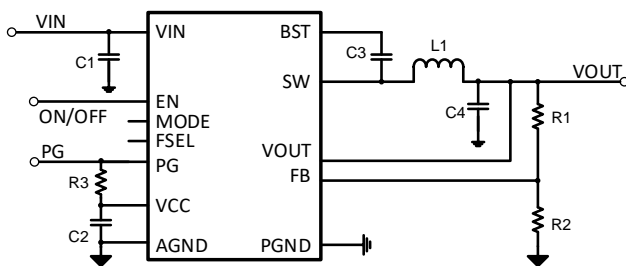

4.5V-18V, Synchronous Buck Converter

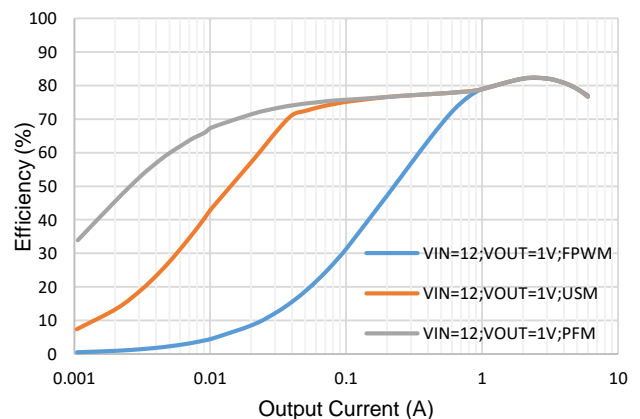

Vin=12V, Vout=1.0V, fsw=800kHz

SCT2260C

REVISION HISTORY

NOTE: Page numbers for previous revisions may differ from page numbers in the current version.

Revision 1.0: Production

Revision 1.1: Update char and typical application waveforms

Revision 1.2: Update AGND connection of application in page1 and page 12

DEVICE ORDER INFORMATION

PART NUMBER	PACKAGE MARKING	PACKAGE DISCIPTION
SCT2260CFPA	260C	12-Lead 2mm×3mm Plastic QFN
1) For Tape & Reel, Add Suffix R (e.g. SCT2260CFPAR).		

ABSOLUTE MAXIMUM RATINGS

Over operating free-air temperature unless otherwise noted⁽¹⁾

DESCRIPTION	MIN	MAX	UNIT
VIN, EN	-0.3	19	V
BST	SW-0.3	SW+6	V
SW	-1	VIN+0.3	V
MODE	-0.3	6	V
FB	-0.3	6	V
FSEL	-0.3	6	V
VOUT	-0.3	6	V
PG	-0.3	6	V
Operating junction temperature T _J ⁽²⁾	-40	125	°C
Storage temperature T _{STG}	-65	150	°C

- (1) Stresses beyond those listed under Absolute Maximum Rating may cause device permanent damage. The device is not guaranteed to function outside of its Recommended Operation Conditions.
- (2) The IC includes over temperature protection to protect the device during overload conditions. Junction temperature will exceed 150°C when over temperature protection is active. Continuous operation above the specified maximum operating junction temperature will reduce lifetime.

PIN FUNCTIONS

NAME	NO.	PIN FUNCTION
VIN	1	Input voltage. Decouple the input rail with at least 0.1uF input ceramic capacitor. Place the capacitor as close to VIN and PGND pins as possible. Use wide PCB traces and multiple VIAs to make the connection. SCT2260C is a high efficiency power converter with 2-3ns fast turning on and turning off power MOSFETs for the best efficiency. If not placing the input capacitor close to VIN and GND pin, the voltage spike caused by trace parasitic inductance might EOS damage the device.
PGND	2	Power ground. Use wide PCB traces and multiple vias to handle the load current.
PG	3	Power good indicator. Active low open-drain output. Connect to a source voltage through an external pill resistor between 10k to 100k. PG is high if the output voltage is higher than 95% or lower than 105% of the nominal voltage.

PIN CONFIGURATION

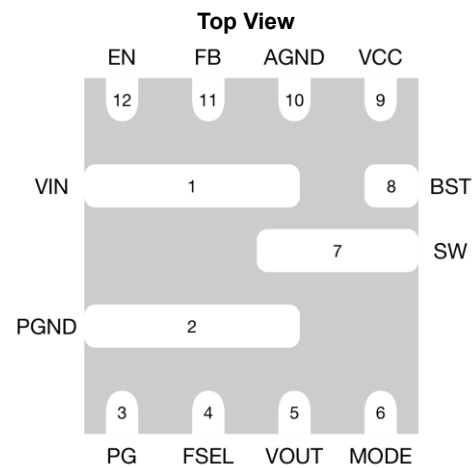

Figure 1. 12-Lead Plastic QFN (2mm×3mm)

FSEL	4	Switching frequency selection. Connecting to ground sets clock frequency to 400KHz. Floating sets clock frequency to 800KHz. Connecting to VCC sets clock frequency to 1.2MHz.
VOUT	5	VOUT is used to sense the output voltage of the buck regulator. Connect VOUT to the output capacitor of the regulator directly. Keep the VOUT sensing trace far away from the SW node. VIAs should also be avoided on the VOUT sensing trace. A trace larger than 25mil is required.
MODE	6	PFM, USM and PWM mode selection. Connect the pin to VCC to force the device in forced Pulse Width Modulation (PWM) operation mode. Ground the pin to operate the device in Pulse Frequency Modulation (PFM) mode without Ultrasonic Mode (USM). Floating the pin to operate the device in PFM with USM.
SW	7	Switch output. Connect SW to the inductor and bootstrap capacitor. SW is driven up to VIN through the high-side power MOSFET during on-time. The inductor current drives SW to negative voltage through low-side power MOSFET during off-time. Use wide and short PCB traces to make the connection. Keep the SW pattern area minimized.
BST	8	Bootstrap. Must connect a 0.1uF capacitor or greater between SW and BST to form a floating supply across the gate driver of high-side power MOSFET.
VCC	9	Internal VCC LDO output. The driver and control circuits are powered by VCC. Decouple with 1uF ceramic capacitor placed as close to VCC as possible.
AGND	10	Signal logic ground. AGND is the Kelvin connection to PGND.
FB	11	Feedback voltage Input. Connect FB to the tap of a resistor divider from output voltage to AGND to set up output voltage. The device regulates FB to the internal reference value of 0.6V typical.
EN	12	Enable logic input. EN is a digital input that controls the converter on or off. EN high turns on the device and EN low turns off the device. Connecting to VIN with a 100kΩ pull-up resistor can enable the device. Floating EN pin automatically starts up the converter.

RECOMMENDED OPERATING CONDITIONS

Over operating free-air temperature range unless otherwise noted

PARAMETER	DEFINITION	MIN	MAX	UNIT
V _{IN}	Input voltage range	4.5	18	V
V _{OUT}	Output voltage range	0.6	7	V
T _J	Operating junction temperature	-40	125	°C

ESD RATINGS

PARAMETER	DEFINITION	MIN	MAX	UNIT
V _{ESD}	Human Body Model (HBM), per ANSI-JEDEC-JS-001-2014 specification, all pins ⁽¹⁾	-2	+2	kV
	Charged Device Model (CDM), per ANSI-JEDEC-JS-002-2014specification, all pins ⁽¹⁾	-0.5	+0.5	kV

(1) JEDEC document JEP155 states that 500V HBM allows safe manufacturing with a standard ESD control process.

(2) JEDEC document JEP157 states that 250V CDM allows safe manufacturing with a standard ESD control process.

THERMAL INFORMATION

PARAMETER	THERMAL METRIC	DFN-20L	UNIT
R _{θJA}	Junction to ambient thermal resistance ⁽¹⁾	70	°C/W
R _{θJC}	Junction to case thermal resistance ⁽¹⁾	15	

(1) SCT provides R_{θJA} and R_{θJC} numbers only as reference to estimate junction temperatures of the devices. R_{θJA} and R_{θJC} are not a characteristic of package itself, but of many other system level characteristics such as the design and layout of the printed circuit

SCT2260C

board (PCB) on which the SCT2260C is mounted, thermal pad size, and external environmental factors. The PCB board is a heat sink that is soldered to the leads and thermal pad of the SCT2260C. Changing the design or configuration of the PCB board changes the efficiency of the heat sink and therefore the actual $R_{\theta JA}$ and $R_{\theta JC}$.

ELECTRICAL CHARACTERISTICS

$V_{IN}=12V$, $T_J=-40^{\circ}C\sim 125^{\circ}C$, typical value is tested under $25^{\circ}C$.

SYMBOL	PARAMETER	TEST CONDITION	MIN	TYP	MAX	UNIT
Power Supply and Output						
V_{IN}	Operating input voltage		4.5		18	V
V_{INUVLO} $V_{INUVLO\ HYS}$	Vin UVLO rising threshold VIN UVLO Hysteresis		4	4.25 270	4.45	V mV
I_{SD}	Shutdown current	EN=0, Measured on VIN pin		1	3	uA
I_Q	Quiescent current from VIN	EN=2V, Vout=5V, No load, No switching. Measured on VIN pin.		140		uA
V_{CC}	V_{CC} internal LDO regulator voltage	$I_{VCC}=0mA$	4.75	5	5.25	V
V_{CC_LR}	V_{CC} internal LDO load regulation	$I_{VCC}=5mA$		0.5		%
I_{VCC_LIM}	V_{CC} internal LDO current limit	VCC short to ground		27		mA
Reference and Control Loop						
V_{REF}	Reference voltage of FB	$4.5V < V_{in} < 18V$ at Temp= $25^{\circ}C$	0.594	0.6	0.606	V
I_{FB}	FB pin leakage current	$V_{FB}=1.2V$		100		nA
Power MOSFETs						
R_{DSON_H}	High side FET on-resistance	$V_{CC}=5V$		42		m Ω
R_{DSON_L}	Low side FET on-resistance	$V_{CC}=5V$		17		m Ω
Enable and Soft-start						
V_{EN_H} V_{EN_L}	Enable high threshold Enable low threshold			1.18 1.03	1.25	V V
I_{EN}	Enable pin input current	EN=1V	1	1.5	2	uA
I_{EN_HYS}	Enable pin hysteresis current			4		uA
T_{SS}	Soft-start time	VOUT 10% to 90%		1		ms
Operation Mode						
V_{MD_PWM}	PWM mode with logic high threshold	$V_{CC}=5V$	4.15			V
V_{MD_USM}	PFM mode with USM logic threshold		1.5		3.5	V
V_{MD_PFM}	PFM mode input logic low threshold				0.9	V
Switching Frequency						
F_{SW}	Switching frequency	FSEL=0V		400		kHz
		FSEL=open		800		kHz
		FSEL=5V		1200		kHz
T_{ON_TIME}	Minimum On-time	Guaranteed by design		70		ns
T_{OFF_TIME}	Minimum Off-time			250		ns
Power Good						
$PG_{Rising(in)}$	V_{FB} rising, percentage of V_{REF} (Good)			95		%
$PG_{Falling(in)}$	V_{FB} falling, percentage of V_{REF}			85		%
$PG_{Rising(out)}$	V_{FB} rising, percentage of V_{REF}			115		%
$PG_{Falling(out)}$	V_{FB} falling, percentage of V_{REF} (Good)			105		%
PG_{TD}	PG low to high delay			0.5		ms

SYMBOL	PARAMETER	TEST CONDITION	MIN	TYP	MAX	UNIT
V _{PG}	Power Good PG pull-down strength	I _{PG} =4mA		0.6		V
I _{PG_LEAK}	Power Good PG leakage current	V _{PG} =5V			5	uA
Protection						
I _{LIM_P}	LS MOSFET positive current limit	From source to drain	7	8	9	A
I _{LIM_N}	LS MOSFET negative current limit	From drain to source, MODE connects to VCC		2		A
T _{HICCUP}	Hiccup waiting time			7		ms
V _{OVP_R}	V _{FB} OVP threshold % of V _{REF}	V _{FB} rising		122		%
V _{OVP_F}	V _{FB} OVP threshold % of V _{REF}	V _{FB} falling		117		%
V _{UVP_F}	V _{FB} UVP threshold % of V _{REF}	V _{FB} falling		75		%
T _{SD}	Thermal shutdown threshold	T _J rising		150		°C
	Hysteresis			20		°C

TYPICAL CHARACTERISTICS

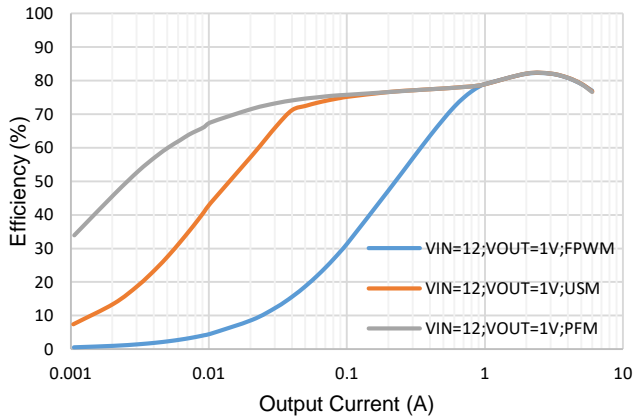

Figure 2. Efficiency vs Iload, Vout=1V, fsw=800kHz

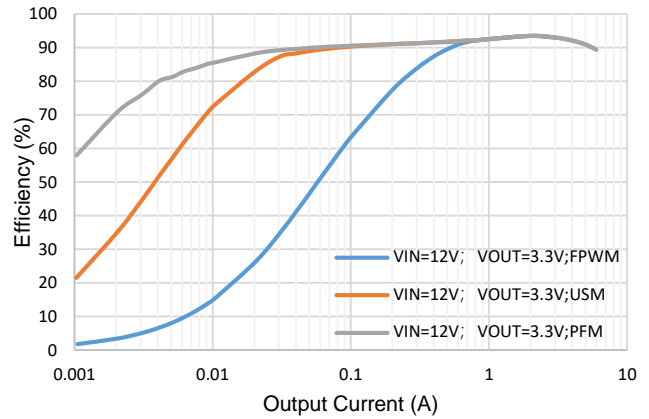

Figure 3. Efficiency vs Iload, Vout=3.3V, fsw=800kHz

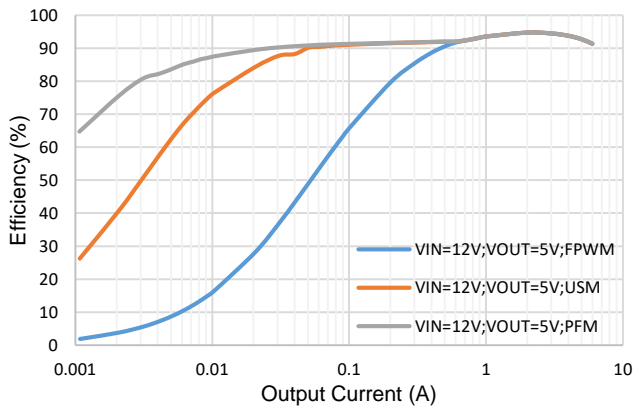

Figure 4. Efficiency vs Iload, Vout=5V, fsw=800kHz

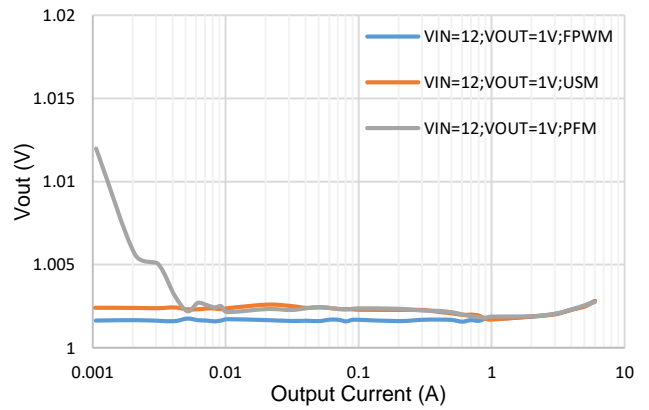

Figure 5. Load Regulation, Vout=1V, fsw=800kHz

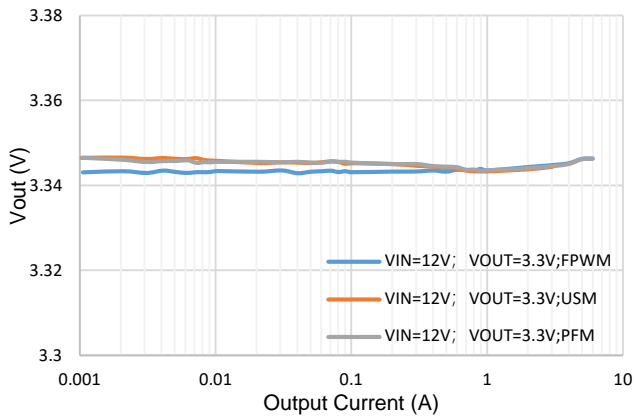

Figure 6. Load Regulation, Vout=3.3V, fsw=800kHz

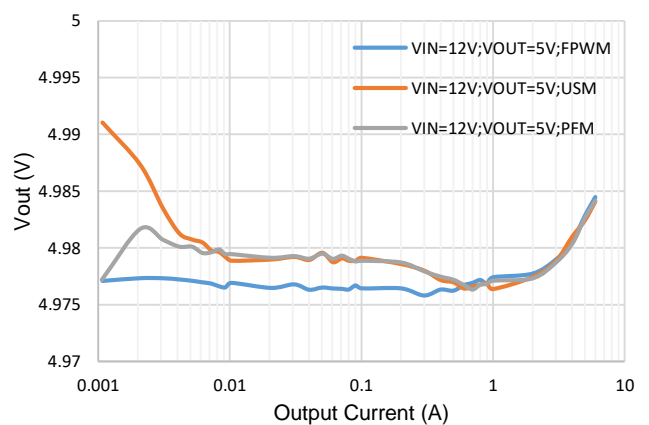

Figure 7. Load Regulation, Vout=5V, fsw=800kHz

FUNCTIONAL BLOCK DIAGRAM

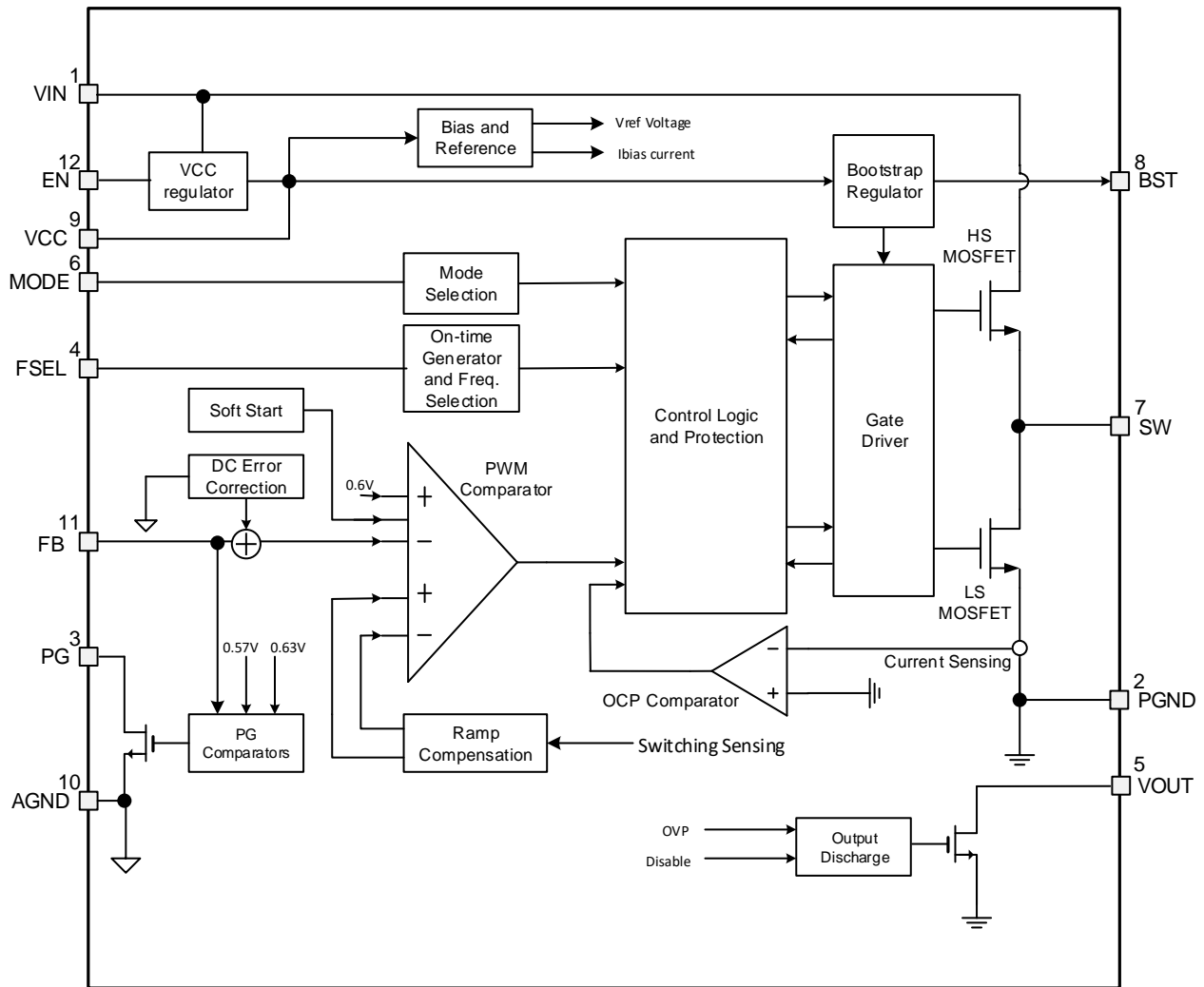

Figure 8. Functional Block Diagram

OPERATION

Overview

The SCT2260C is a 4.5V-18V input, 6A continuous output synchronous buck converter with built-in 42mΩ R_{ds(on)} high-side and 17mΩ R_{ds(on)} low-side power MOSFETs. It implements the Constant on-time (COT) mode control to regulate output voltage, providing excellent line and load transient response and simplifying the external frequency compensation design.

The switching frequency is selectable, 400kHz, 800kHz and 1.2MHz, by setting different FSEL status, to optimize either the power efficiency or the external components' sizes. The SCT2260C features an internal 1ms soft-start time to avoid large inrush current and output voltage overshoot during startup. The device features three different operation modes at light loading: Pulse Frequency Modulation (PFM) mode, Ultra-Sonic Modulation (USM) mode and Force Pulse Width Modulation (FPWM) mode. The quiescent current is typically 140uA under no load and sleep mode condition to achieve high efficiency at light load.

The SCT2260C has a default input start-up voltage of 4.25V with 300mV hysteresis. The EN function features with a precision threshold that can be used to adjust the input voltage lockout thresholds with two external resistors to meet accurate higher UVLO system requirements. Floating EN pin enables the device with the internal pull-up current to the pin. Connecting EN pin to VIN with a 100kΩ resistor starts up the device automatically.

The SCT2260C full protection features include the input under-voltage lockout, the output over-voltage protection, over current protection with cycle-by-cycle current limiting and hiccup mode, output hard short protection and thermal shutdown protection.

Constant on-time (COT) Mode Control

The SCT2260C employs constant on-time (COT) Mode control providing fast transient with pseudo fixed switching frequency. At the beginning of each switching cycle, since the feedback voltage (VFB) is lower than the internal reference voltage (VREF), the high-side MOSFET (Q1) is turned on during one on-time and the inductor current rises to charge up the output voltage. The on-time is determined by the input voltage and output voltage. After the on-time, the Q1 turns off and the low-side MOSFET (Q2) turns on after dead time duration. The inductor current drops and the output capacitors are discharged. When the output voltage decreases and the VFB decreased below the VFB, the Q1 turns on during one on-time after another dead time duration. This repeats on cycle-by-cycle based.

The SCT2260C works with an internal compensation for optimizing the loop stability and transient response.

Pulse Frequency Modulation (PFM) and Ultra-sonic Modulation (USM) Modes

Grounding the MODE pin makes the SCT2260C works at Pulse Frequency Modulation (PFM) mode to improve the power efficiency in light load. As the output current decreases from heavy load condition, the inductor current is also reduced. If the output current is reduced enough, the valley of the inductor current reaches the zero level, which is the boundary between continuous conduction and discontinuous conduction modes. The low-side MOSFET is turned off when a zero inductor current is detected. As the load current further decreases the converter runs into discontinuous conduction mode. The on-time is kept the same as it is in continuous conduction mode. The off-time increases as it takes more time to discharge the output with a smaller load current.

Floating the MODE pin makes the device works at PFM with Ultra-Sonic Modulation (USM) mode to keep the switching frequency out of the acoustic audible frequency. The USM mode block monitors the state of both high-side and low-side MOSFETs. When both high-side and low-side MOSFETs are off for 33us, the low-side MOSFET forces to turn on until the negative current limit is triggered or the feedback voltage (VFB) drops below the internal reference voltage (VREF).

Forced Pulse Width Modulation (PWM) mode

Connecting MODE pin to VCC, the SCT2260C forces the device operating at Forced Pulse Width Modulation (FPWM) mode with pseudo-fixed switching frequency regardless loading current. Operating in PWM mode can achieve smaller output voltage ripple compared with PFM or USM at light load. When the load current approaches

zero, the low-side MOSFET current crosses zero and sinks current from output to maintain the constant output. Hence power efficiency in light load is much lower than heavy load.

Enable and Under Voltage Lockout Threshold

The SCT2260C is enabled when the VIN pin voltage rises above 4.5V and the EN pin voltage exceeds the enable threshold of 1.18V. The device is disabled when the VIN pin voltage falls below 4V or when the EN pin voltage is below 1.1V. An internal 1.5uA pull up current source to EN pin allows the device enable when EN pin floats.

EN pin is a high voltage pin that can be connected to VIN directly to start up the device.

For a higher system UVLO threshold, connect an external resistor divider (R1 and R2) shown in Figure 9 from VIN to EN. The UVLO rising and falling threshold can be calculated by Equation 1 and Equation 2 respectively.

$$V_{\text{rise}} = 1.18 * \left(1 + \frac{R1}{R2}\right) - 1.5\mu\text{A} * R1 \quad (1)$$

$$V_{\text{fall}} = 1.1 * \left(1 + \frac{R1}{R2}\right) - 5.5\mu\text{A} * R1 \quad (2)$$

where

- V_{rise} is rising threshold of Vin UVLO
- V_{fall} is falling threshold of Vin UVLO

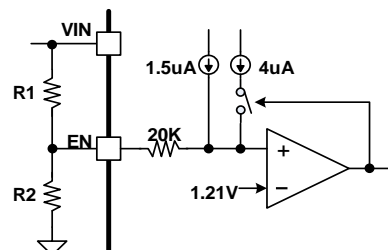

Figure 9. System UVLO by enable divide

Output Voltage

The SCT2260C regulates the internal reference voltage at 0.6V with $\pm 1\%$ tolerance over the operating temperature and voltage range. The output voltage is set by a resistor divider from the output node to the FB pin. It is recommended to use 1% tolerance or better resistors. Use Equation 3 to calculate resistance of resistor dividers. To improve efficiency at light loads, larger value resistors are recommended. However, if the values are too high, the regulator will be more susceptible to noise affecting output voltage accuracy.

$$R_{FB_TOP} = \left(\frac{V_{OUT}}{V_{REF}} - 1\right) * R_{FB_BOT} \quad (3)$$

where

- R_{FB_TOP} is the resistor connecting the output to the FB pin.
- R_{FB_BOT} is the resistor connecting the FB pin to the ground.

Internal Soft-Start

The SCT2260C integrates an internal soft-start circuit that ramps the reference voltage from zero volts to 0.6V reference voltage in 1ms. If the EN pin is pulled below 1.19V, switching stops and the internal soft-start resets. The soft-start also resets during shutdown due to thermal overloading.

Switching Frequency Selection

The switching frequency of the SCT2260C is selectable to be one of three options: 400KHz, 800KHz and 1200KHz. The switching frequency selection is programmed by FSEL pin. The selection information is shown in following table. The frequency setting is latched in at each power up and is not able to be modified during operation. Cycling the input power or the EN pin can reselect the switching frequency

SCT2260C

Table 1. FSEL Pin Set-up for Switching Frequency Selection

FSEL Set-up	Connect to GND	Floating	Connect to VCC
Switching Frequency	400KHz	800KHz	1200KHz

Mode Selection

The SCT2260C features two different operation modes at light load by easily programming the MODE pin. The programming information is listed in following table. The mode setting is latched in at each power up and is not be able to be modified during operation. Cycling the input power or the EN pin can reselect the switching frequency.

Table 2. MODE Pin Set-up for Mode Selection

MODE Set-up	Connect to VCC	Floating	Connect to GND
Switching Frequency	PWM	PFM with USM	PFM

Power Good (PG)

The Power Good (PG) pin is the output of an open drain output. When the FB pin is typically between 95% and 105% of the internal reference voltage (VREF) the PG is de-asserted and floats after a 500 μ s de-glitch time. A pull-up resistor of 10 k Ω to 100 k Ω is recommended to pull it up to VCC. The PGOOD pin is pulled low when the FB pin voltage is lower than Vout UVP or greater than Vout OVP threshold; or, in an event of thermal shutdown or during the soft-start period.

Bootstrap Voltage Regulator

An external bootstrap capacitor between BOOT pin and SW pin powers the floating gate driver to high-side power MOSFET. The bootstrap capacitor voltage is charged from 5V VCC power or when high-side power MOSFET is off and low-side power MOSFET is on.

Over Current Limit and Hiccup Mode

The output over-current limit (OCL) is implemented in SCT2260C by using a cycle-by-cycle valley detect control circuit. The switch current is monitored during the OFF state of the high-side FET (Q1) by measuring the low-side FET(Q2) drain to source voltage. This voltage is proportional to the switch current. During the on time of the high-side FET switch, the switch current increases at a linear rate determined by input voltage, output voltage, the on-time and the output inductor value. During the on time of the low-side FET switch, this current decrease linearly. The average value of the switch current is the load current IOUT.

If the measured drain to source voltage of the low-side FET is above the voltage proportional to current limit, the low side FET stays on until the current level becomes lower than the OCL level which reduces the output current available. In this type of valley detect control the load current is higher than the OCL threshold by one half of the peak to peak inductor ripple current. When the current is limited, the output voltage tends to drop because the load demand is higher than what the converter can support. After soft start end with 1ms waiting time, when the output voltage falls below 75% of the target voltage, the UVP comparator detects it and shuts down the device immediately, the device re-starts after a hiccup time of 7ms. When the overcurrent condition is removed, the output voltage returns to the regulated value.

The hiccup protection mode above makes the average short circuit current lower to alleviate thermal issues and protect the regulator.

Under voltage Protection

The SCT2260C features the Under-voltage Protection (UVP) by monitoring the output voltage to detect the under-voltage voltage. When the feedback voltage falls below 75% of VREF, the SCT2260C enters hiccup mode until the under-voltage scenario released.

Thermal Shutdown

The SCT2260C protects the device from the damage during excessive heat and power dissipation conditions. Once the junction temperature exceeds 150C, the internal thermal sensor stops power MOSFETs switching. When the junction temperature falls below 125C, the device restarts with internal soft start phase.

SCT2260C

APPLICATION INFORMATION

Typical Application

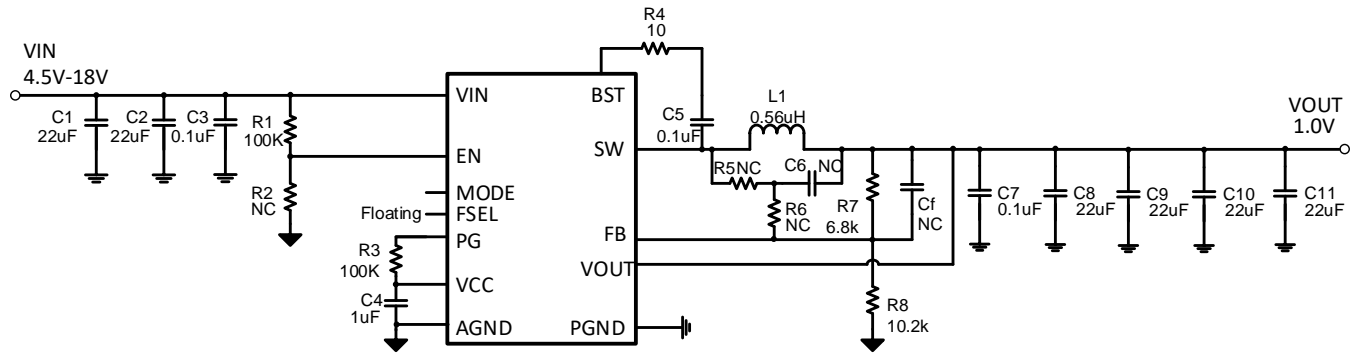

Figure 10. SCT2260C Design Example, 1.0V Output

Design Parameters

Design Parameters	Example Value
Input Voltage	12V Normal 4.5V to 18V
Output Voltage	1.0V
Maximum Output Current	6 A
Switching Frequency	800 KHz
Output voltage ripple (peak to peak)	40mV

Input Capacitor Selection

For good input voltage filtering, choose low-ESR ceramic capacitors. A ceramic capacitor 10 μ F is recommended for the decoupling capacitor and a 0.1 μ F ceramic bypass capacitor is recommended to be placed as close as possible to the VIN pin of the SCT2260C.

Use Equation 4 to calculate the input voltage ripple:

$$\Delta V_{IN} = \frac{I_{OUT}}{C_{IN} \times f_{SW}} \times \frac{V_{OUT}}{V_{IN}} \times \left(1 - \frac{V_{OUT}}{V_{IN}}\right) \quad (4)$$

Where:

- C_{IN} is the input capacitor value
- f_{sw} is the converter switching frequency
- I_{OUT} is the maximum load current

Due to the inductor current ripple, the input voltage changes if there is parasitic inductance and resistance between the power supply and the VIN pin. It is recommended to have enough input capacitance to make the input voltage ripple less than 100mV. Generally, two 25V/22 μ F input ceramic capacitors are recommended for most of applications. Choose the right capacitor value carefully with considering high-capacitance ceramic capacitors DC bias effect, which has a strong influence on the final effective capacitance.

Inductor Selection

The performance of inductor affects the power supply's steady state operation, transient behavior, loop stability, and buck converter efficiency. The inductor value, DC resistance (DCR), and saturation current influences both efficiency and the magnitude of the output voltage ripple. Larger inductance value reduces inductor current ripple and therefore leads to lower output voltage ripple. For a fixed DCR, a larger value inductor yields higher efficiency via reduced RMS and core losses. However, a larger inductor within a given inductor family will generally have a greater series resistance, thereby counteracting this efficiency advantage.

Inductor values can have $\pm 20\%$ or even $\pm 30\%$ tolerance with no current bias. When the inductor current approaches saturation level, its inductance can decrease 20% to 35% from the value at 0-A current depending on how the inductor vendor defines saturation. When selecting an inductor, choose its rated current especially the saturation current larger than its peak current during the operation.

To calculate the current in the worst case, use the maximum input voltage, minimum output voltage, maximum load current and minimum switching frequency of the application, while considering the inductance with -30% tolerance and low-power conversion efficiency.

For a buck converter, calculate the inductor minimum value as shown in equation 5.

$$L_{INDMIN} = \frac{V_{OUT} \times (V_{INMAX} - V_{OUT})}{V_{INMAX} \times K_{IND} \times I_{OUT} \times f_{SW}} \quad (5)$$

Where:

- K_{IND} is the coefficient of inductor ripple current relative to the maximum output current.

Therefore, the peak switching current of inductor, I_{LPEAK} , is calculated as in equation 6.

$$I_{LPEAK} = I_{OUT} + K_{IND} \times \frac{I_{OUT}}{2} \quad (6)$$

Set the current limit of the SCT2260C higher than the peak current I_{LPEAK} and select the inductor with the saturation current higher than the current limit. The inductor's DC resistance (DCR) and the core loss significantly affect the efficiency of power conversion. Core loss is related to the core material and different inductors have different core loss. For a certain inductor, larger current ripple generates higher DCR and ESR conduction losses and higher core loss.

Output Capacitor Selection

The selection of output capacitor will affect output voltage ripple in steady state and load transient performance.

The output ripple is essentially composed of two parts. One is caused by the inductor current ripple going through the Equivalent Series Resistance ESR of the output capacitors and the other is caused by the inductor current ripple charging and discharging the output capacitors. To achieve small output voltage ripple, choose a low-ESR output capacitor like ceramic capacitor. For ceramic capacitors, the capacitance dominates the output ripple. For simplification, the output voltage ripple can be estimated by Equation 7 desired.

$$\Delta V_{OUT} = \frac{V_{OUT} * (V_{IN} - V_{OUT})}{8 * f_{SW}^2 * L * C_{OUT} * V_{IN}} \quad (7)$$

Where

- ΔV_{OUT} is the output voltage ripple
- f_{SW} is the switching frequency
- L is the inductance of inductor
- C_{OUT} is the output capacitance
- V_{OUT} is the output voltage
- V_{IN} is the input voltage

Due to capacitor's degrading under DC bias, the bias voltage can significantly reduce capacitance. Ceramic capacitors can lose most of their capacitance at rated voltage. Therefore, leave margin on the voltage rating to ensure adequate effective capacitance. Typically, four 22 μ F ceramic output capacitors work for most applications.

Output Feedback Resistor Divider Selection

The SCT2260C features external programmable output voltage by using a resistor divider network R1 and R2 as shown in the typical application circuit Figure10. Use equation 8 to calculate the resistor divider values.

$$R_1 = \frac{(V_{OUT} - V_{ref}) \times R_2}{V_{ref}} \quad (8)$$

Table 3 Recommended Component Values for Typical Output Voltage (Vin=12V)

Fsw (kHz)	Vout (V)	L (uH)	R7 (k Ω)	R8 (k Ω)	Cf (pF)
400	1.0	0.68	6.8	10.2	N/A
	3.3	2.2	45.9	10.2	100
	5.0	3.3	75.0	10.2	220
800	1.0	0.56	6.8	10.2	N/A
	3.3	1.5	45.9	10.2	100
	5.0	2.2	75.0	10.2	220
1200	1.0	0.47	6.8	10.2	N/A
	3.3	1.2	45.9	10.2	100
	5.0	1.5	75.0	10.2	220

Application Waveforms

Unless otherwise noted, the following conditions are VIN=12V, VOUT=1V, Temperature=25C.

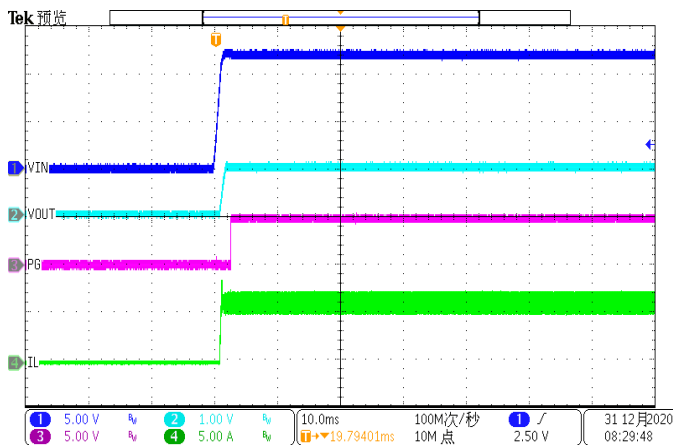

Figure 11. Power up

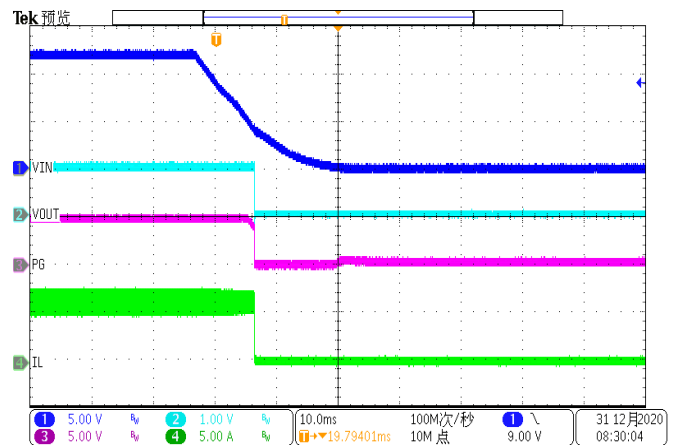

Figure 12. Power down

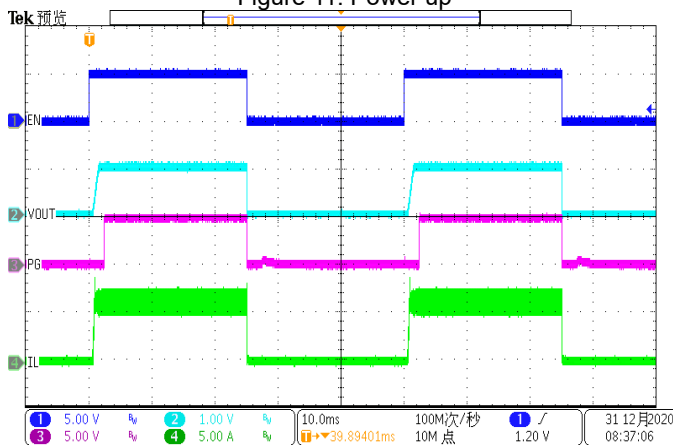

Figure 13. EN toggle (Iload=6A)

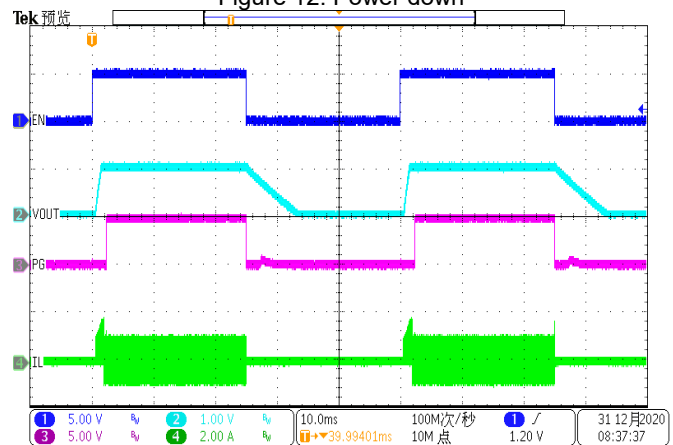

Figure 14. EN toggle (Iload=10mA)

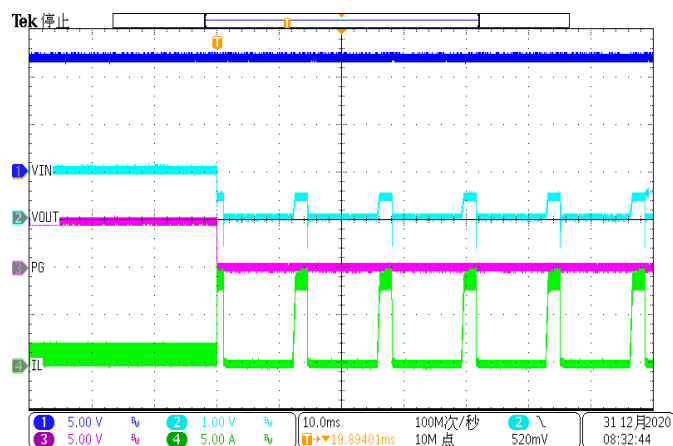

Figure 15. Over Current Protection(1A to hard short)

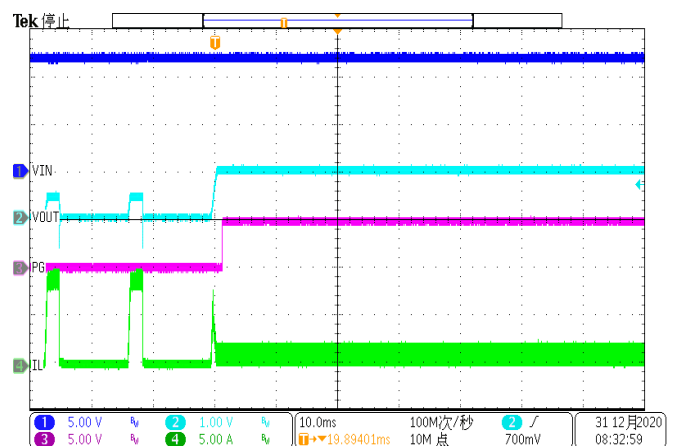

Figure 16. Over Current Release (hard short to 1A)

Application Waveforms(Continued)

Unless otherwise noted, the following conditions are VIN=12V, VOUT=1V, Temperature=25C.

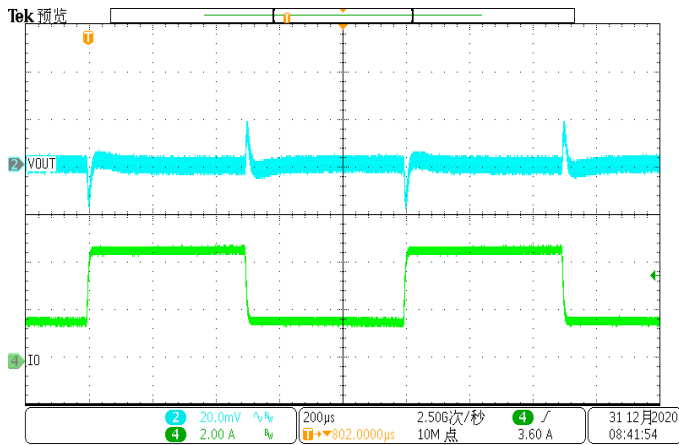

Figure 17. Load Transient (1.5A-4.5A, 1.6A/us)

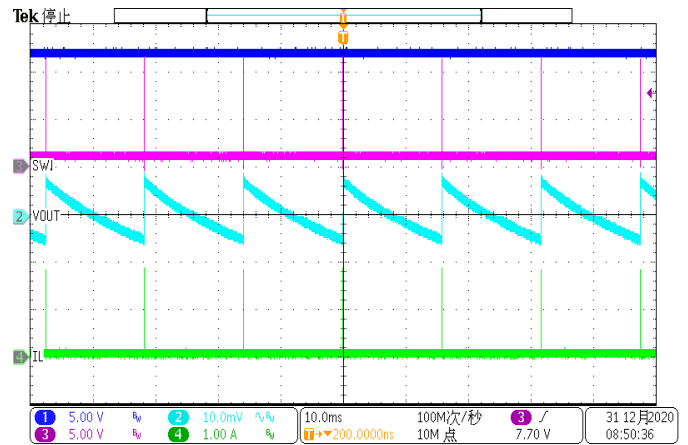

Figure 18. Output Ripple (Iload=0A, PFM)

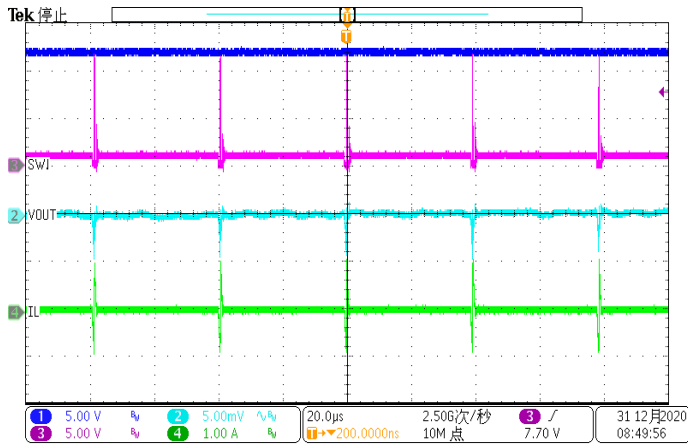

Figure 19. Output Ripple (Iload=0A, USM)

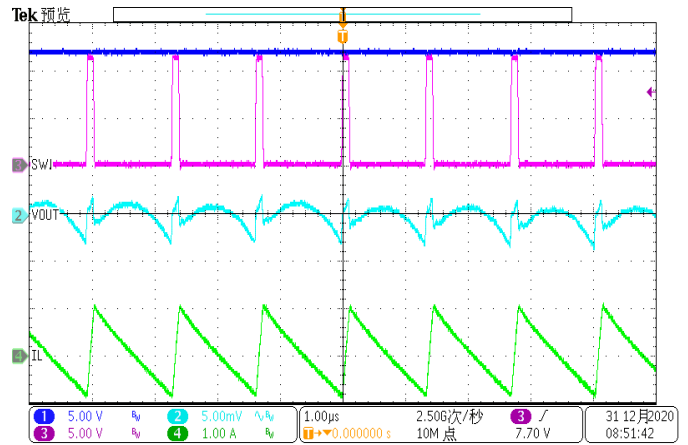

Figure 20. Output Ripple (Iload=0A, FPWM)

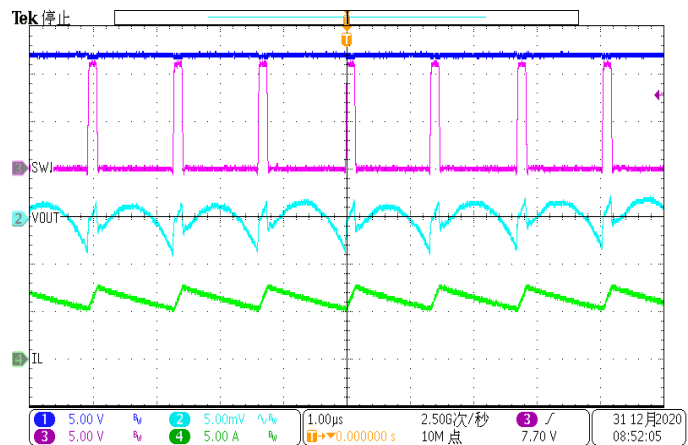

Figure 21. Output Ripple (Iload=6A)

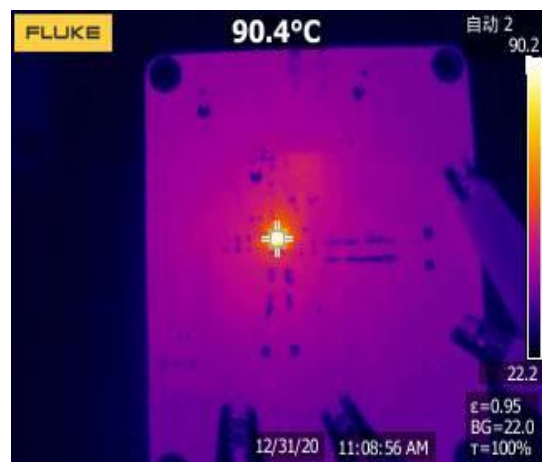

Figure 22. Thermal, 12 VIN, 1 Vout, 6A

Layout Guideline

Proper PCB layout is a critical for SCT2260C's stable and efficient operation. The traces conducting fast switching currents or voltages are easy to interact with stray inductance and parasitic capacitance to generate noise and degrade performance. For better results, follow these guidelines as below:

1. Place a low ESR ceramic capacitor as close to VIN pin and the ground as possible to reduce parasitic effect.
2. For operation at full rated load, the top side ground area must provide adequate heat dissipating area. Make sure top switching loop with power have lower impedance of grounding.
3. The bottom layer is a large ground plane connected to the ground plane on top layer by vias. it is recommended 8mil diameter drill holes of thermal vias, but a smaller via offers less risk of solder volume loss. On applications where solder volume loss thru the vias is of concern, plugging or tenting can be used to achieve a repeatable process.
4. Output inductor should be placed close to the SW pin. The area of the PCB conductor minimized to prevent excessive capacitive coupling.
5. UVLO adjust and loop compensation and feedback components should connect to small signal ground which must return to the GND pin without any interleaving with power ground.
6. Route BST resistor and capacitor with a minimized length between the BST PIN and SW PIN.

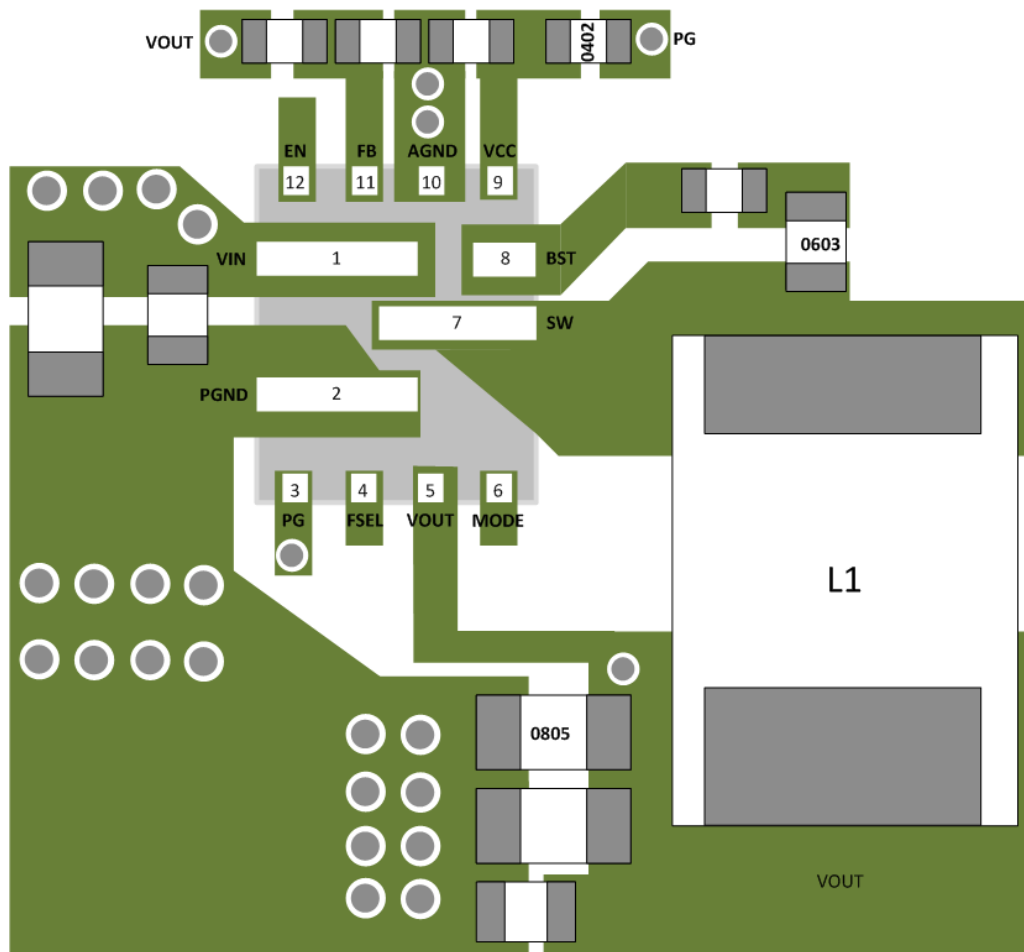
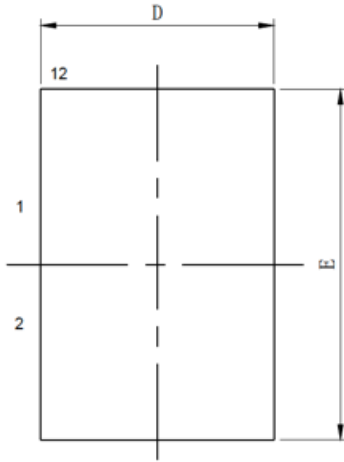

Figure 23. PCB Layout Example

SCT2260C

PACKAGE INFORMATION



TOP VIEW

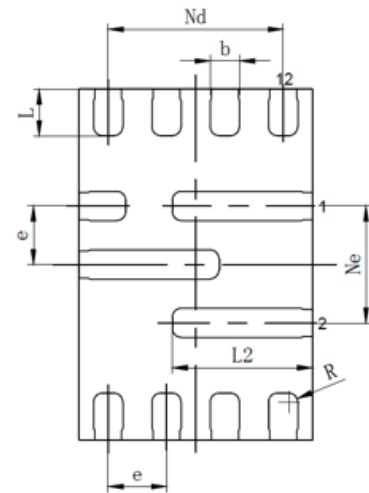

BOTTOM VIEW

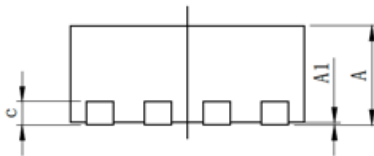

SIDE VIEW

SYMBOL	MILLIMETER		
	MIN	NOM	MAX
A	0.80	0.85	0.90
A1	0	0.02	0.05
b	0.20	0.25	0.30
c	0.15	0.20	0.25
D	1.95	2.00	2.05
e	0.50BSC		
Nd	1.50BSC		
Ne	1.00BSC		
E	2.95	3.00	3.05
L	0.35	0.40	0.45
L2	1.15	1.20	1.25
R	0.075REF		

NOTE:

1. Drawing proposed to be made a JEDEC package outline MO-220 variation.
2. Drawing not to scale.
3. Thermal pad shall be soldered on the board.
4. Dimensions of exposed pad on bottom of package do not include mold flash.
5. Contact PCB board fabrication for minimum solder mask web tolerances between the pins.

TAPE AND REEL INFORMATION

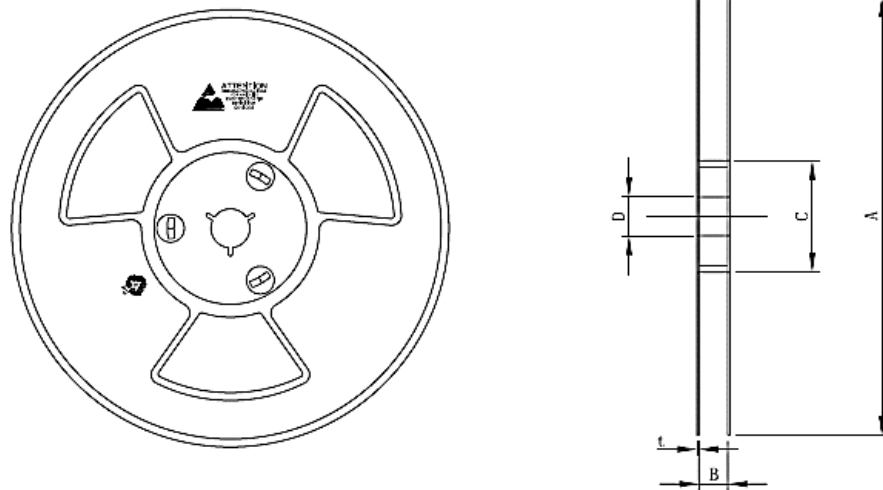

SYMBOL	MILLIMETER		
	MIN	NOM	MAX
A	328	329	330
B	11.80	12.80	13.80
C	99	100	101
D	13.00	13.30	13.60
t	1.70	2.00	2.30

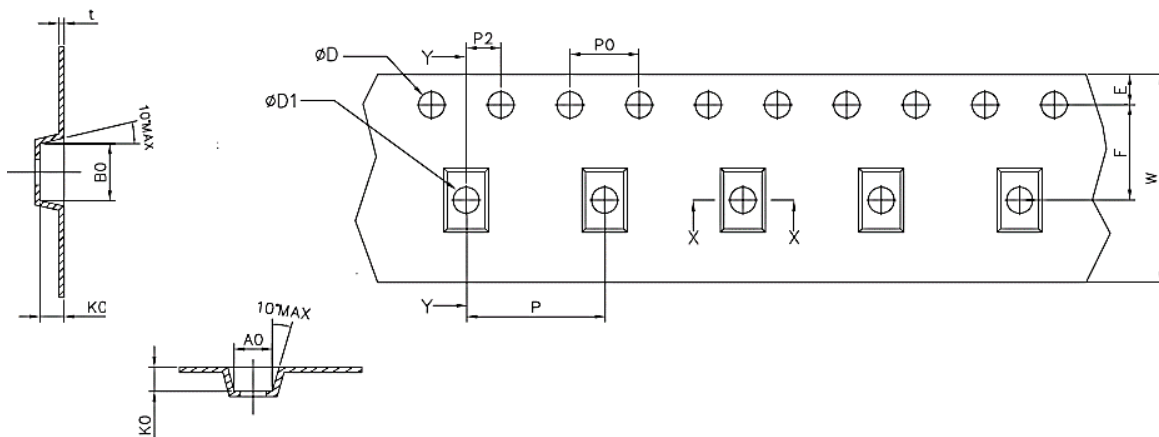

SYMBOL	MILLIMETER		
	MIN	NOM	MAX
E	1.65	1.75	1.85
F	5.45	5.50	5.55
P2	1.95	2.00	2.05
D		1.50	1.60
D1		1.50	1.75
P0	3.90	4.00	4.10
W	11.90	12.00	12.30
P	7.90	8.00	8.10
A0	2.10	2.20	2.30
B0	3.20	3.30	3.40
K0	1.04	1.14	1.24
t	0.23	0.25	0.27