

## 12.6V, 7A Fully Integrated High Efficiency Synchronous Boost Converter

### FEATURES

- Wide Input Voltage Range: 2.7V-12V
- Wide Output Voltage Range: 4.5V-12.6V
- Fully Integrated 17mΩ High Side FET and 14mΩ Low Side FET
- Up to 93% Efficiency at Vin=3.3V, Vout=9V, and Iout=2A
- Programmable and Up to 9.5A Peak Switch Current Limit
- Typical Shut-down Current: 1uA
- Adjustable Switching Frequency: 200KHz to 2.2MHz
- Forced PWM Operation Mode at Light Load
- Internal Soft Start and External Compensation
- Cycle-by-Cycle Overcurrent Protection
- Output Overvoltage Protection
- Thermal Shutdown Protection: 160°C
- QFN-11 2mm x 2.5mm Package

### APPLICATIONS

- Bluetooth Speaker
- Portable POS Terminal
- Quick Charge Power Bank
- E-Cigarette
- Outdoor Flashlight

### DESCRIPTION

The SCT1270F is a high efficiency synchronous boost converter with fully integrated a 17mΩ high-side MOSFET and a 14mΩ low-side MOSFET, featuring 2.7V to 12V input voltage range to support single cell or two cell Lithium ion/polymer batteries and up to 9.5A peak switch current. The switch current limit can be adjustable with an external resistor. The SCT1270F has 7A continuous switch current capability and provides output voltage up to 12.6V.

The SCT1270F adopts constant off-time peak current control to provide fast transient response. An external compensation network allows flexibility setting loop dynamics to achieve optimal transient performance at different load conditions.

The SCT1270F works in the PWM at moderate and heavy load condition and also works in the PWM mode at light load to avoid application problems caused by low switching frequency. The switching frequency is adjustable from 200KHz to 2.2MHz.

The SCT1270F features output overvoltage protection and thermal shutdown protection when the device over loads.

The device is available in a QFN-11 2mm x 2.5mm package.

### TYPICAL APPLICATION

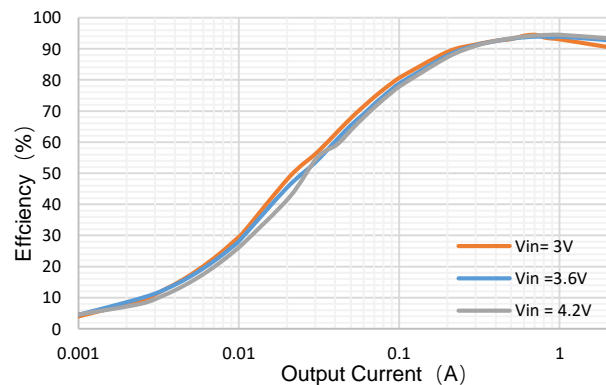
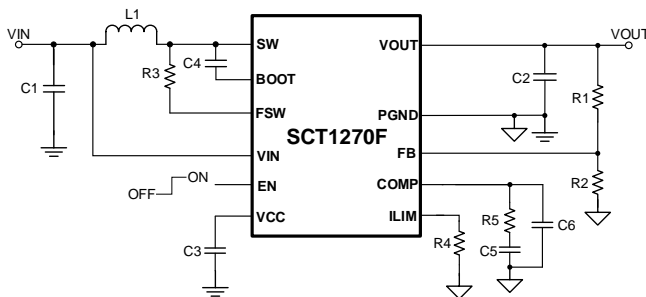

Efficiency vs Load Current, Vout=9V

# SCT1270F

## REVISION HISTORY

NOTE: Page numbers for previous revisions may differ from page numbers in the current version.

Revision 1.0: Production

Revision 1.1: Update T<sub>J</sub> to 150 °C

## DEVICE ORDER INFORMATION

PART NUMBER	PACKAGE MARKING	PACKAGE DISCRIPTION
SCT1270FFQA	270F	11-Lead 2mmx2.5mm Plastic QFN

1) For Tape & Reel, Add Suffix R (e.g. SCT1270FFQAR)

## ABSOLUTE MAXIMUM RATINGS

Over operating free-air temperature unless otherwise noted<sup>(1)</sup>

DESCRIPTION	MIN	MAX	UNIT
BOOT	-0.3	21.5	V
VIN, SW, FSW, VOUT	-0.3	14.5	V
SW (<20ns)	-1.5	16.5	V
VCC, LIM, FB, EN, COMP, MODE	-0.3	5.5	V
BOOT-SW	-0.3	5.5	V
Operating ambient temperature T <sub>A</sub>	-40	125	°C
Operating junction temperature T <sub>J</sub> <sup>(2)</sup>	-40	150	°C
Storage temperature T <sub>STG</sub>	-65	150	°C

- (1) Stresses beyond those listed under Absolute Maximum Rating may cause device permanent damage. The device is not guaranteed to function outside of its Recommended Operation Conditions.
- (2) The IC includes over temperature protection to protect the device during overload conditions. Junction temperature will exceed 150°C when over temperature protection is active. Continuous operation above the specified maximum operating junction temperature will reduce lifetime

## PIN CONFIGURATION

Top View: 11-Lead Plastic QFN 2mm x 2.5mm

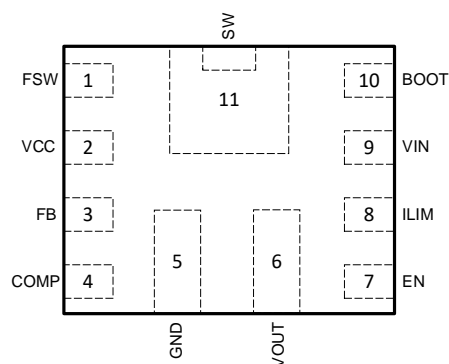

## PIN FUNCTIONS

NAME	NO.	PIN FUNCTION
FSW	1	Place a resistor from this pin to SW to sets the switching frequency.
VCC	2	Internal linear regulator output. Connect a 1uF or larger ceramic capacitor to ground. VCC can not to be externally driven. No additional components or loading is recommended on this pin.
FB	3	Feedback Input. Connect a resistor divider from VOUT to FB to set up output voltage.
COMP	4	Output of the error amplifier and switching converter loop compensation point.
GND	5	Ground
VOUT	6	Boost converter output. Connect a 1uF decoupling capacitor as close to VOUT pins and power ground pad as possible to reduce the ringing voltage of SW.
EN	7	Enable logic input. An 750KΩ resistor connects this pin to ground inside. Floating disables the device.

ILIM	8	Inductor peak current limit set point input. A resistor connecting this pin to ground sets current limit through low-side power FET.
VIN	9	Power supply input. Must be locally bypassed with a capacitor as close as possible to the pin.
BOOT	10	Power supply for the high-side power MOSFET gate driver. Must connect a 0.1uF or greater ceramic capacitor between BOOT pin and SW node.
SW	11	Switching node of the boost converter.

## RECOMMENDED OPERATING CONDITIONS

Over operating free-air temperature range unless otherwise noted

PARAMETER	DEFINITION	MIN	MAX	UNIT
V <sub>IN</sub>	Input voltage range	2.7	12	V
V <sub>OUT</sub>	Output voltage range	4.5	12.6	V
T <sub>J</sub>	Operating junction temperature	-40	150	°C

## ESD RATINGS

PARAMETER	DEFINITION	MIN	MAX	UNIT
V <sub>ESD</sub>	Human Body Model(HBM), per ANSI-JEDEC-JS-001-2014 specification, all pins <sup>(1)</sup>	-2	+2	kV
	Charged Device Model(CDM), per ANSI-JEDEC-JS-002-2014specification, all pins <sup>(2)</sup>	-0.5	+0.5	kV

(1) HBM and CDM stressing are done in accordance with the ANSI/ESDA/JEDEC JS-001-2014 specification

## THERMAL INFORMATION

PARAMETER	THERMAL METRIC	QFN-11L	UNIT
R <sub>θJA</sub>	Junction to ambient thermal resistance <sup>(1)</sup>	53.4	°C/W
R <sub>θJC</sub>	Junction to case thermal resistance <sup>(1)</sup>	59.2	

(1) SCT provides R<sub>θJA</sub> and R<sub>θJC</sub> numbers only as reference to estimate junction temperatures of the devices. R<sub>θJA</sub> and R<sub>θJC</sub> are not a characteristic of package itself, but of many other system level characteristics such as the design and layout of the printed circuit board (PCB) on which the SCT1270F is mounted, thermal pad size, and external environmental factors. The PCB board is a heat sink that is soldered to the leads and thermal pad of the SCT1270F. Changing the design or configuration of the PCB board changes the efficiency of the heat sink and therefore the actual R<sub>θJA</sub> and R<sub>θJC</sub>.

# SCT1270F

## ELECTRICAL CHARACTERISTICS

$V_{IN}=3.6V$ ,  $T_J=-40^{\circ}C\sim 125^{\circ}C$ , typical values are tested under  $25^{\circ}C$ .

SYMBOL	PARAMETER	TEST CONDITION	MIN	TYP	MAX	UNIT
<b>Power Supply and Output</b>						
$V_{IN}$	Operating input voltage		2.7		12	V
$V_{OUT}$	Output voltage range		4.5		12.6	V
$V_{IN\_UVLO}$	Input UVLO Hysteresis	$V_{IN}$ rising		2.5 200		V mV
$I_{SD}$	Shutdown current	EN=0, no load and measured on $V_{IN}$ pin		1		$\mu A$
$I_Q$	Quiescent current from $V_{IN}$	EN=2V, no load, no switching		1.8		$\mu A$
	Quiescent current from $V_{OUT}$			450		$\mu A$
$V_{CC}$	Internal linear regulator	$I_{VCC}=5mA$ , $V_{IN}=6V$		4.75		V
$V_{CC\_UVLO}$	VCC UVLO threshold	$V_{IN}$ falling		2.2		V
<b>Reference and Control Loop</b>						
$V_{REF}$	Reference voltage of FB		0.98	1	1.02	V
$I_{FB}$	FB pin leakage current	$V_{FB}=1V$			100	nA
$G_{EA}$	Error amplifier trans-conductance	$V_{COMP}=1.5V$		200		$\mu S$
$I_{COMP\_SRC}$	Error amplifier maximum source current	$V_{FB}=V_{REF}-200mV$ , $V_{COMP}=1.5V$		24		$\mu A$
$I_{COMP\_SNK}$	Error amplifier maximum sink current	$V_{FB}=V_{REF}+200mV$ , $V_{COMP}=1.5V$		24		$\mu A$
$V_{COMP\_H}$	COMP high clamp	$V_{FB}=0.8V$ , $R_{ILIM}=100k\Omega$		2.2		V
$V_{COMP\_L}$	COMP low clamp	$V_{FB}=1.2V$ , $R_{ILIM}=100k\Omega$ , PFM		0.9		V
<b>Power MOSFETs</b>						
$R_{DS(on)_H}$	High side FET on-resistance			17		$m\Omega$
$R_{DS(on)_L}$	Low side FET on-resistance			14		$m\Omega$
<b>Current Limit</b>						
$I_{LIM}$	Peak current limit	$R_{ILIM}=100k\Omega$	7.2	8	8.8	A
		$R_{ILIM}=84k\Omega$		9.5		A
<b>Enable</b>						
$V_{EN}$	Enable high threshold				1.2	V
	Enable low threshold		0.4			V
$R_{EN}$	Enable pull down resistance			750		$k\Omega$
$T_{SS}$	Soft-start Current			4		ms
<b>Switching Frequency</b>						
$F_{SW}$	Switching frequency	$R_{FSW}=308k\Omega$ , $V_{OUT}=12V$		500		kHz
$t_{ON\_MIN}$	Minimum on-time	$R_{FSW}=308k\Omega$ , $V_{OUT}=12V$		170		ns
<b>Protection</b>						
$V_{OVP\_VOUT}$	Output overvoltage threshold	$V_{OUT}$ rising		13.2		V
	Hysteresis			280		mV
$T_{SD}$	Thermal shutdown threshold	$T_J$ rising		164		$^{\circ}C$
	Hysteresis			24		$^{\circ}C$

\*Derived from bench characterization

**TYPICAL CHARACTERISTICS**

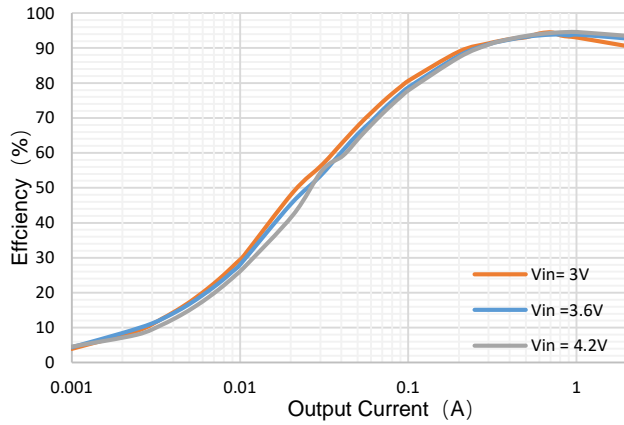

Figure 1. SCT1270F Efficiency vs Load Current, Vout=9V

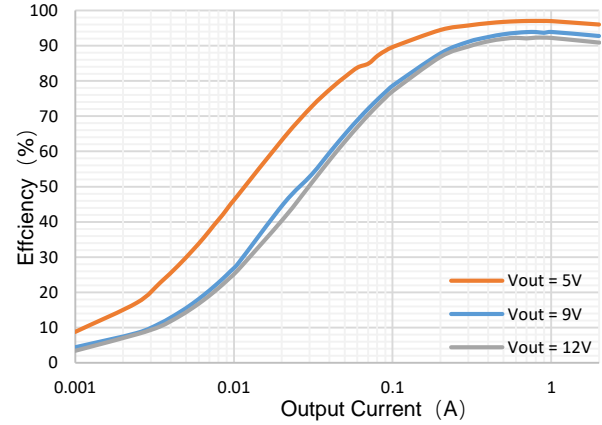

Figure 2. SCT1270F Efficiency vs Load Current, Vin=3.6V

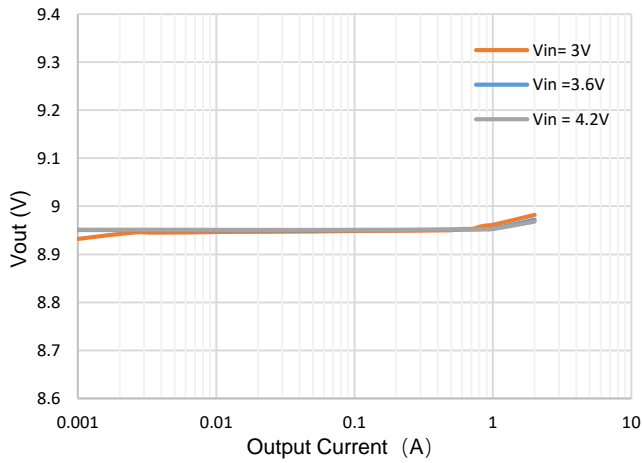

Figure 3. Load Regulation (Vin=3.6V, Vout=9V)

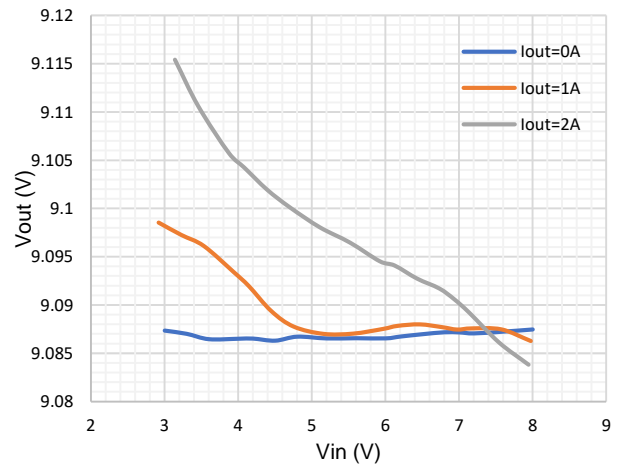

Figure 4. Line Regulation, Vout=9V

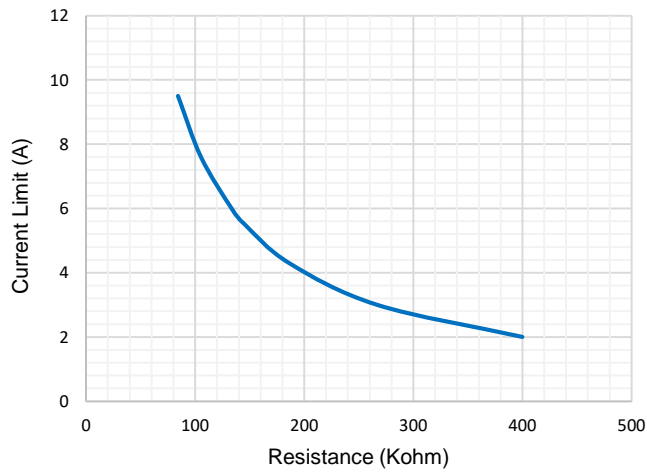

Figure 5. Current Limit VS Setting Resistance

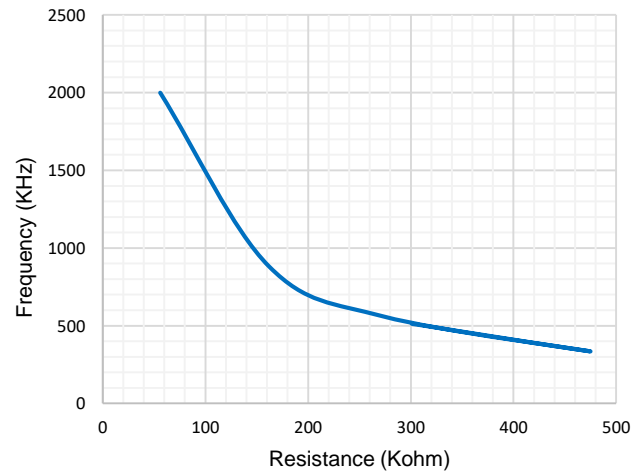

Figure 6. Switching Frequency VS Setting Resistance

## FUNCTIONAL BLOCK DIAGRAM

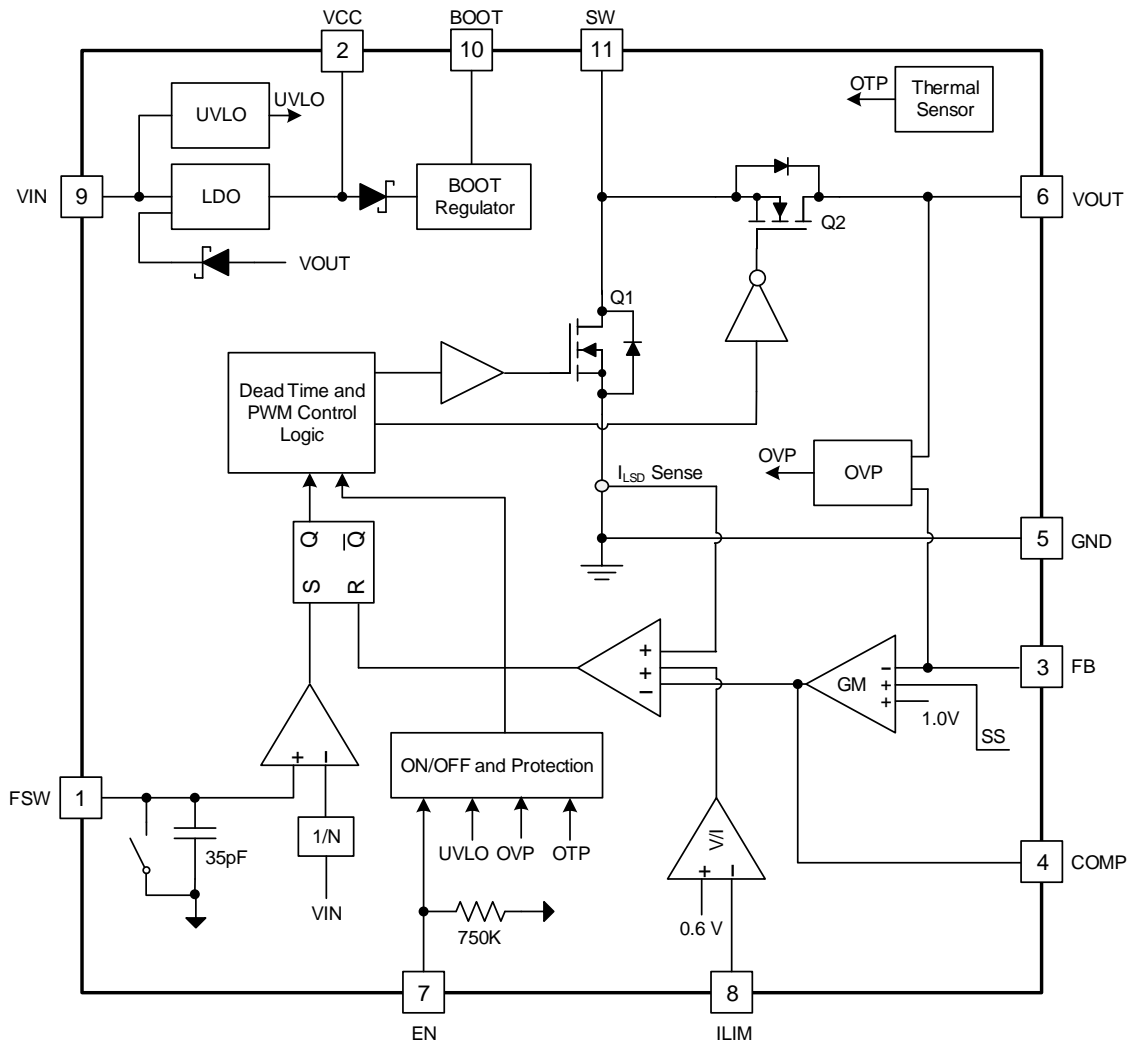

Figure 7. Functional Block Diagram

## OPERATION

### Overview

The SCT1270F device is a fully integrated synchronous boost converter, which regulates output voltage higher than input voltage. The constant off-time peak current mode control provides fast transient with pseudo fixed switching frequency. When low-side MOSFET Q1 turns on, input voltage forces the inductor current rise. Sensed voltage on low-side MOSFET peak current rises above the voltage determined by COMP. After the inductor current reaches the peak current, the device turns off low-side MOSFET and inductor goes through body diode of high-side MOSFET Q2 during dead time. After dead time duration, the device turns on high-side MOSFET Q2 and the inductor current decreases. Based on  $V_{in}$  and  $V_{out}$  voltage, the device predicts required off-time and turns off high-side MOSFET Q2. This repeats on cycle-by-cycle based.

The voltage feedback loop regulates the FB voltage to an internal voltage reference with an integrated trans-conductance error amplifier. The feedback loop stability and transient response are optimized through an external loop compensation network connected to the COMP pin.

The SCT1270F works at forced PWM mode which can avoid the acoustic noise and switching frequency interference at light load.

A resistor connected between SW pin and the FSW pin sets the switching frequency. The wide switching frequency range of 200 kHz to 2.2 MHz offers optimization on efficiency or size of filter components.

The SCT1270F device features internal soft-start, cycle-by-cycle low-side FET current limit, over-voltage protection, and over-temperature protection.

The SCT1270F uses the thermal pad as the power ground. Power ground must be connected to the thermal pad on the PCB at the closest point.

### VIN Power

The SCT1270F is designed to operate from an input voltage supply range between 2.7 V to 12V. If the input supply is located more than a few inches from the converter, additional bulk capacitance is required in addition to the ceramic bypass capacitors. A typical choice is ceramic capacitor with a value of 47 $\mu$ F or 2 x 22 $\mu$ F.

### VCC Power

The internal VCC LDO provides the bias power supply for internal circuitries. A ceramic capacitor of no less than 1 $\mu$ F is required to bypass from VCC pin to ground. During starting up, input of VCC LDO is from VIN pin. Once the output voltage at VOUT pin exceeds VIN voltage, VCC LDO switches its input to VOUT pin. This allows higher voltage headroom of VCC at lower input voltage. The maximum current capability of VCC LDO is 130mA typical. No additional components or loading are recommended on this pin.

### Under Voltage Lockout UVLO

The SCT1270F features UVLO protection for voltage rails of VIN, VCC and BOOT-SW from the converter malfunctioning and the battery over discharging. The default VIN rising threshold is 2.5V typical at startup and falling threshold is 2.3V typical at shutdown. The internal VCC LDO dropout voltage is about 100mV and the device is disabled when VCC falling trips 2.2V typical threshold. The internal charge pump from BOOT to SW powers the gate driver to high-side MOSFET Q2. The BOOT UVLO circuit monitors the capacitor voltage between BOOT pin and SW pin. When the voltage of BOOT to SW falls below a preset threshold 3V typical, high-side MOSFET Q2 turns off. As a result, the device works as a non-synchronous boost converter.

### Enable and Start-up

When applying a voltage higher than the EN high threshold (maximum 1.2V), the SCT1270F enables all functions and starts converter operation. To disable converter operation, EN voltage needs fall below its lower threshold (minimum 0.4V). An internal 750K $\Omega$  resistor connects EN pin to the ground. Floating EN pin automatically disables

# SCT1270F

---

the device.

The SCT1270F features fixed 4ms soft start to prevent inrush current during power-up.

## Adjustable Peak Current Limit

The SCT1270F boost converter implements cycle-by-cycle peak current limit function with sensing the internal low-side power MOSFET Q1 during overcurrent condition. While the Q1 is turned on, its conduction current is monitored by the internal sensing circuitry. Once the low-side MOSFET Q1 current exceeds the limit, it turns off immediately. An external resistor connecting ILIM pin to ground sets the low-side MOSFET Q1 peak current limit threshold. Use Equation 1 or Figure 5 to calculate the peak current limit.

$$I_{LIM}(A) = \frac{800}{R_{LIM}(k\Omega)} \quad (1)$$

where:

- $I_{LIM}$  is the peak current limit
- $R_{LIM}$  is the resistance between ILIM pin to ground.

This current limit function is realized by detecting the current flowing through the low-side MOSFET. The current limit feature loses function in the output hard short circuit conditions. At normal operation, when the output hard shorts to ground, there is a direct path to short the input voltage through high-side MOSFET Q2 or its body diode even the Q2 is turned off. This could damage the circuit components and cause catastrophic failure at load circuit.

## Adjustable Switching Frequency

The SCT1270F features a wide adjustable switching frequency ranging from 200kHz to 2.2MHz. The switching frequency is set by a resistor connected between the FSW pin and the SW pin of SCT1270F. Do not leave the FSW pin open. Use Equation 2 to calculate the resistor value required for a desired frequency.

$$R_{FREQ} = \frac{6 * \left( \frac{1}{f_{SW}} - T_{DELAY} * \frac{V_{OUT}}{V_{IN}} \right)}{C_{FREQ}} \quad (2)$$

where:

- $f_{SW}$  is the desired switching frequency
- $T_{DELAY} = 70$  ns
- $C_{FREQ} = 35$  pF
- $V_{IN}$  is the input voltage
- $V_{OUT}$  is the output voltage

## Over Voltage Protection and Minimum On-time

The SCT1270F features VOUT pin over voltage protection. If the VOUT pin is above 13.2V typical, the device stops switching immediately until the VOUT pin drops below 12.92V. The OVP function prevents the connected output circuitry from un-predictive overvoltage.

The low-side MOSFET has minimum on-time 170ns typical limitation. While the device is operating at minimum on time and further increasing  $V_{in}$  push output voltage beyond regulation point. With output and feedback over voltage protection, the converter skips pulse with turning off high-side MOSFET and prevents output running higher to damage the load.

## Forced PWM Mode

In the forced PWM mode, the SCT1270F keeps the switching frequency unchanged in light load condition. When the load current decreases, the output of the internal error amplifier decreases as well to keep the inductor peak current down, delivering less power from input to output. When the output current further reduces, the current through the inductor will decrease to zero during the off-time. The high-side N-MOSFET is not turned off even if the current through the MOSFET is zero. Thus, the inductor current changes its direction after it runs to zero. The power flow is from output side to input side. The efficiency will be low in this mode. But with the fixed switching frequency,



there is no audible noise and other problems which might be caused by low switching frequency in light load condition.

## **Thermal Shutdown**

Once the junction temperature in the SCT1270F exceeds 164 °C, the thermal sensing circuit stops switching until the junction temperature falling below 140 °C, and the device restarts. Thermal shutdown prevents the damage on device during excessive heat and power dissipation condition.

# SCT1270F

## APPLICATION INFORMATION

### Typical Application

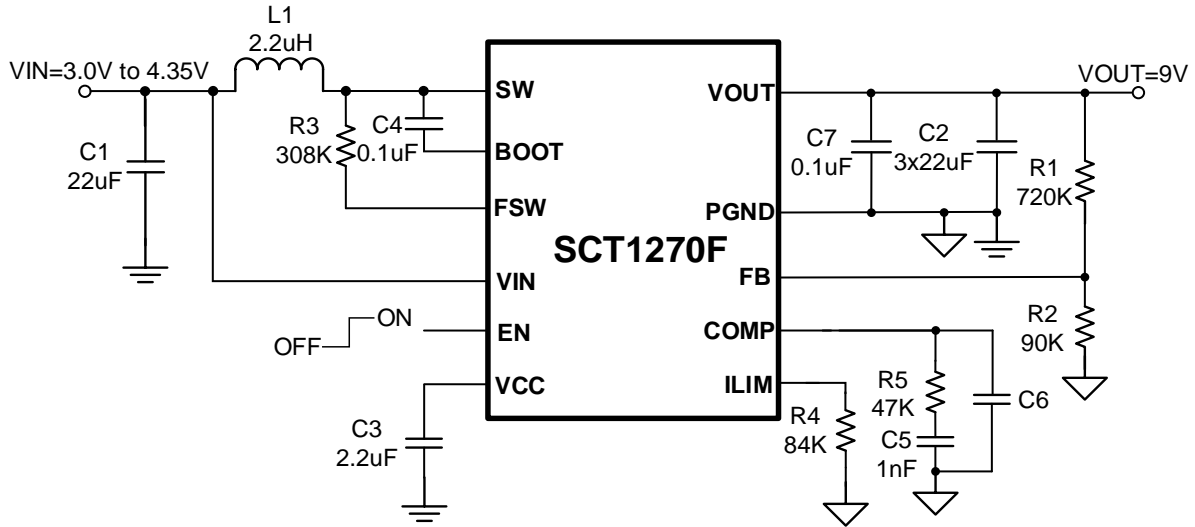

Figure 8. One Cell Battery Input, 9V/2A (20W) Output

#### Design Parameters

Design Parameters	Example Value
Input Voltage	3.0V to 4.35V
Output Voltage	9V
Output Current	2A
Output voltage ripple (peak to peak)	100mV
Switching Frequency	500 kHz
Operation Mode	Forced PWM

## Switching Frequency

The resistor connected from FSW to SW sets switching frequency of the converter. The resistor value required for a desired frequency can be calculated using equation 3. High frequency can reduce the inductor and output capacitor size with the tradeoff of more thermal dissipation and lower efficiency.

$$R_{FREQ} = \frac{6 * (\frac{1}{f_{SW}} - T_{DELAY} * \frac{V_{OUT}}{V_{IN}})}{C_{FREQ}} \quad (3)$$

where:

- $f_{SW}$  is the desired switching frequency
- $T_{DELAY} = 70 \text{ ns}$
- $C_{FREQ} = 35 \text{ pF}$
- $V_{IN}$  is the input voltage
- $V_{OUT}$  is the output voltage

**Table 1. R<sub>FSW</sub> Value for Common Switching Frequencies (Vin=3.6V, Vout=9V, Room Temperature)**

Fsw	R <sub>FREQ</sub>
200 KHz	830 KΩ
350 KHz	460 KΩ
520 KHz	300 KΩ
850 KHz	162 KΩ
1000 KHz	140 KΩ
2000 KHz	55 KΩ

## Peak Current Limit

Using the correct external resistor at ILIM pin sets the peak input current. Table 2 shows the resistor value for inductor peak current limit. For a typical current limit of 9.5A, the resistor value is 84KΩ. The minimum current limit must be higher than the required peak switch current at lowest input voltage and the highest output power not to hit the current limit and still regulate the output voltage.

$$I_{LIM}(A) = \frac{800}{R_{LIM}(k\Omega)} \quad (4)$$

where:

- $I_{LIM}$  is the peak current limit
- $R_{LIM}$  is the resistance of ILIM pin to ground

**Table 2. R<sub>LIM</sub> Value for Inductor Peak Current (Vin=3.6V, Vout=9V, L=2.2uH, Room Temperature)**

I <sub>LIM</sub>	R <sub>LIM</sub>
9.5 A	84 KΩ
8 A	100 KΩ
5.6A	142 KΩ
4A	200 KΩ

## Output Voltage

The output voltage is set by an external resistor divider R3 and R4 in typical application schematic. A minimum current of typical 20uA flowing through feedback resistor divider gives good accuracy and noise covering. The value of R3 can be calculated by equation 5.

$$R_1 = \frac{(V_{OUT} - V_{REF}) \times R_2}{V_{REF}} \quad (5)$$

where:

- $V_{REF}$  is the feedback reference voltage, typical 1.0V

**Table 3. Feedback Resistor R<sub>1</sub> R<sub>2</sub> Value for Output Voltage (Room Temperature)**

V <sub>OUT</sub>	R <sub>1</sub>	R <sub>2</sub>
5 V	360 KΩ	90 KΩ
9 V	720 KΩ	90 KΩ
12 V	990 KΩ	90 KΩ

## Inductor Selection

The performance of inductor affects the power supply's steady state operation, transient behavior, loop stability, and boost converter efficiency. The inductor value, DC resistance, and saturation current influences both efficiency and the magnitude of the output voltage ripple. Larger inductance value reduces inductor current ripple and therefore leads to lower output voltage ripple. For a fixed DC resistance, a larger value inductor yields higher efficiency via reduced RMS and core losses. However, a larger inductor within a given inductor family will generally have a greater series resistance, thereby counteracting this efficiency advantage.

Inductor values can have  $\pm 20\%$  or even  $\pm 30\%$  tolerance with no current bias. When the inductor current approaches saturation level, its inductance can decrease 20% to 35% from the value at 0-A current depending on how the inductor vendor defines saturation. When selecting an inductor, choose its rated current especially the saturation current larger than its peak current during the operation.

To calculate the current in the worst case, use the minimum input voltage, maximum output voltage, maximum load current and minimum switching frequency of the application, while considering the inductance with -30% tolerance and low-power conversion efficiency.

For a boost converter, calculate the inductor DC current as in equation 6

$$I_{LDC} = \frac{V_{OUT} \times I_{OUT}}{V_{IN} \times \eta} \quad (6)$$

Where

- $V_{OUT}$  is the output voltage of the boost converter
- $I_{OUT}$  is the output current of the boost converter
- $V_{IN}$  is the input voltage of the boost converter
- $\eta$  is the power conversion efficiency

Calculate the inductor current peak-to-peak ripple,  $I_{LPP}$ , as in equation 7

$$I_{LPP} = \frac{1}{L \times \left( \frac{1}{V_{OUT} - V_{IN}} + \frac{1}{V_{IN}} \right) \times f_{SW}} \quad (7)$$

Where

- $I_{LPP}$  is the inductor peak-to-peak current
- $L$  is the inductance of inductor
- $f_{SW}$  is the switching frequency
- $V_{OUT}$  is the output voltage
- $V_{IN}$  is the input voltage

Therefore, the peak switching current of inductor,  $I_{LPEAK}$ , is calculated as in equation 8.

$$I_{LPEAK} = I_{LDC} + \frac{I_{LPP}}{2} \quad (8)$$

Set the current limit of the SCT1270F higher than the peak current  $I_{LPEAK}$  and select the inductor with the saturation current higher than the current limit.

The inductor's DC resistance (DCR) and the core loss significantly affect the efficiency of power conversion. Core loss is related to the core material and different inductors have different core loss. For a certain inductor, larger current ripple generates higher DCR and ESR conduction losses and higher core loss. Usually, a data sheet of an inductor does not provide the ESR and core loss information. If needed, consult the inductor vendor for detailed information. There is a tradeoff among the inductor's inductance, DCR and ESR resistance, and its footprint. Shielded inductors typically have higher DCR than unshielded inductors. Table 4 lists recommended inductors for the SCT1270F. Verify whether the recommended inductor can support the user's target application with the previous

calculations and bench evaluation. In this application, the Würth-Elektronix 's inductor 744313220 is used on SCT1270F evaluation board.

**Table 4. Recommended Inductors**

Part Number	L (uH)	DCR Max (mΩ)	Saturation Current/Heat Rating Current (A)	Size Max (LxWxH mm)	Vendor
744325180	1.8	3.5	18 / 14	10.5 x 10.2 x 4.7	Würth Elektronik
744311150	1.5	7.2	14 / 11	7.3 x 7.2 x 4.0	Würth Elektronik
744311220	2.2	12.5	13 / 9	7.3 x 7.2 x 4.0	Würth Elektronik
744313220	2.2	5.7	18 / 14	12.9 x 12.8 x 3.3	Würth Elektronik
CDMC8D28NP-1R8MC	1.8	12.6	9.4 / 9.3	9.5 x 8.7 x 3.0	Sumida

## Input Capacitor Selection

For good input voltage filtering, choose low-ESR ceramic capacitors. A 0.1μF ceramic bypass capacitor is recommended to be placed as close as possible to the VIN pin of the SCT1270F. A ceramic capacitor of more than 1.0μF is required at the VCC pin to get a stable operation of the internal LDO.

For the power stage, because of the inductor current ripple, the input voltage changes if there is parasitic inductance and resistance between the power supply and the inductor. It is recommended to have enough input capacitance to make the input voltage ripple less than 100mV. Generally, 2x 22μF input capacitance is recommended for most applications. Choose the right capacitor value carefully by considering high-capacitance ceramic capacitors DC bias effect, which has a strong influence on the final effective capacitance.

## Output Capacitor Selection

For small output voltage ripple, choose a low-ESR output capacitor like a ceramic capacitor. Typically, three 22μF ceramic output capacitors work for most applications. Higher capacitor values can be used to improve the load transient response. Due to a capacitor's derating under DC bias, the bias can significantly reduce capacitance. Ceramic capacitors can lose most of their capacitance at rated voltage. Therefore, leave margin on the voltage rating to ensure adequate effective capacitance. From the required output voltage ripple, use the equation 9 and 10 to calculate the minimum required effective capacitance, C<sub>OUT</sub>.

$$V_{ripple\_C} = \frac{(V_{OUT} - V_{IN\_MIN}) \times I_{OUT}}{V_{OUT} \times f_{SW} \times C_{OUT}} \quad (9)$$

$$V_{ripple\_ESR} = I_{Lpeak} \times ESR \quad (10)$$

where

- V<sub>ripple\_C</sub> is output voltage ripple caused by charging and discharging of the output capacitor.
- V<sub>ripple\_ESR</sub> is output voltage ripple caused by ESR of the output capacitor.
- V<sub>IN\_MIN</sub> is the minimum input voltage of boost converter.
- V<sub>OUT</sub> is the output voltage.
- I<sub>OUT</sub> is the output current.
- I<sub>Lpeak</sub> is the peak current of the inductor.
- f<sub>SW</sub> is the converter switching frequency.
- ESR is the ESR resistance of the output capacitors.

## Loop Stability

An external loop compensation network comprises resistor R5, ceramic capacitors C5 and C6 connected to the COMP pin to optimize the loop response of the converter. The power stage small signal loop response of constant off time with peak current control can be modeled by equation 11.

$$G_{PS}(S) = \frac{R_{load} \times (1 - D)}{2 \times R_{SENSE}} \times \frac{\left(1 + \frac{S}{2\pi \times f_{ESRZ}}\right) \left(1 + \frac{S}{2\pi \times f_{RHPZ}}\right)}{1 + \frac{S}{2\pi \times f_P}} \quad (11)$$

where

- D is the switching duty cycle.
- $R_{load}$  is the output load resistance.
- $R_{SENSE}$  is the equivalent internal current sense resistor, which is 0.14  $\Omega$ .

$$f_P = \frac{1}{2\pi \times R_{load} \times C_O} \quad (12)$$

where

- $C_O$  is the output capacitance

$$f_{PESRZ} = \frac{1}{2\pi \times ESR \times C_O} \quad (13)$$

where

- ESR is the equivalent series resistance of the output capacitor.

$$f_{RHPZ} = \frac{R_{load} \times (1 - D)^2}{2\pi \times L} \quad (14)$$

The COMP pin is the output of the internal trans-conductance amplifier. Equation 15 shows the small signal transfer function of compensation network.

$$G_C(S) = \frac{G_{EA} \times R_{EA} \times V_{REF}}{V_{OUT}} \times \frac{\left(1 + \frac{S}{2\pi \times f_{COMZ}}\right)}{\left(1 + \frac{S}{2\pi \times f_{COMP1}}\right) \left(1 + \frac{S}{2\pi \times f_{COMP2}}\right)} \quad (15)$$

where

- $G_{EA}$  is the amplifier's trans-conductance
- $R_{EA}$  is the amplifier's output resistance
- $V_{REF}$  is the reference voltage at the FB pin
- $V_{OUT}$  is the output voltage
- $f_{COMP1}$ ,  $f_{COMP2}$  are the poles' frequency of the compensation network.
- $f_{COMZ}$  is the zero's frequency of the compensation network.

The next step is to choose the loop crossover frequency,  $f_C$ . The higher frequency that the loop gain stays above zero before crossing over, the faster the loop response is. It is generally accepted that the loop gain cross over no higher than the lower of either 1/10 of the switching frequency,  $f_{SW}$ , or 1/5 of the RHPZ frequency,  $f_{RHPZ}$ .

Then set the value of R5, C8, and C9 in typical application circuit by following these equations.

$$R_5 = \frac{2\pi \times V_{OUT} \times R_{SENSE} \times f_C \times C_O}{(1 - D) \times V_{REF} \times G_{EA}} \quad (16)$$

where

- $f_C$  is the selected crossover frequency.

$$C_5 = \frac{R_{load} \times C_O}{2 \times R_5} \quad (17)$$

$$C_6 = \frac{ESR \times C_0}{R_5} \quad (18)$$

If the calculated value of C6 is less than 10pF, it can be left open. Designing the loop for greater than 45° of phase margin and greater than 10-dB gain margin eliminates output voltage ringing during the line and load transient.

## Application Waveforms

Vin=3.6V, Vout=9V, unless otherwise noted

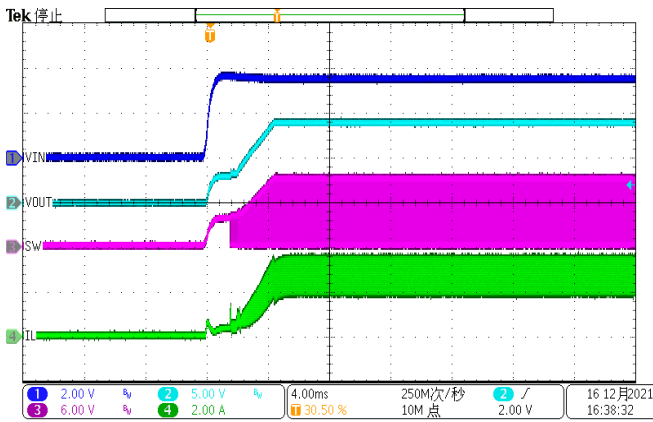

Figure 9. Power up

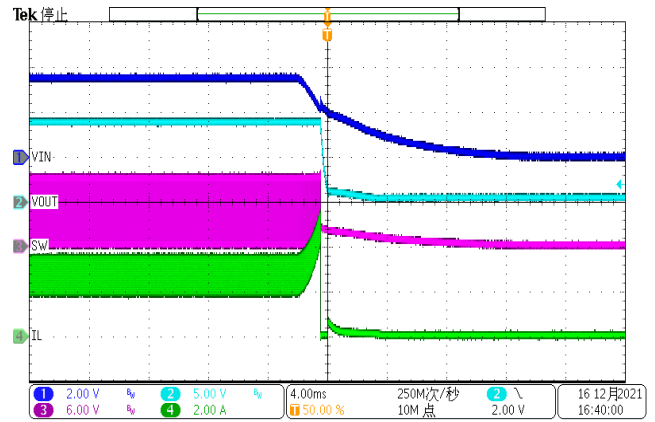

Figure 10. Power down

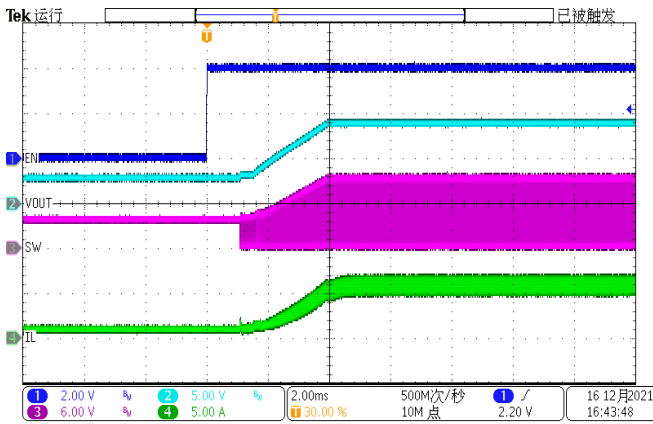

Figure 11. EN Power up (Iload=2A)

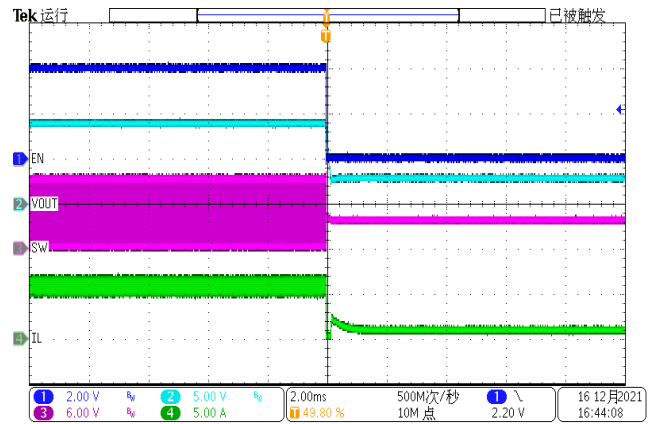

Figure 12. EN Power down(2A)

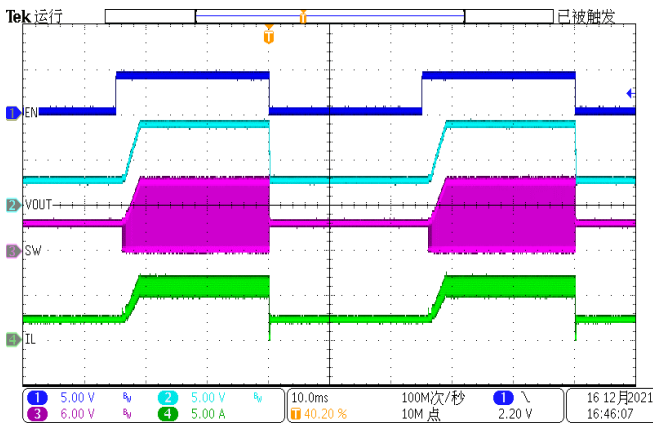

Figure 13. EN toggle (Iload=2A)

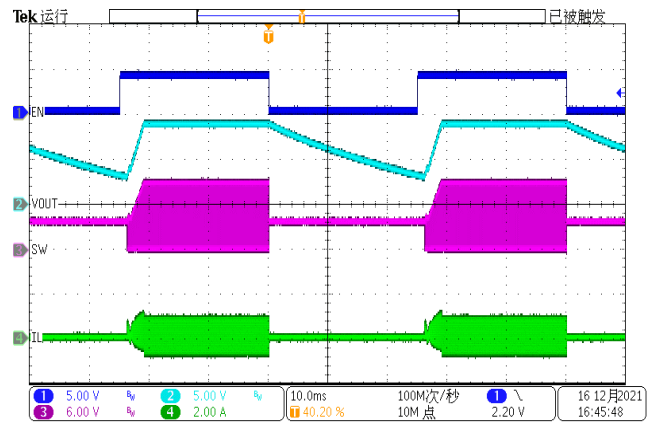

Figure 14. EN toggle (Iload=10mA)



Application Waveforms(continued)

Vin=3.6V, Vout=9V, unless otherwise noted

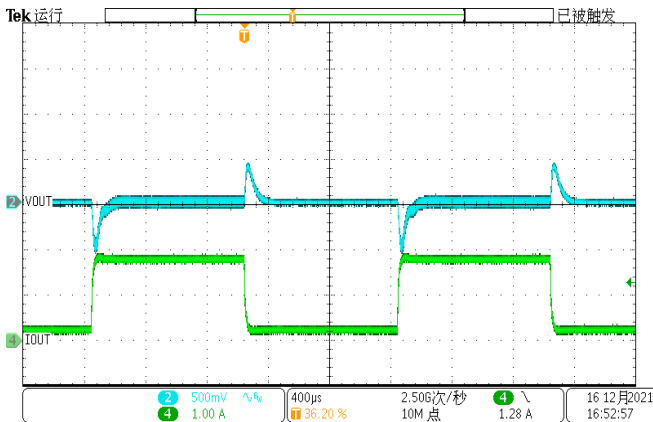

Figure 15. Load transient (0.2A-1.8A, 1.6A/us)

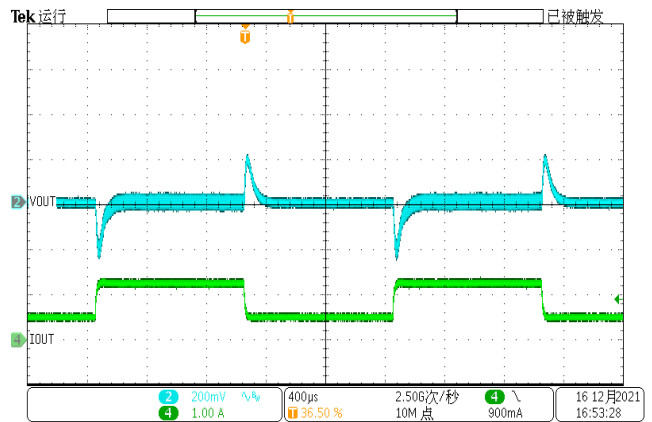

Figure 16. Load transient (0.5A-1.25A, 1.6A/us)

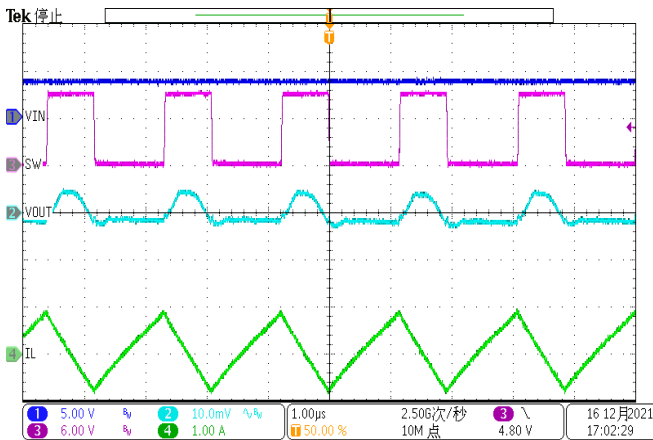

Figure 17. Steady state (Iload=0A, PFM)

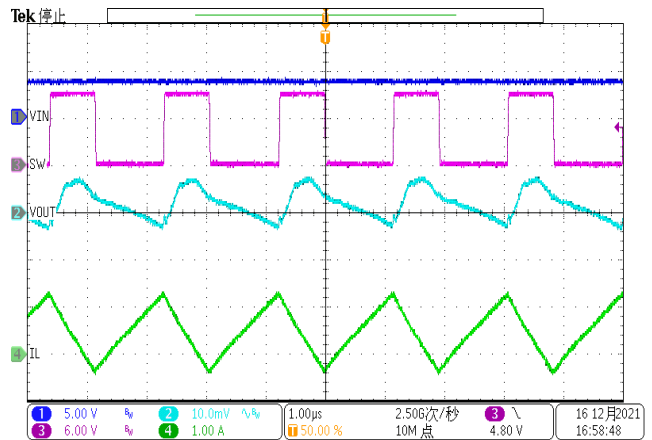

Figure 18. Steady state (Iload=150mA, PFM)

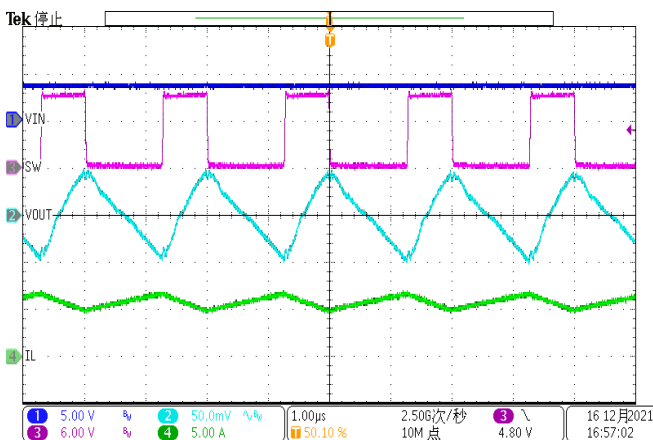

Figure 19. Steady state (Iload=2A)

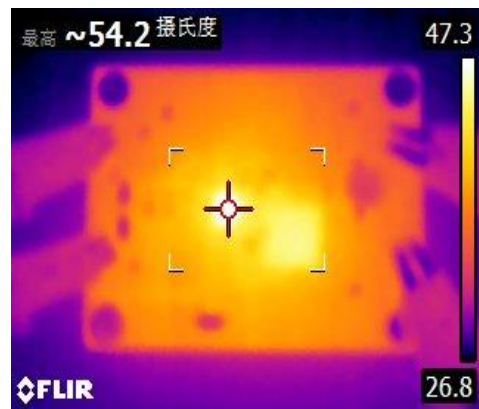

Figure 20. Thermal, Vin=3.6V, Vout=9V, Iload=2A

# SCT1270F

## Layout Guideline

The regulator could suffer from instability and noise problems without careful layout of PCB. Radiation of high-frequency noise induces EMI, so proper layout of the high-frequency switching path is essential. Minimize the length and area of all traces connected to the SW pin, and always use a ground plane under the switching regulator to minimize coupling. The input capacitor needs to be close to the VIN pin and ground pad to reduce the input supply ripple.

The most critical current path for all boost converters is from the switching FET, through the rectifier FET, then the output capacitors, and back to ground of the switching FET. This high current path contains nanosecond rise time and fall time, and should be kept as short as possible. Therefore, the output capacitor needs not only to be close to the VOUT pin, but also to the GND pin to reduce the overshoot at the SW pin and VOUT pin. The placement and ground trace for output capacitor is critical for the performance of SW ringing voltage. Place the 0.1uF output capacitor as close to VOUT pins and power ground pad as possible to reduce high frequency ringing voltage on SW pin.

The layout should also be done with well consideration of the thermal. The SW, VOUT and GND pad under the chip should always be soldered well to the board for thermal, mechanical strength and reliability. Improper soldering will cause SW higher ringing and overshoot besides downgrading thermal performance.

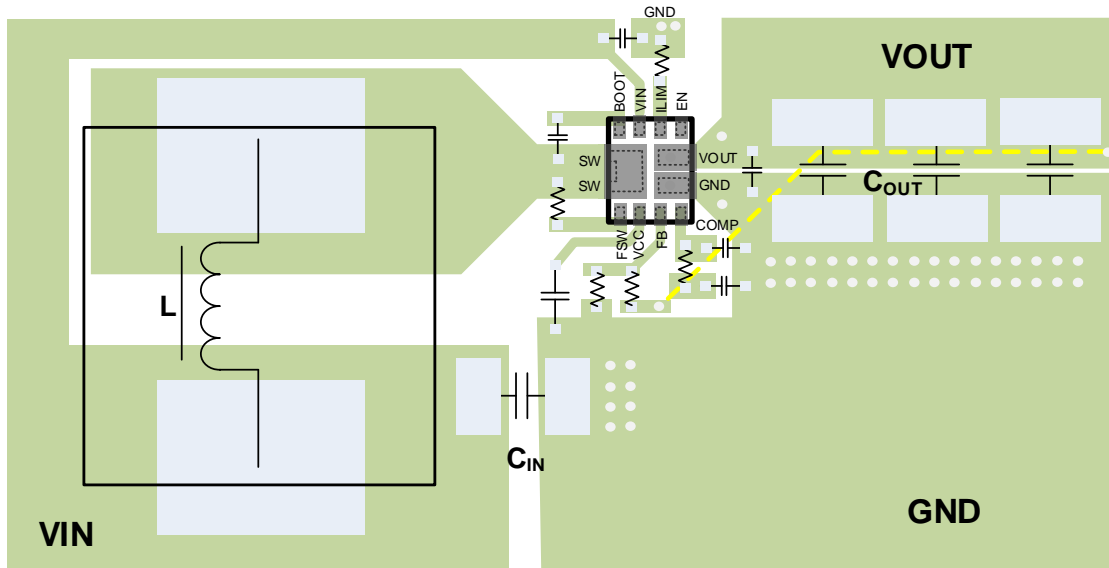

Figure 21. PCB Layout Example Top Layer

## Thermal Considerations

The maximum IC junction temperature should be restricted to 150°C under normal operating conditions. Calculate the maximum allowable dissipation,  $P_{D(max)}$ , and keep the actual power dissipation less than or equal to  $P_{D(max)}$ . The maximum-power-dissipation limit is determined using Equation 19.

$$P_{D(MAX)} = \frac{150 - T_{C_A}}{R_{\theta JA}} \quad (19)$$

where

- $T_A$  is the maximum ambient temperature for the application.
- $R_{\theta JA}$  is the junction-to-ambient thermal resistance given in the Thermal Information table.

SCT1270F QFN package includes a thermal pad that improves the thermal capabilities of the package. The real junction-to-ambient thermal resistance  $R_{\theta JA}$  of the package greatly depends on the PCB type, layout, thermal pad connection and environmental factor. Using thick PCB copper and soldering the thermal pad to a large ground plate enhance the thermal performance. Using more vias connects the ground plate on the top layer and bottom layer around the IC without solder mask also improves the thermal capability.

# SCT1270F

## PACKAGE INFORMATION

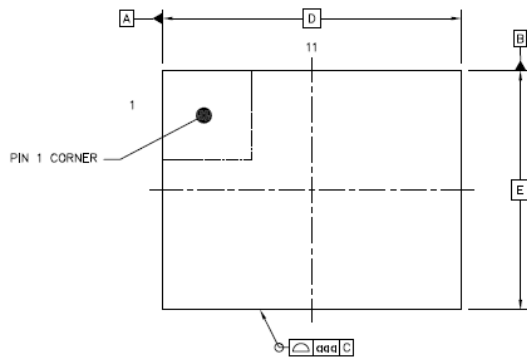

TOP VIEW

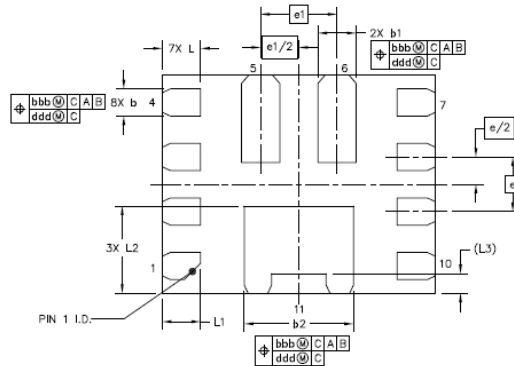

BOTTOM VIEW

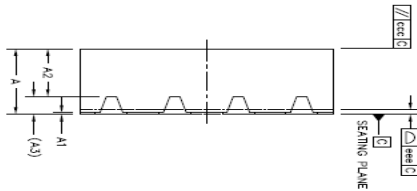

SIDE VIEW

### NOTE:

1. Drawing proposed to be made a JEDEC package outline MO-220 variation.
2. Drawing not to scale.
3. All linear dimensions are in millimeters.
4. Thermal pad shall be soldered on the board.
5. Dimensions of exposed pad on bottom of package do not include mold flash.
6. Contact PCB board fabrication for minimum solder mask web tolerances between the pins.

SYMBOL	Unit: Millimeter		
	MIN	TYP	MAX
A	0.70	0.75	0.80
A1	0	0.02	0.05
A2	---	0.55	---
A3	0.203 REF		
b	0.20	0.25	0.30
b1	0.30	0.35	0.40
b2	0.95	1	1.05
D	2.5 BSC		
E	2 BSC		
e	0.5 BSC		
e1	0.7 BSC		
L	0.3	0.35	0.4
L1	0.25	0.35	0.45
L2	0.75	0.8	0.85
L3	0.18 REF		
aaa	0.1		
ccc	0.1		
eee	0.05		
bbb	0.1		
ddd	0.05		

## TAPE AND REEL INFORMATION

Device	Package Type	Pins	SPQ
SCT1270FFQAR	QFN 2.5x2x0.75	11	3000

