

WS72551/WS72552
Zero-Drift, Single-Supply, Rail-to-Rail Input/Output Operational Amplifiers
[Http://www.willsemi.com](http://www.willsemi.com)
Descriptions

This family of amplifiers has ultra low offset, drift, and bias current. The WS72551 and WS72552 are single and dual amplifiers featuring rail-to-rail input and output swings respectively. All are guaranteed to operate from 2.5V to 5V with a single supply.

The WS72551/WS72552 provides the benefits previously found only in expensive auto-zeroing or chopper-stabilized amplifiers. These new zero-drift amplifiers combine low cost with high accuracy. No external capacitors are required.

With an offset voltage of only 3 μ V and drift of 0.008 μ V/ $^{\circ}$ C, the WS72551/WS72552 are perfectly suited for applications in which error sources cannot be tolerated. Temperature, position and pressure sensors, medical equipment, and strain gauge amplifiers benefit greatly from nearly zero drift over their operating temperature range. The rail-to-rail input and output swings provided by the WS72551/WS72552 make both high-side and low-side sensing easy.

The WS72551/WS72552 are specified for the extended industrial/automotive temperature range (-40 $^{\circ}$ C to +125 $^{\circ}$ C). The WS72551 single amplifier is available in 8-lead MSOP, 8-lead narrow SOIC and 5-lead SOT23-5L packages. The WS72552 dual amplifier is available in 8-lead MSOP and 8-lead narrow SOIC surface mount packages.

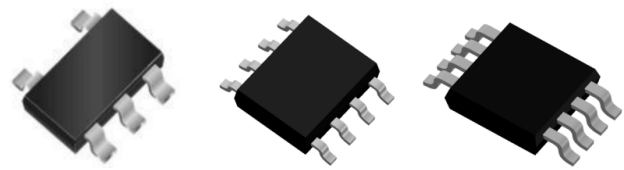
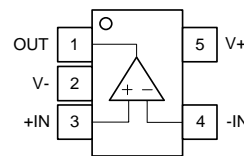
SOT23-5L
SOP-8L
MSOP-8L

SOT23-5L

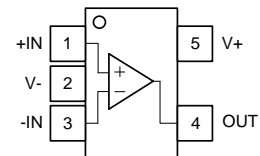
(WS72551EA-5/TR)

SOT23-5L

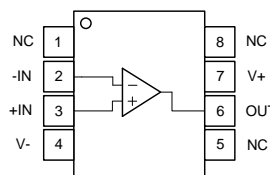
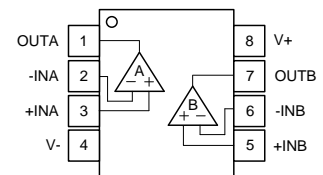
(WS72551E-5/TR)

SOP-8L/MSOP-8L

SOP-8L/MSOP-8L
Pin configuration (Top view)

SOT23-5L

SOT23-5L

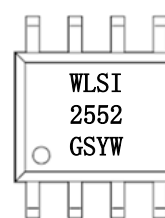
SOP-8L

MSOP-8L

SOP-8L

MSOP-8L

Applications

- Temperature sensors
- Pressure sensors
- Precision current sensing
- Strain gauge amplifiers
- Medical instrumentation
- Thermocouple amplifiers

Marking

- 2551** = Device code
- 2552** = Device code
- GA** = Special code
- GE** = Special code
- GS** = Special code
- GM** = Special code
- Y** = Year code
- W** = Week code

Features

- Low offset voltage : 14 μ V (MAX)
- Input offset drift : 0.008 μ V/ $^{\circ}$ C
- Overload recovery time : 150 μ s
- Low supply current : 240 μ A/OpAmp
- High gain, CMRR, PSRR : 130 dB
- Ultralow input bias current : 10 pA
- No external capacitors required
- 5 V/2.5 V single-supply operation
- Rail-to-rail input and output swing

Order information

Device	Package	Shipping
WS72551S-8/TR	SOP-8L	4000/Reel &Tape
WS72551M-8/TR	MSOP-8L	4000/Reel &Tape
WS72551EA-5/TR	SOT23-5L	3000/Reel &Tape
WS72551E-5/TR	SOT23-5L	3000/Reel &Tape
WS72552S-8/TR	SOP-8L	4000/Reel &Tape
WS72552M-8/TR	MSOP-8L	4000/Reel &Tape

Pin Descriptions

	Pin Number	Symbol	Descriptions
WS72551S-8/TR and WS72551M-8/TR	1	NC	
	2	-IN	Inverting input
	3	+IN	Non-inverting input
	4	V-	Negative supply
	5	NC	
	6	OUT	Output
	7	V+	Positive supply
	8	NC	

	Pin Number	Symbol	Descriptions
WS72551EA-5/TR	1	OUT	Output
	2	V-	Negative supply
	3	+IN	Non-inverting input
	4	-IN	Inverting input
	5	V+	Positive supply

	Pin Number	Symbol	Descriptions
WS72551E-5/TR	1	+IN	Non-inverting input
	2	V-	Negative supply
	3	-IN	Inverting input
	4	OUT	Output
	5	V+	Positive supply

	Pin Number	Symbol	Descriptions
WS72552S-8/TR and WS72552M-8/TR	1	OUTA	Output
	2	-INA	Inverting input
	3	+INA	Non-inverting input
	4	V-	Negative supply
	5	+INB	Non-inverting input
	6	-INB	Inverting input
	7	OUTB	Output
	8	V+	Positive supply

Absolute Maximum Ratings⁽¹⁾

Parameter	Rating	Unit
Supply Voltage ⁽²⁾	6	V
Input Voltage	GND-0.2V to Vs+0.2	V
Differential Input Voltage	±5.0	V
ESD (Human Body Model)	7000	V
Output Short-Circuit Duration to GND	Indefinite	/
Storage Temperature Range	-65 to +150	°C
Junction Temperature Range	-65 to +150	°C
Lead Temperature Range (Soldering, 60 sec)	300	°C
Operating Temperature Range	-40 to +125	°C

Note:

- Stresses beyond those listed under Absolute Maximum Ratings may cause permanent damage to the device. These are only stress ratings, and functional operation of the device at these or any other conditions beyond those indicated under recommended operating conditions are not implied. Exposure to absolute-maximum-rated conditions for extended periods may affect device reliability.
- All voltage values, except differential voltage are with respect to network terminal.

ESD, Electrostatic Discharge Protection

Symbol	Parameter	Condition	Minimum level	Unit
HBM	Human Body Model ESD	MIL-STD-883H Method 3015.8 JEDEC-EIA/JESD22-A114A	±7000	V
MM	Machine Model ESD	JEDEC-EIA/JESD22-A115	±300	V
CDM	Charged Device Model ESD	JEDEC-EIA/JESD22-C101E	±2000	V

Electronics Characteristics
 $V_S = 5\text{ V}$, $V_{CM} = 2.5\text{ V}$, $V_O = 2.5\text{ V}$, $T_A = 25^\circ\text{C}$, unless otherwise noted.

Symbol	Parameter	Conditions	Min.	Typ.	Max.	Unit
V_{OS}	Offset Voltage			5	14	μV
I_B	Input Bias Current			10		pA
		$-40^\circ\text{C} \leq T_A \leq +85^\circ\text{C}$		50		pA
		$-40^\circ\text{C} \leq T_A \leq +125^\circ\text{C}$		0.5		nA
I_{OS}	Input Offset Current			6		pA
		$-40^\circ\text{C} \leq T_A \leq +85^\circ\text{C}$		50		pA
		$-40^\circ\text{C} \leq T_A \leq +125^\circ\text{C}$		0.5		nA
VCMR	Input Voltage Range		-0.1		5.1	V
CMRR	Common Mode Rejection Ratio	$V_{CM} = -0.1\text{ V to } +5.1\text{ V}$	100	140		dB
A_{VO}	Large Signal Voltage Gain	$V_O = 0.3\text{ V to } 4.7\text{ V}$, $R_L = 10\text{ k}\Omega$	100	145		dB
		$-40^\circ\text{C} \leq T_A \leq +125^\circ\text{C}$		135		dB
$\Delta V_{OS}/\Delta T$	Offset Voltage Drift	$-40^\circ\text{C} \leq T_A \leq +125^\circ\text{C}$		0.01		$\mu\text{V}/^\circ\text{C}$
V_{OH}	Output Voltage High	$R_L = 10\text{ k}\Omega$ to GND		6	10	mV
V_{OL}	Output Voltage Low	$R_L = 100\text{ k}\Omega$ to V_+		4		mV
I_{SC}	Output Short-Circuit Limit Current		± 58	± 70		mA
PSRR	Power Supply Rejection Ratio	$V_S = 2.7\text{ V to } 5\text{ V}$	100	120		dB
I_{SY}	Supply Current / Amplifier	$V_O = 0\text{ V}$		265	340	μA
		$-40^\circ\text{C} \leq T_A \leq +125^\circ\text{C}$		290		μA
SR	Slew Rate	$R_L = 10\text{ k}\Omega$		1.2		$\text{V}/\mu\text{s}$
Tor	Overload Recovery Time			150		μs
GBP	Gain-Bandwidth Product			1.8		MHz
$e_{n\text{ p-p}}$	Voltage Noise	0.1Hz to 10Hz		1.8		μV_{P-P}
e_n	Voltage Noise Density	f=1kHz		80		$\text{nV}/\sqrt{\text{Hz}}$

Note:

1. Stresses beyond those listed under Absolute Maximum Ratings may cause permanent damage to the device. Exposure to any Absolute Maximum Rating condition for extended periods may affect device reliability and lifetime.
2. A heat sink may be required to keep the junction temperature below the absolute maximum rating when the output is shorted indefinitely.
3. Thermal resistance varies with the amount of PC board metal connected to the package. The specified values are for short traces connected to the leads.

Electronics Characteristics
 $V_S = 2.5\text{ V}$, $V_{CM} = 1.25\text{ V}$, $V_O = 1.25\text{ V}$, $T_A = 25^\circ\text{C}$, unless otherwise noted.

Symbol	Parameter	Conditions	Min.	Typ.	Max.	Unit	
V_{OS}	Offset Voltage			3	14	μV	
I_B	Input Bias Current			4		pA	
		$-40^\circ\text{C} \leq T_A \leq +85^\circ\text{C}$		40		pA	
		$-40^\circ\text{C} \leq T_A \leq +125^\circ\text{C}$		0.2		nA	
I_{OS}	Input Offset Current			4		pA	
		WS72552	$-40^\circ\text{C} \leq T_A \leq +85^\circ\text{C}$		40		pA
		WS72552	$-40^\circ\text{C} \leq T_A \leq +125^\circ\text{C}$		0.2		nA
VCMR	Input Voltage Range		-0.1		2.6	V	
CMRR	Common Mode Rejection Ratio	$V_{CM}=0\text{ V to }+2.5\text{ V}$	100	140		dB	
		$-40^\circ\text{C} \leq T_A \leq +125^\circ\text{C}$				dB	
A_{VO}	Large Signal Voltage Gain	$V_O=0.3\text{ V to }2.2\text{ V}$, $R_L=10\text{ k}\Omega$	100	140		dB	
$\Delta V_{OS}/\Delta T$	Offset Voltage Drift	$-40^\circ\text{C} \leq T_A \leq +125^\circ\text{C}$		0.008		$\mu\text{V}/^\circ\text{C}$	
V_{OH}	Output Voltage High	$R_L=10\text{ k}\Omega$ to GND		10		mV	
V_{OL}	Output Voltage Low	$R_L=10\text{ k}\Omega$ to V^+		10		mV	
I_{SC}	Output Short-Circuit Limit Current			± 20		mA	
PSRR	Power Supply Rejection Ratio	$V_S = 2.7\text{ V to }5\text{ V}$	100	120		dB	
I_{SY}	Supply Current / Amplifier	$V_O=0\text{ V}$		235	300	μA	
		$-40^\circ\text{C} \leq T_A \leq +125^\circ\text{C}$		260		μA	
SR	Slew Rate	$R_L=10\text{ k}\Omega$		1.2		$\text{V}/\mu\text{s}$	
	Overload Recovery Time			160		μs	
GBP	Gain-Bandwidth Product			1.7		MHz	
$e_{n\text{ p-p}}$	Voltage Noise	0Hz to 10Hz		1.8		μV_{P-P}	
e_n	Voltage Noise Density	$f=1\text{ kHz}$		80		$\text{nV}/\sqrt{\text{Hz}}$	

Note:

- Stresses beyond those listed under Absolute Maximum Ratings may cause permanent damage to the device. Exposure to any Absolute Maximum Rating condition for extended periods may affect device reliability and lifetime.
- A heat sink may be required to keep the junction temperature below the absolute maximum rating when the output is shorted indefinitely.
- Thermal resistance varies with the amount of PC board metal connected to the package. The specified values are for short traces connected to the leads.

Typical Characteristics

$T_A=25^\circ\text{C}$, $V_{CC}=5\text{V}$, $R_L=10\text{K}$, $C_L=100\text{pF}$, unless otherwise noted.

Small-Signal Step Response, 100mV Step

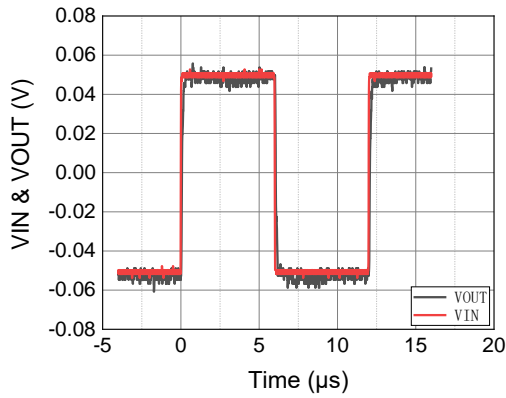

Large-Signal Step Response, 2V Step

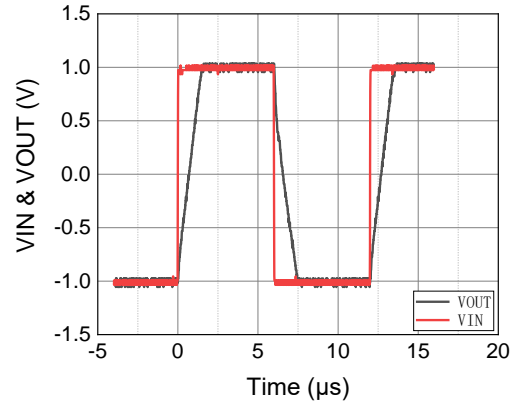

Open-Loop Gain and Phase

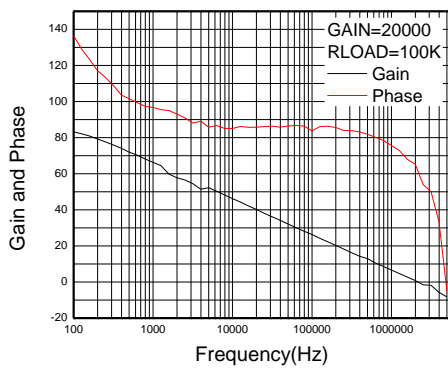

Clload vs. Phase Margin

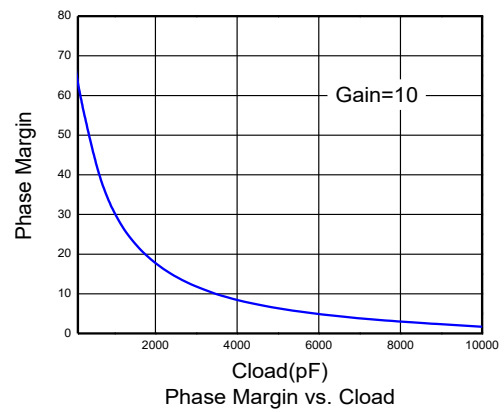

Input Offset Voltage vs. Temperature

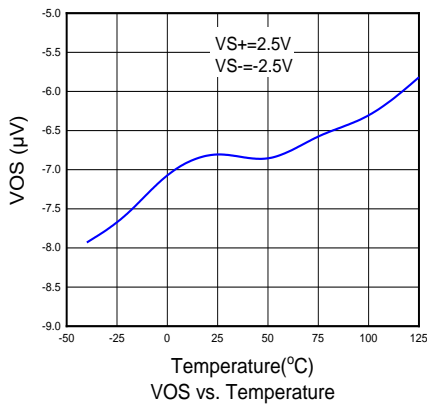

Iq vs. Supply Voltage

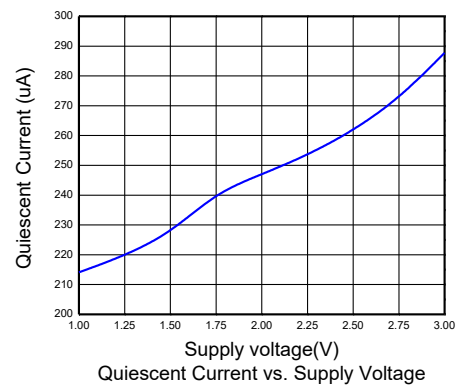

Typical Characteristics (continued)
 $T_A=25\text{ }^\circ\text{C}$, $V_{CC}=5\text{V}$, $R_L=10\text{K}$, $C_L=100\text{pF}$, unless otherwise noted.

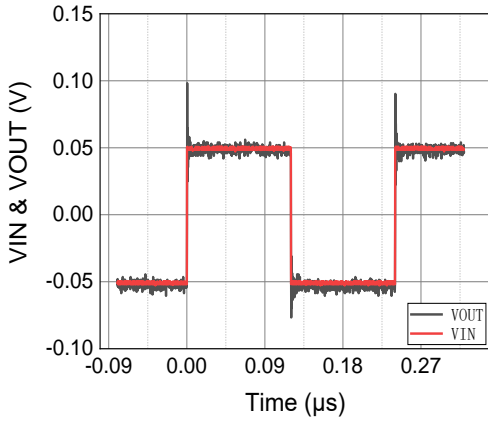
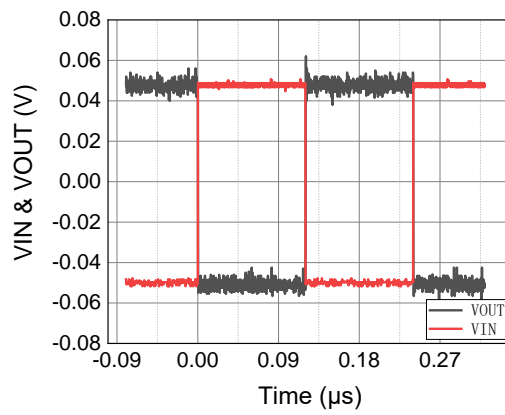
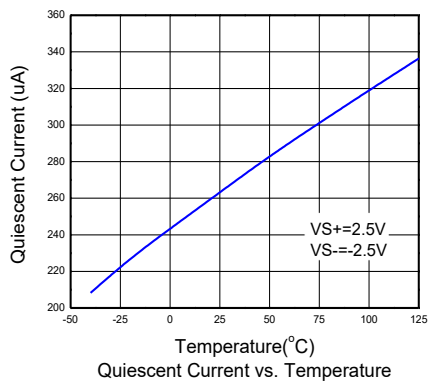
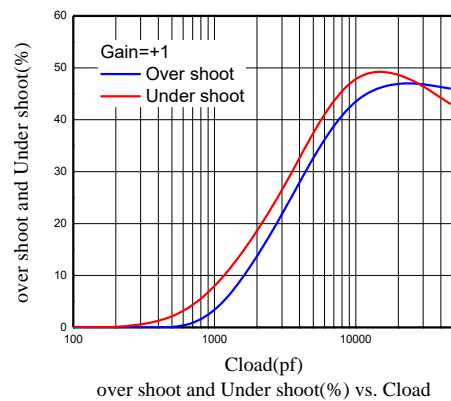
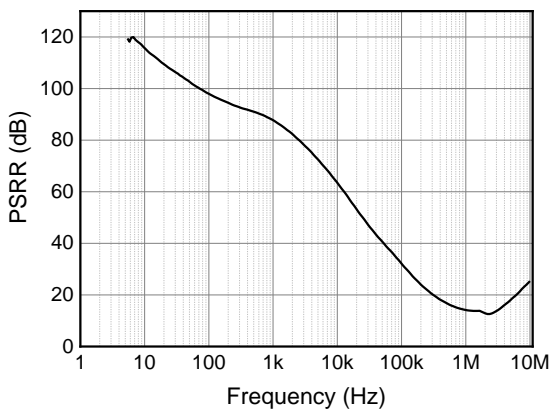
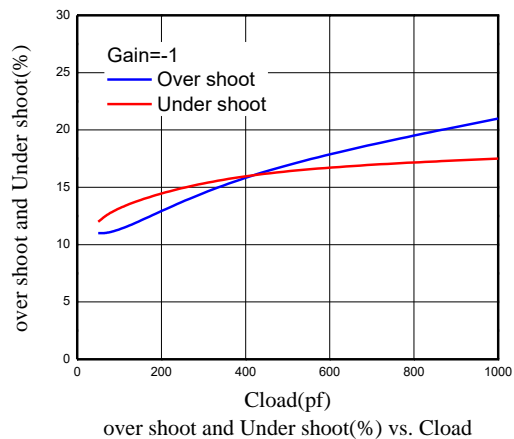
**Over Shoot Voltage, $C_{LOAD}=47\text{nF}$,
 $R_{LOAD}=10\text{k}\Omega$, Gain=+1**

**Over Shoot Voltage, $C_{LOAD}=47\text{nF}$,
 $R_F=2\text{k}\Omega$, Gain=-1**

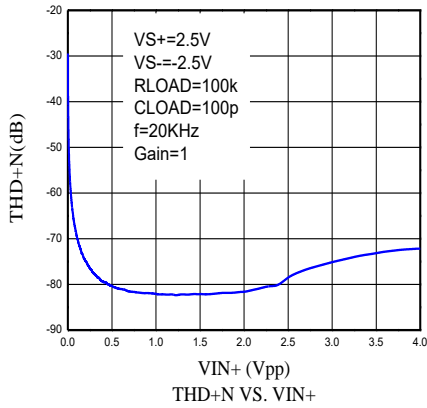
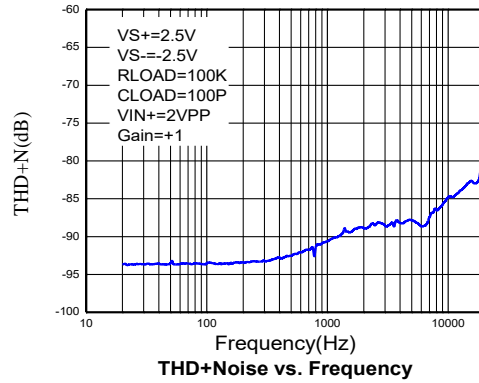
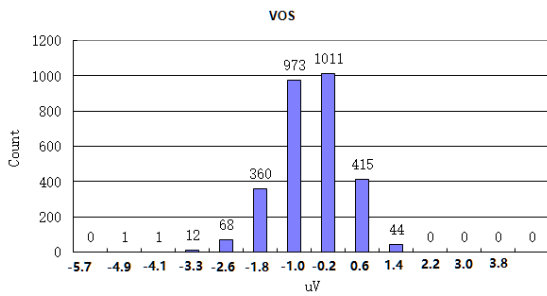
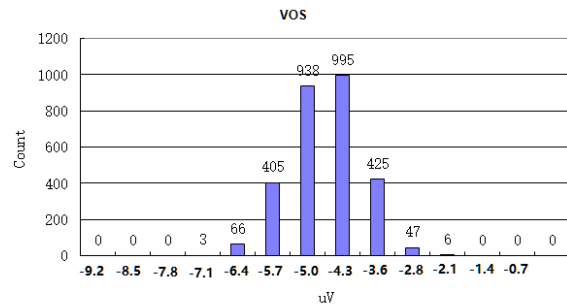
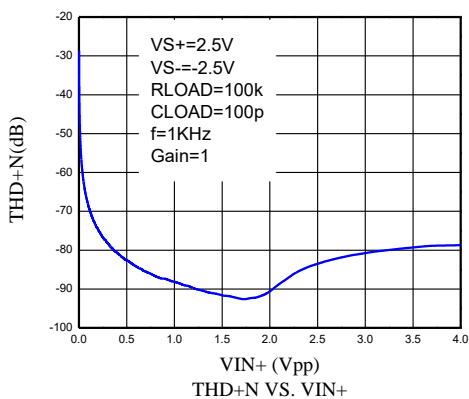
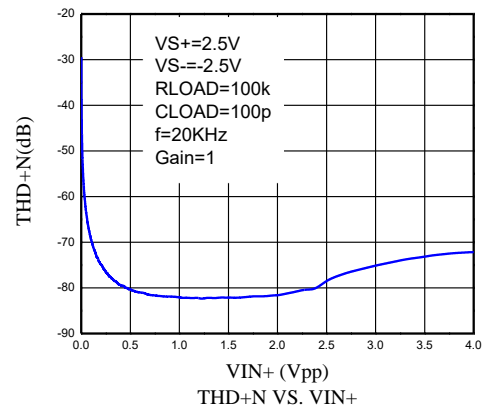
Iq vs. Temperature

Over/under shoot vs. Clload

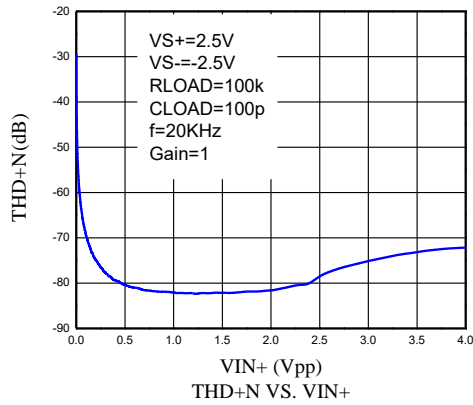
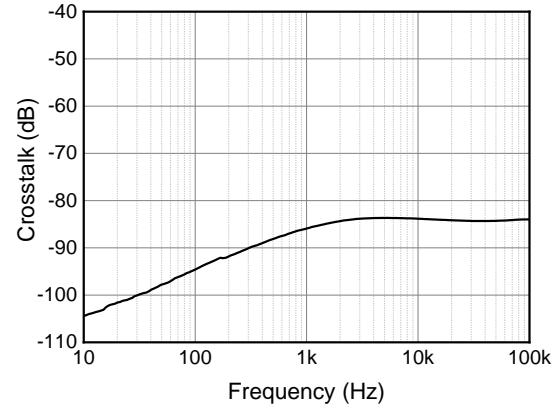
PSRR vs. Frequency

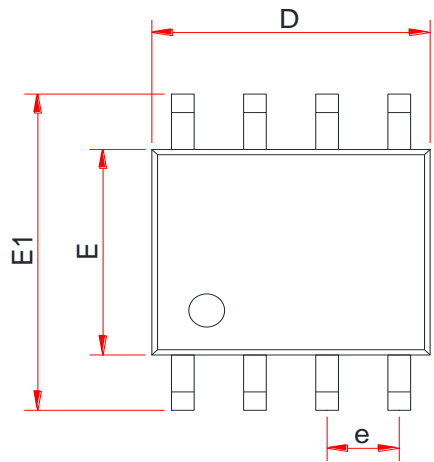
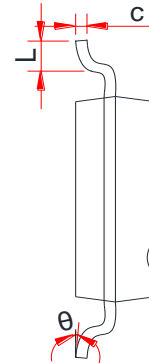
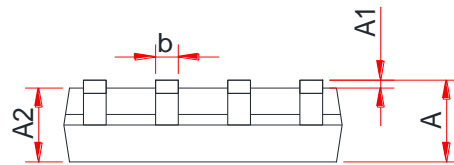
Over/under shoot vs. Clload

Typical Characteristics (continued)
 $T_A=25^\circ\text{C}$, $V_{CC}=5\text{V}$, $R_L=10\text{K}$, $C_L=100\text{pF}$, unless otherwise noted.

THD+N vs. Vin F=20KHz

THD+N vs. Frequency

Input Offset Voltage Distribution (VS+=2.5V)

Input Offset Voltage Distribution (VS+=5V)

THD+Noise vs. Vin+, Gain=+1, f=1kHz,
 $R_{LOAD}=100\text{k}\Omega$, $C_{LOAD}=100\text{pF}$

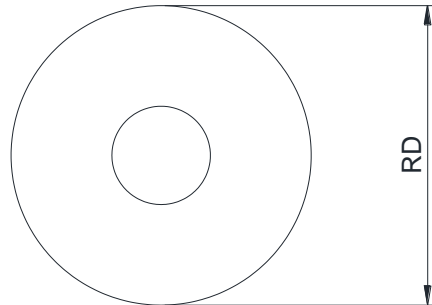
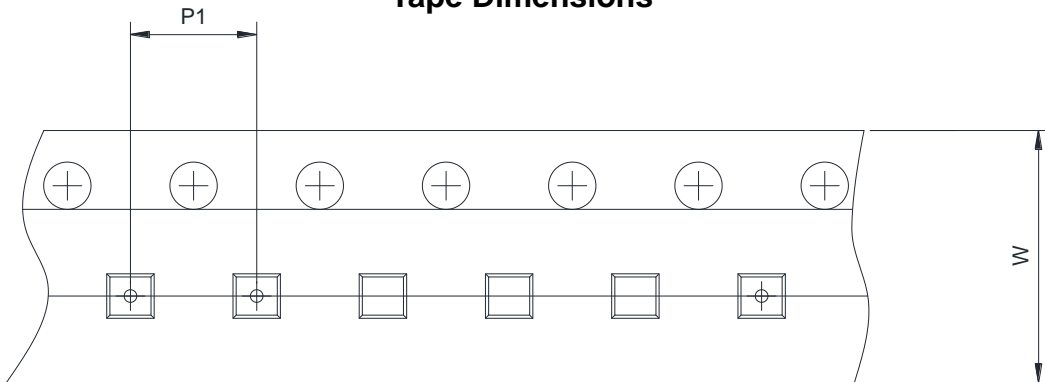
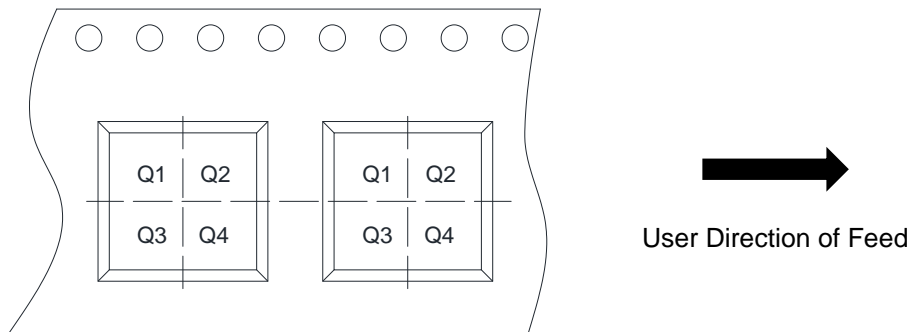
THD+Noise vs. Vin+, Gain=100, f=20kHz,
 $R_{LOAD}=100\text{k}\Omega$, $C_{LOAD}=100\text{pF}$

Typical Characteristics (continued)
 $T_A=25\text{ }^\circ\text{C}$, $V_{CC}=5\text{V}$, $R_L=10\text{K}$, $C_L=100\text{pF}$, unless otherwise noted.

THD+Noise vs. Frequency, Gain=+1,
 $V_{in+}=2V_{pp}$ $R_{LOAD}=100\text{k}\Omega$, $C_{LOAD}=100\text{pF}$

Crosstalk, (WS72552 only)

PACKAGE OUTLINE DIMENSIONS
SOP-8L

TOP VIEW

SIDE VIEW

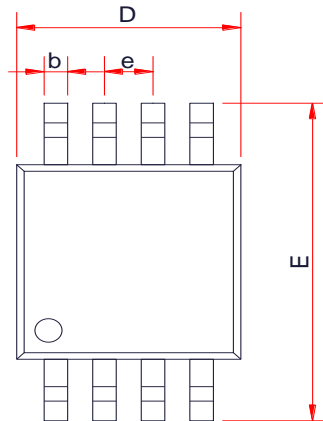
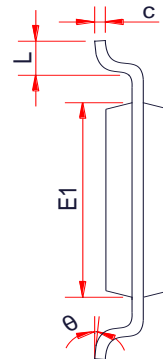
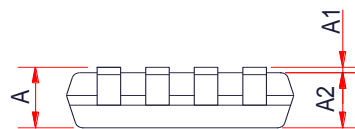
SIDE VIEW

Symbol	Dimensions In Millimeters (mm)		
	Min.	Typ.	Max.
A	1.35	1.55	1.75
A1	0.05	0.15	0.25
A2	1.25	1.40	1.65
b	0.33	-	0.51
c	0.15	-	0.26
D	4.70	4.90	5.10
E	3.70	3.90	4.10
E1	5.80	6.00	6.20
e	1.27BSC		
L	0.40	-	1.27
θ	0°	-	8°

TAPE AND REEL INFORMATION
SOP-8L
Reel Dimensions

Tape Dimensions

Quadrant Assignments For PIN1 Orientation In Tape

RD	Reel Dimension	<input type="checkbox"/> 7inch	<input checked="" type="checkbox"/> 13inch		
W	Overall width of the carrier tape	<input type="checkbox"/> 8mm	<input checked="" type="checkbox"/> 12mm		
P1	Pitch between successive cavity centers	<input type="checkbox"/> 2mm	<input type="checkbox"/> 4mm	<input checked="" type="checkbox"/> 8mm	
Pin1	Pin1 Quadrant	<input checked="" type="checkbox"/> Q1	<input type="checkbox"/> Q2	<input type="checkbox"/> Q3	<input type="checkbox"/> Q4

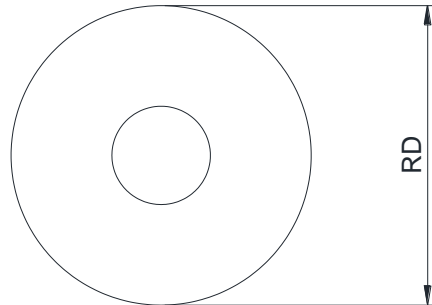
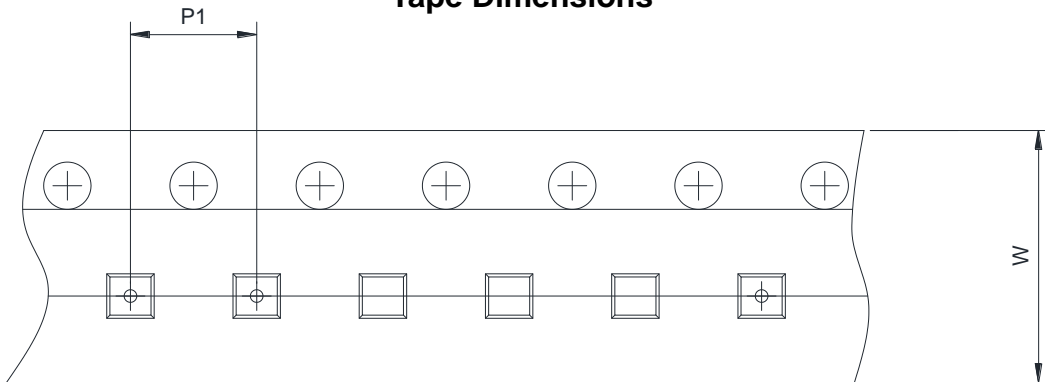
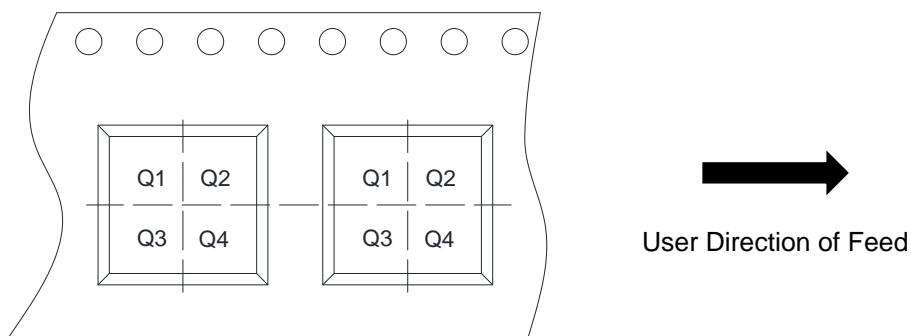
PACKAGE OUTLINE DIMENSIONS
MSOP-8L

TOP VIEW

SIDE VIEW

SIDE VIEW

Symbol	Dimensions In Millimeters (mm)		
	Min.	Typ.	Max.
A	-	-	1.10
A1	0.02	-	0.15
A2	0.75	0.80	0.95
b	0.25	-	0.38
c	0.09	-	0.23
D	2.90	3.00	3.10
E	4.75	4.90	5.05
E1	2.90	3.00	3.10
e	0.65 BSC		
L	0.40	-	0.80
θ	0°	-	6°

TAPE AND REEL INFORMATION
MSOP-8L
Reel Dimensions

Tape Dimensions

Quadrant Assignments For PIN1 Orientation In Tape

RD	Reel Dimension	<input type="checkbox"/> 7inch	<input checked="" type="checkbox"/> 13inch		
W	Overall width of the carrier tape	<input type="checkbox"/> 8mm	<input checked="" type="checkbox"/> 12mm		
P1	Pitch between successive cavity centers	<input type="checkbox"/> 2mm	<input type="checkbox"/> 4mm	<input checked="" type="checkbox"/> 8mm	
Pin1	Pin1 Quadrant	<input checked="" type="checkbox"/> Q1	<input type="checkbox"/> Q2	<input type="checkbox"/> Q3	<input type="checkbox"/> Q4

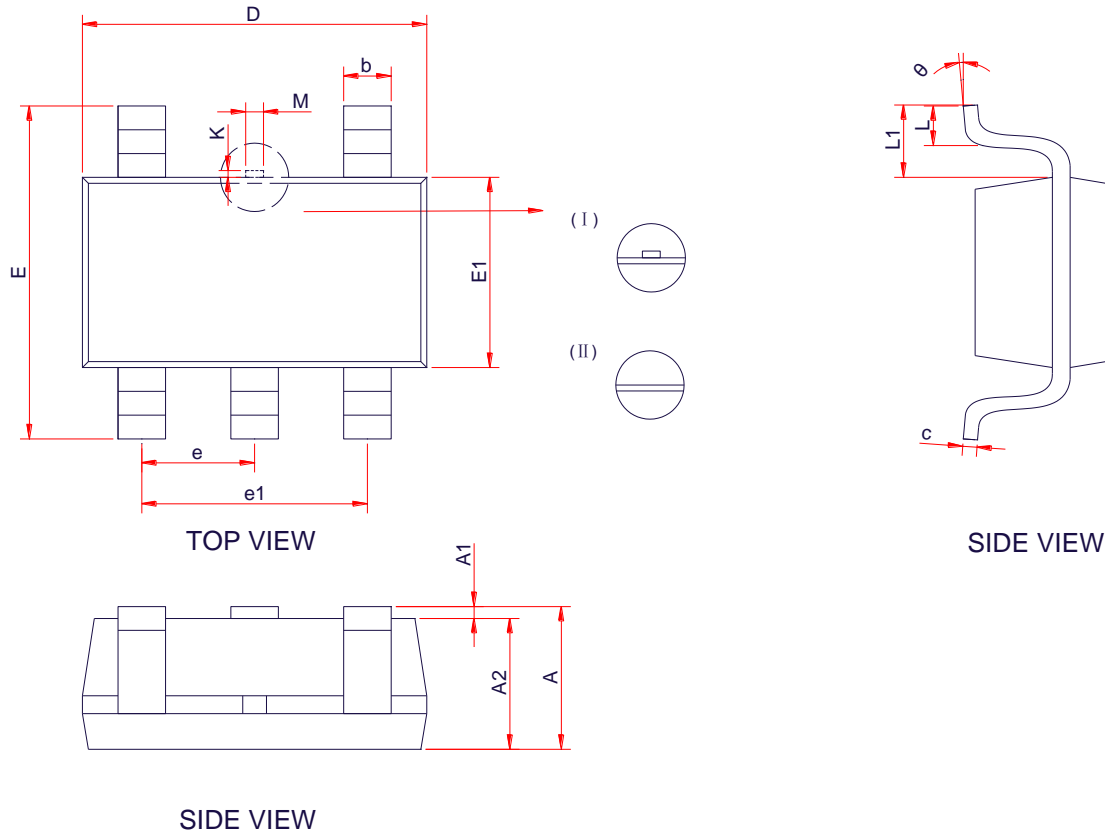
PACKAGE OUTLINE DIMENSIONS
SOT23-5L

(WS72551EA-5/TR)



Symbol	Dimensions in Millimeters		
	Min.	Typ.	Max.
A	-	-	1.45
A1	0.00	-	0.15
A2	0.90	1.10	1.30
b	0.30	0.40	0.50
c	0.10	-	0.21
D	2.72	2.92	3.12
E	2.60	2.80	3.00
E1	1.40	1.60	1.80
e	0.95 BSC		
e1	1.90 BSC		
L	0.30	0.45	0.60
M	0.10	0.15	0.25
K	0.00	-	0.25
θ	0°	-	8°

TAPE AND REEL INFORMATION
SOT23-5L
 (WS72551EA-5/TR)

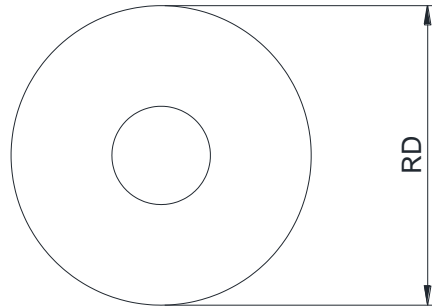
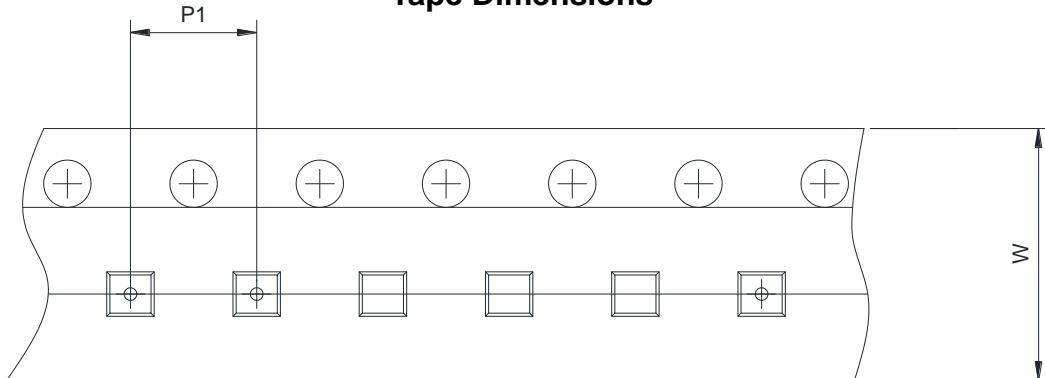
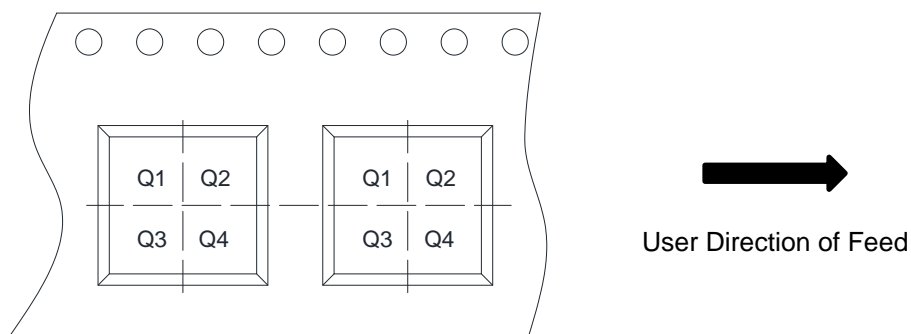
Reel Dimensions

Tape Dimensions

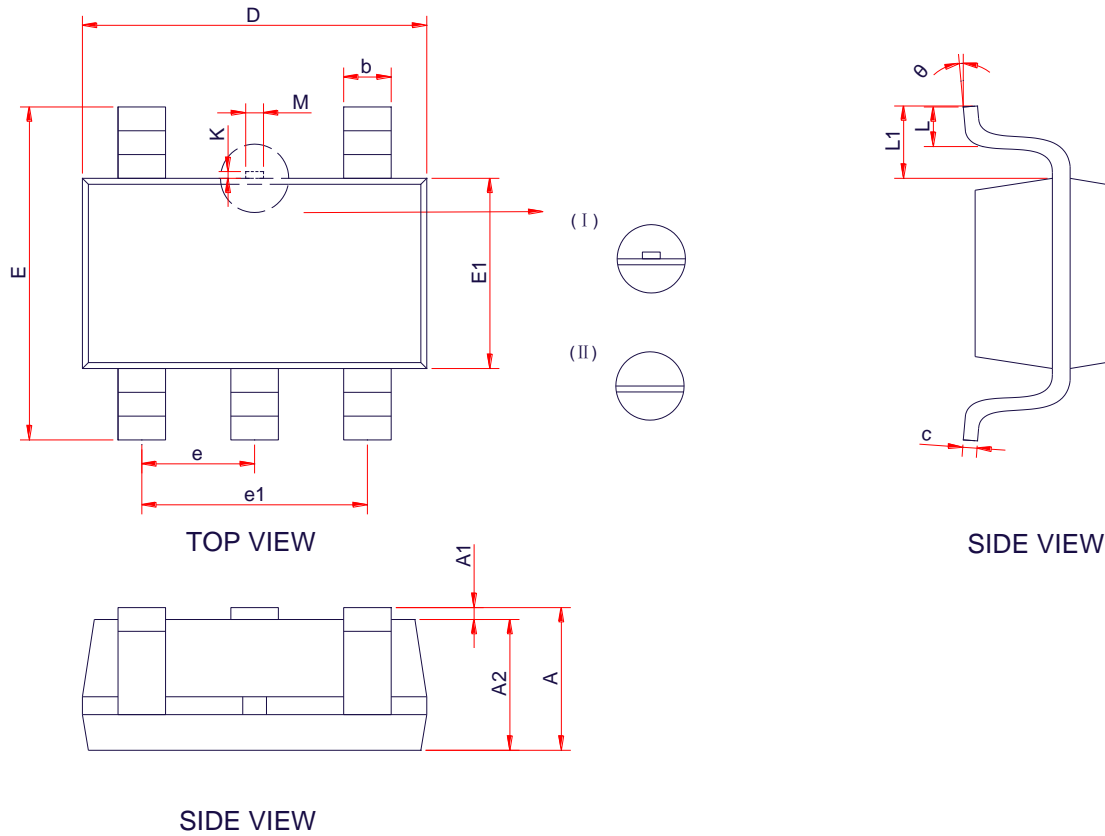
Quadrant Assignments For PIN1 Orientation In Tape

RD	Reel Dimension	<input checked="" type="checkbox"/> 7inch	<input type="checkbox"/> 13inch
W	Overall width of the carrier tape	<input checked="" type="checkbox"/> 8mm	<input type="checkbox"/> 12mm <input type="checkbox"/> 16mm
P1	Pitch between successive cavity centers	<input type="checkbox"/> 2mm	<input checked="" type="checkbox"/> 4mm <input type="checkbox"/> 8mm
Pin1	Pin1 Quadrant	<input type="checkbox"/> Q1	<input type="checkbox"/> Q2 <input checked="" type="checkbox"/> Q3 <input type="checkbox"/> Q4

PACKAGE OUTLINE DIMENSIONS
SOT23-5L
(WS72551E-5/TR)

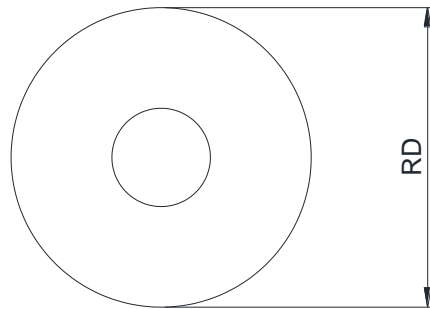
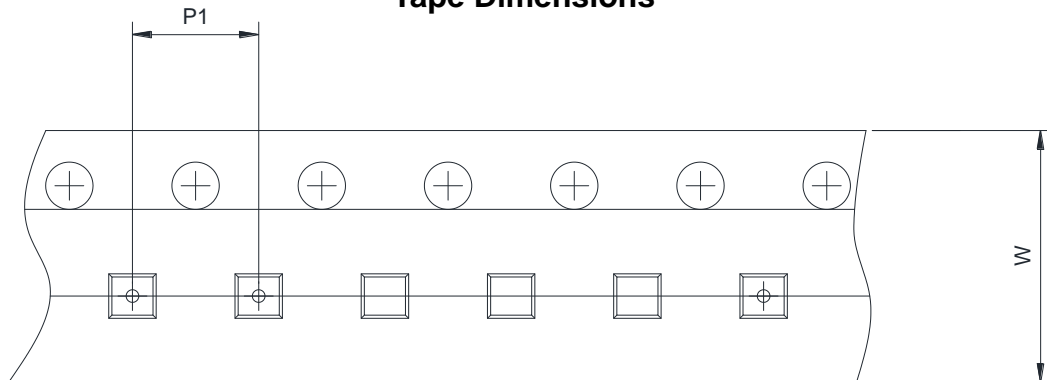
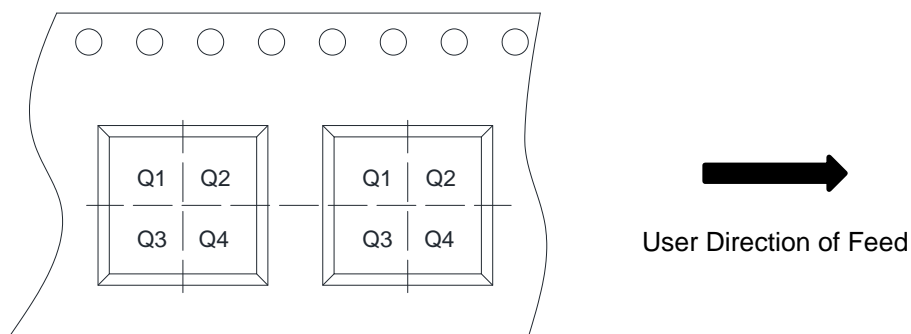
Symbol	Dimensions in Millimeters		
	Min.	Typ.	Max.
A	-	-	1.25
A1	0.00	-	0.15
A2	1.00	1.10	1.20
b	0.36	-	0.45
c	0.14	-	0.20
D	2.826	2.926	3.026
E	2.60	2.80	3.00
E1	1.526	1.626	1.726
e	0.90	0.95	1.00
e1	1.80	1.90	2.00
L	0.30	0.40	0.60
M	0.10	0.15	0.25
K	0.00	-	0.25
θ	0°	-	8°

TAPE AND REEL INFORMATION
SOT23-5L
 (WS72551E-5/TR)

Reel Dimensions

Tape Dimensions

Quadrant Assignments For PIN1 Orientation In Tape

RD	Reel Dimension	<input checked="" type="checkbox"/> 7inch	<input type="checkbox"/> 13inch
W	Overall width of the carrier tape	<input checked="" type="checkbox"/> 8mm	<input type="checkbox"/> 12mm <input type="checkbox"/> 16mm
P1	Pitch between successive cavity centers	<input type="checkbox"/> 2mm	<input checked="" type="checkbox"/> 4mm <input type="checkbox"/> 8mm
Pin1	Pin1 Quadrant	<input type="checkbox"/> Q1	<input type="checkbox"/> Q2 <input checked="" type="checkbox"/> Q3 <input type="checkbox"/> Q4