

SPECIFICATION

SPEC NO. TFA9NAA00580

DATE : Oct.23rd, 2017

To

XIAMEN XIANGGAO ELECTRONICS CO.,LTD

CUSTOMER'S PRODUCT NAME

DPX255850DT-5145F1

TDK'S PRODUCT NAME

DPX255850DT-5145F1

RECEIPT CONFIRMATION

DATE : YEAR MONTH DAY

TDK Corporation

Sales

Electronic Components Sales &
Marketing Group

Engineering

Electronic Components Business Company
Communication Devices Business Group

APPROVED	PERSON IN CHARGE

APPROVED	CHECKED	PERSON IN CHARGE
<i>N. Harada</i>	<i>A. Okada</i>	<i>H. Ashida</i>

Diplexer Specification
 (TDK Part Number : DPX255850DT-5145F1)

1. Marking

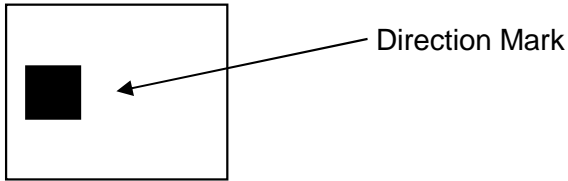

2. Mechanical Outline

2-1 Package

Package:	Surface mount package
Delivery Medium:	Tape on reel
Soldering Method:	IR-reflow
Size:	2.50 x 2.00mm typ.
Height:	0.65 mm max.

MECHANICAL DIMENSIONS

[Top View]

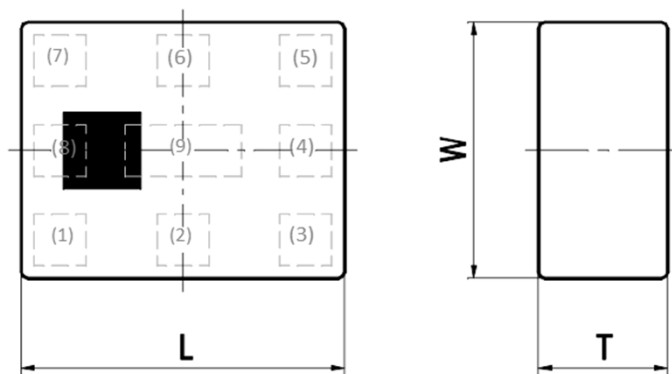

[Bottom View]

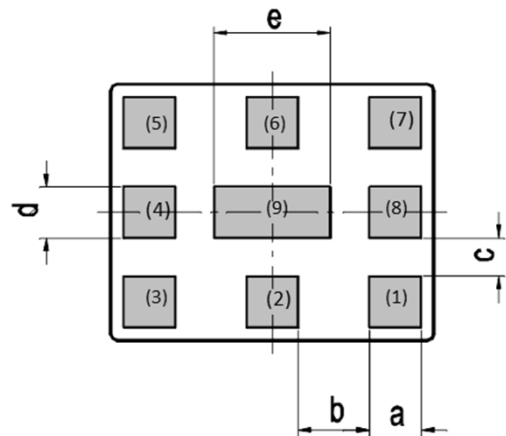

Dimensions (mm)

L	W	T	a	b	c	d	e
2.50	2.00	0.65	0.40	0.55	0.30	0.40	0.90
+/-0.15	+/-0.15	Max	+/-0.10	+/-0.10	+/-0.10	+/-0.10	+/-0.15

Terminal functions

(1)	GND
(2)	Common Port
(3)	GND
(4)	GND
(5)	Low-Band Port

(6)	GND
(7)	High-Band Port
(8)	GND
(9)	GND

2-2 Coplanarity

0.05 mm max. difference in Z-direction as follows

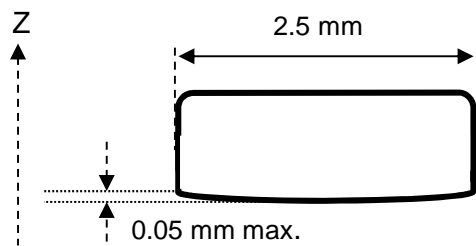

Coplanarity measurement method

Coplanarity = T1-T2

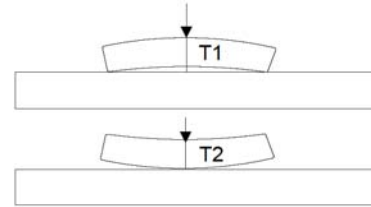

Each terminal extends the full of the product. Hence any coplanarity deviation between terminals is due to curvature in the substrate. TDK guarantees that the edge of each terminal is within 0.05 mm of the horizontal plane.

3. Environment (Temperature & Humidity)

3-1 Operating & Storage condition

Storage temperature range : -40 ~ +85 °C

Operating temperature range : -40 ~ +85 °C

Humidity : 0 ~ 90 % R.H. (Max. wet bulb temperature 38 °C)

3-2 Storage condition before soldering

Temperature : +5 ~ +30 °C

Humidity : 20 ~ 70 % RH

Term of storage : Within 12 months before opening

Within 1 month after opening

Baking : Unnecessary

3-3 Moisture sensitivity level

Equal to Level 1

4. Electrical Specification

Low-Band

Parameter	Frequency (MHz)	TDK Spec		
		Min.	Typ.	Max.
Insertion Loss (dB)	698 to 960	-	0.08	0.40
	1427 to 1511	-	0.15	0.45
	1710 to 2170	-	0.23	0.45
	2300 to 2496	-	0.32	0.60
	2496 to 2690	-	0.48	0.65
Insertion Loss (dB) (-40 to +85 °C)	698 to 960	-	-	0.45
	1427 to 1511	-	-	0.50
	1710 to 2170	-	-	0.50
	2300 to 2496	-	-	0.65
	2496 to 2690	-	-	0.75
VSWR	698 to 960	-	1.17	1.50
	1427 to 2690	-	1.25	1.65
Attenuation (dB)	3400 to 3800	23	28	-
	5150 to 5850	28	29	-

Ta = +25+/-5°C

High-Band

Parameter	Frequency (MHz)	TDK Spec		
		Min.	Typ.	Max.
Insertion Loss (dB)	3400 to 3600	-	0.62	0.80
	3600 to 3800	-	0.46	0.70
	5150 to 5850	-	0.40	0.60
Insertion Loss (dB) (-40 to +85 °C)	3400 to 3600	-	-	0.90
	3600 to 3800	-	-	0.80
	5150 to 5850	-	-	0.70
VSWR	3400 to 3800	-	1.25	1.70
	5150 to 5850	-	1.43	2.00
Attenuation (dB)	698 to 960	30	33	-
	1427 to 1511	27	32	-
	1710 to 2690	23	27	-
	10300 to 11700	15	31	-
	15450 to 17550	5	10	-

Ta = +25+/-5°C

Common

Parameter	Frequency (MHz)	TDK Spec		
		Min.	Typ.	Max.
VSWR	698 to 960	-	1.15	1.50
	1427 to 2690	-	1.24	1.65
	3400 to 3800	-	1.36	1.70
	5150 to 5850	-	1.40	2.00
Power Handling (W)		-	-	1
Characteristic Impedance (ohm)		50 (Nominal)		

Ta = +25+/-5°C

Low - High

Parameter	Frequency (MHz)	TDK Spec		
		Min.	Typ.	Max.
Isolation (dB)	698 to 960	30	33	-
	1427 to 1511	27	32	-
	1710 to 2690	23	27	-
	3400 to 3800	23	29	-
	5150 to 5850	28	31	-

Ta = +25+/-5°C

5. Typical electrical characteristics

Low-Band Port Insertion Loss S21

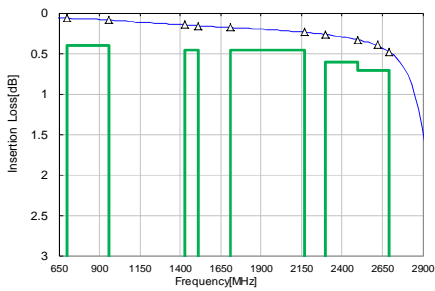

698 MHz	0.06 dB
960 MHz	0.08 dB
1427 MHz	0.14 dB
1511 MHz	0.15 dB
1710 MHz	0.17 dB
2170 MHz	0.23 dB
2300 MHz	0.26 dB
2496 MHz	0.32 dB
2620 MHz	0.39 dB
2690 MHz	0.48 dB

High-Band Port Insertion Loss S31

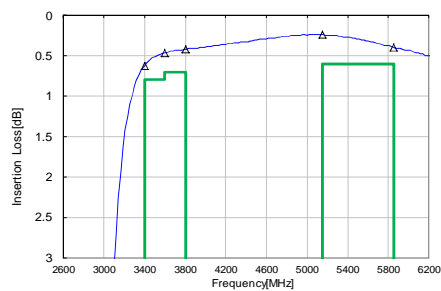

3400 MHz	0.62 dB
3600 MHz	0.46 dB
3800 MHz	0.42 dB
5150 MHz	0.24 dB
5850 MHz	0.40 dB

Low-Band Port Attenuation S21

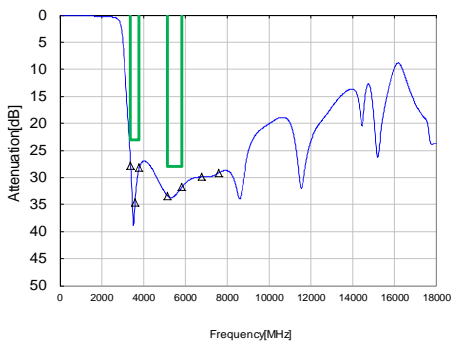

3400 MHz	27.9 dB
3600 MHz	34.6 dB
3800 MHz	28.2 dB
5150 MHz	33.4 dB
5850 MHz	31.8 dB
6800 MHz	29.9 dB
7600 MHz	29.2 dB

High-Band Port Attenuation S31

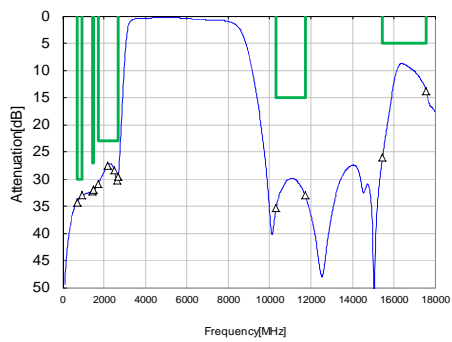

698 MHz	34.3 dB
960 MHz	33.0 dB
1427 MHz	32.2 dB
1511 MHz	32.0 dB
1710 MHz	31.0 dB
2170 MHz	27.6 dB
2496 MHz	28.4 dB
2620 MHz	30.2 dB
2690 MHz	29.6 dB
10300 MHz	35.3 dB
11700 MHz	33.0 dB
15450 MHz	26.0 dB
17550 MHz	13.8 dB

Low-Band Port VSWR S22

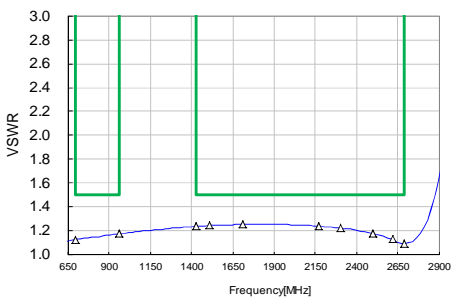

698 MHz	1.12 dB
960 MHz	1.17 dB
1427 MHz	1.24 dB
1511 MHz	1.24 dB
1710 MHz	1.25 dB
2170 MHz	1.24 dB
2300 MHz	1.22 dB
2496 MHz	1.18 dB
2620 MHz	1.13 dB
2690 MHz	1.09 dB

High-Band Port VSWR S33

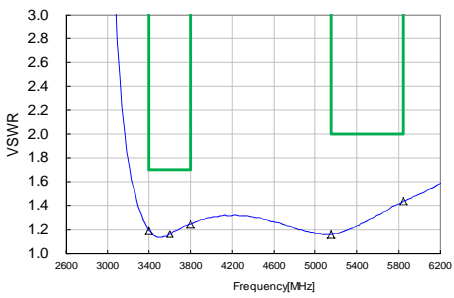

3400 MHz	1.19 dB
3600 MHz	1.16 dB
3800 MHz	1.25 dB
5150 MHz	1.16 dB
5850 MHz	1.43 dB

Common Port VSWR S11

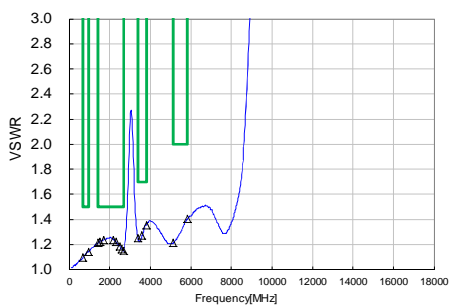

698 MHz	1.10 dB
960 MHz	1.15 dB
1427 MHz	1.21 dB
1511 MHz	1.22 dB
1710 MHz	1.24 dB
2170 MHz	1.24 dB
2300 MHz	1.22 dB
2496 MHz	1.19 dB
2620 MHz	1.16 dB
2690 MHz	1.15 dB
3400 MHz	1.25 dB
3600 MHz	1.27 dB
3800 MHz	1.36 dB
5150 MHz	1.21 dB
5850 MHz	1.40 dB

Isolation (Low - High) S23

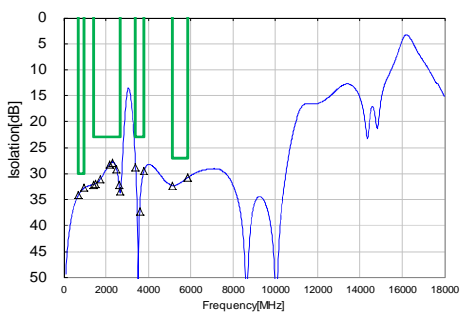

698 MHz	34.1 dB
960 MHz	32.8 dB
1427 MHz	32.1 dB
1511 MHz	31.9 dB
1710 MHz	31.2 dB
2170 MHz	28.2 dB
2300 MHz	27.8 dB
2496 MHz	29.1 dB
2620 MHz	32.2 dB
2690 MHz	33.3 dB
3400 MHz	28.8 dB
3600 MHz	37.4 dB
3800 MHz	29.6 dB
5150 MHz	32.3 dB
5850 MHz	30.8 dB

7. Evaluation PCB and Land Pattern

Land Pattern

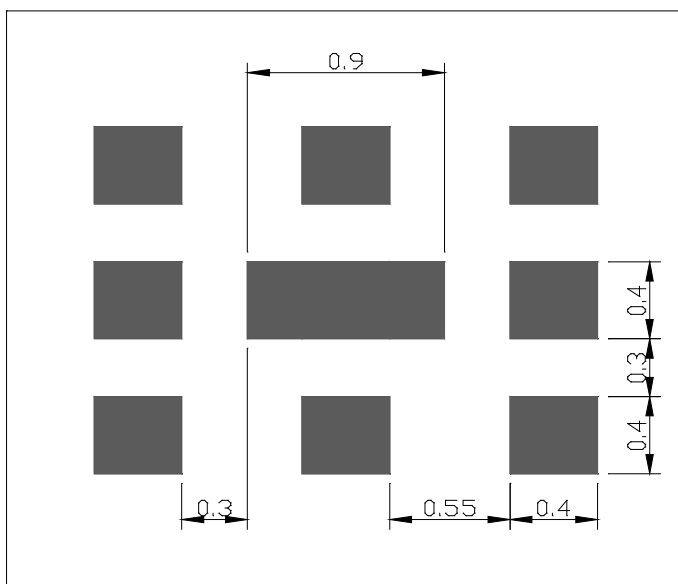

(Unit:mm)

Evaluation Board

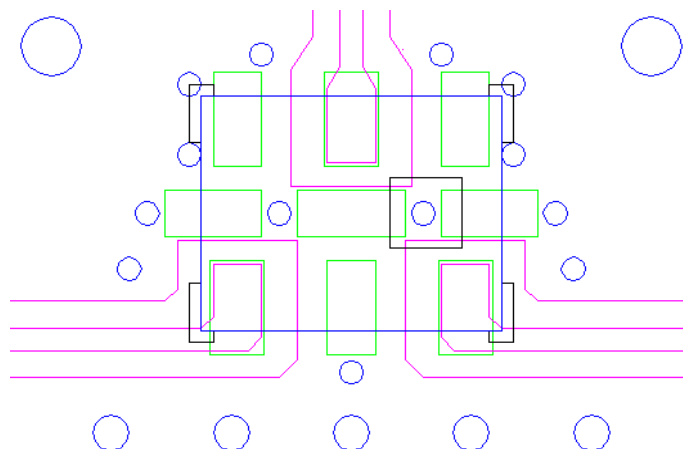

Material, Layer	Thickness
Top Resist	Resist
Copper Surface Pattern	0.035mm
FR-4	0.10mm
Copper Inner GND	0.018mm
FR-4	0.30mm
Copper Bottom GND	0.035mm

8. Environmental and quality proposal

This product satisfies the electrical specification after the following tests.
 (When measured after two hours in normal conditions)

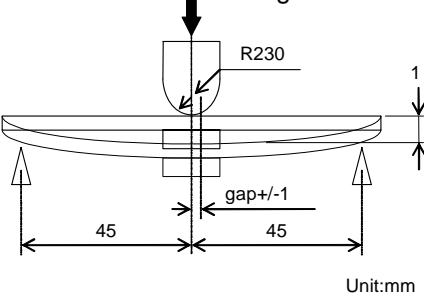
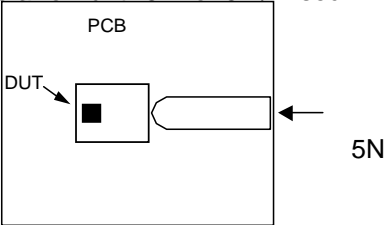
Temperature characteristics:	All data initially taken at +25°C, then repeated at -40°C and again at +85°C.
Heat proof:	+85 °C+/-2 °C for 1000 hours
Cold proof:	-40 °C +/-2 °C or 500 hours
Moisture proof:	+60 °C +/-2 °C, 90~95% R.H. for 1000 hours
Heat shock:	-40 ~ +85 °C for 350 cycles each cycle being 30 min
Vibration:	10-500Hz vibration frequency (10G Max.) with 1.52mmp-p amplitude for two hours in x,y,z directions
Mechanical shock:	1.Acceleration 1000m/s2 2.Direction X, Y, Z ,X',Y',Z',axes 3.Time 6ms duration and 3 times in each direction
Solderability	The dipped surface of the terminal shall be at least 75% covered with solder after dipped in solder bath of 245 °C+/-3 °C for 3+/-0.5 sec. Remark solder: Sn-3.0Ag-0.5Cu Remark flux: Rosin 25%, Alcohol 75%
Solder heat shock	It shall be possible to hot air reflow the components three times with a temperature profile shown below.
Drop shock:	Dropped onto steel plate or concrete from 100cm height three times.
Bending test:	Solder specimen components on the test printed circuit board(L:100 x w:40 x t:0.8mm) in appended recommended PCB pattern Apply the load in direction of the arrow until bending reaches 1mm for 5+/-1 sec. 
Board adhesion (Push test):	Solder specimen components on the test printed circuit board(L:100 x w:40 x t:0.8mm) in appended recommended PCB pattern Apply the load in direction of the arrow until 5N for 5 +/-1 sec . 

9. Recommended reflowing temperature profile

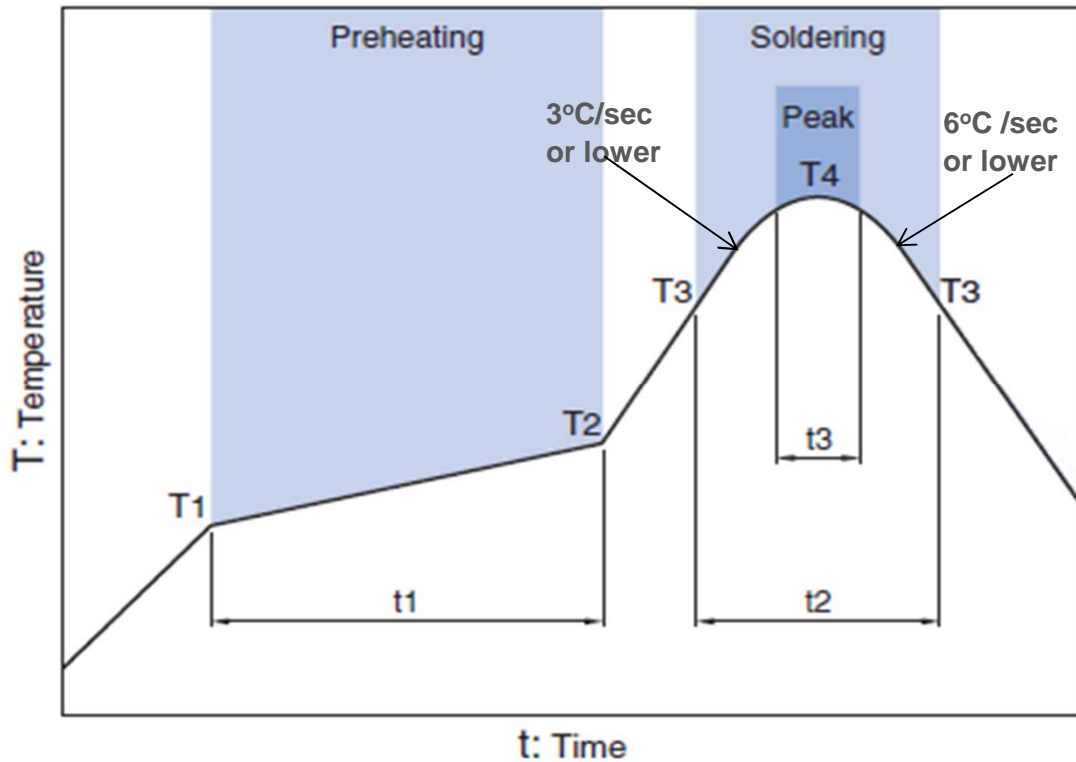

Preheating			Soldering			
			Critical zone (T3 to T4)		Peak	
Temp.		Time	Temp.	Time	Temp.	Time
T1	T2	t1	T3	t2	T4	t3 *
150°C	200°C	60 to 120sec	217°C	60 to 120sec	240 to 260°C	30 sec Max

* t3 : Time within 5°C of actual peak temperature.

The maximum number of reflow is 3.

Note: Lead free solder is recommended.
Recommended solder is Sn-3.0Ag-0.5Cu. (M705 by Senju Metal Industry)

10. Packing

10-1 Carrier tape

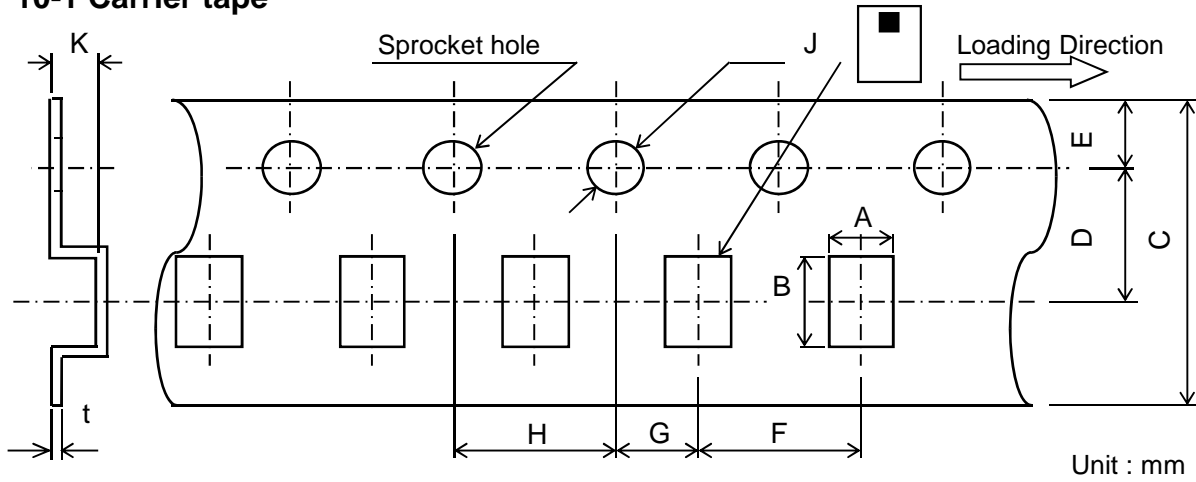

A	B	C	D	E	F	G	H	J	K	t
2.2	2.7	8.0	3.5	1.75	4.0	2.0	4.0	1.5	0.85	0.25
+/-0.05	+/-0.05	+0.3/-0.1	+/-0.05	+/-0.1	+/-0.1	+/-0.05	+/-0.1	+0.1/-0	Max	+/-0.05

10-2. Reel Dimensions

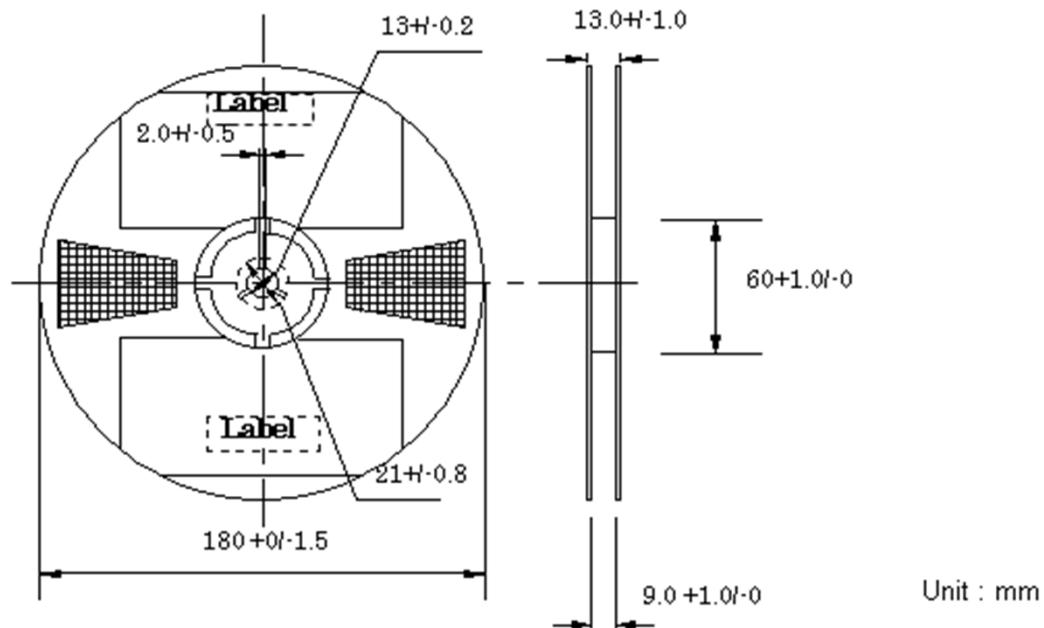

10-3. Standard Reel Packaging quantities

2000pcs./reel

11. Other

11-1 Notice

The products listed on this specification sheet are intended for use in general electronic equipment (AV equipment, telecommunications equipment, home appliances, amusement equipment, computer equipment, personal equipment, office equipment, measurement equipment, industrial robots) under a normal operation and use condition.

The products are not designed or warranted to meet the requirements of the applications listed below, whose performance and/or quality require a more stringent level of safety or reliability, or whose failure, malfunction or trouble could cause serious damage to society, person or property. Please understand that we are not responsible for any damage or liability caused by use of the products in any of the applications below or for any other use exceeding the range or conditions set forth in this specification sheet.

Aerospace/Aviation equipment
Transportation equipment (cars, electric trains, ships, etc.)
Medical equipment
Power-generation control equipment
Atomic energy-related equipment
Seabed equipment
Transportation control equipment
Public information-processing equipment
Military equipment
Electric heating apparatus, burning equipment
Disaster prevention/crime prevention equipment
Safety equipment
Other applications that are not considered general-purpose applications

When designing your equipment even for general-purpose applications, you are kindly requested to take into consideration securing protection circuit/device or providing backup circuits in your equipment.

11-2 Product Origin

1. TDK Akita Corporation, Akita, Japan
2. TDK Dalian Corporation, Dalian ,China