

ESD5V0AP

Description

ESD5V0AP is designed to protect voltage sensitive components from ESD and transient voltage events. Excellent clamping capability, low leakage, and fast response time, make these parts ideal for ESD protection on designs where board space is at a premium.

Features

- Ultra low leakage
- Operating voltage: 5V
- Package: SOT-23
- Protects one bidirectional line or two unidirectional
- Low clamping voltage
- Complies with following standards:
 - IEC 61000-4-2 (ESD) immunity test
 - Air discharge: $\pm 15\text{kV}$
 - Contact discharge: $\pm 8\text{kV}$
 - IEC61000-4-4 (EFT) 40A (5/50ns)
 - IEC61000-4-5 (Lightning) 5A (8/20 μs)

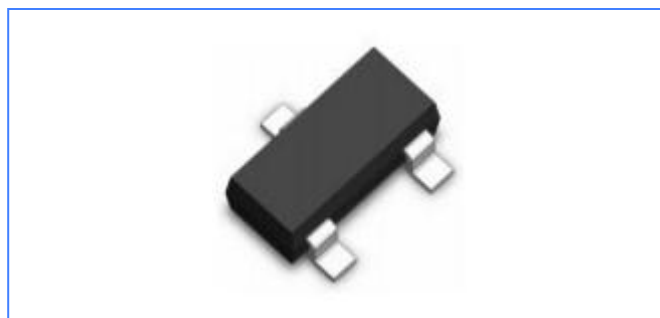

Functional Diagram

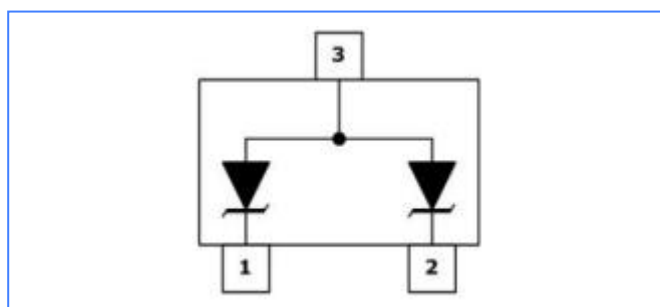

Applications

- Portable Electronics
- Cellular Handsets and Accessories
- Industrial Controls
- Portable instrumentation
- Set-Top Box
- Peripherals

Absolute Maximum Ratings(Tamb=25°C unless otherwise specified)

Parameter	Symbol	Value	Unit
Peak Pulse Power (8/20 μs)	P_{PP}	300	Watts
ESD per IEC 61000-4-2 (Air)	V_{ESD}	± 15	KV
ESD per IEC 61000-4-2 (Contact)		± 8	KV
Lead Soldering Temperature	TL	260 (10 sec)	°C
Operating Temperature Range	T_J	-55 to +150	°C
Storage Temperature Range	T_{STJ}	-55 to +150	°C

Electrical Characteristics (TA = 25 °C unless otherwise noted)

Parameter	Symbol	Conditions	Min.	Typ.	Max.	Units
Reverse Stand-off Voltage	V_{RWM}				5	V
Reverse Breakdown Voltage	V_{BR}	$I_i = 1mA$	6.2		7.3	V
Reverse Leakage Current	I_R	$V_R = V_{RWM}$			10	μA
Clamping Voltage	V_C	@IPP			9.8	V
Junction Capacitance	C_J	$V_R=0V, f = 1MHz$		110		pF

Characteristics Curves

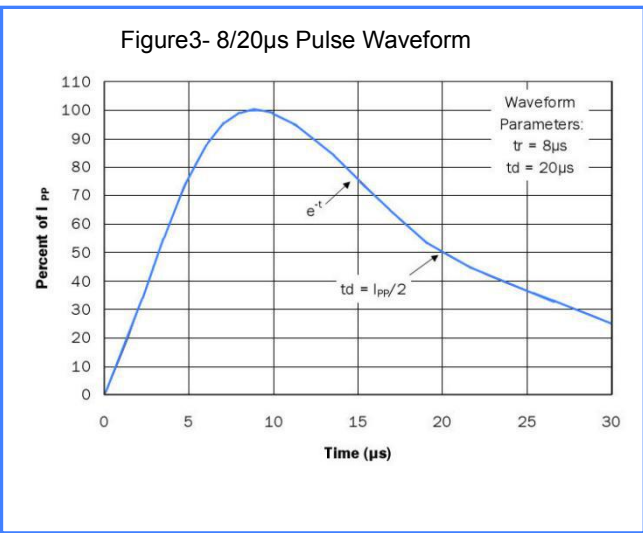
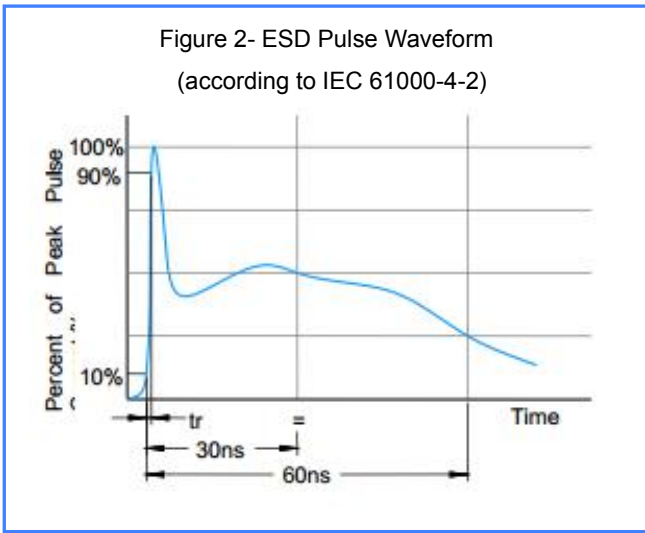
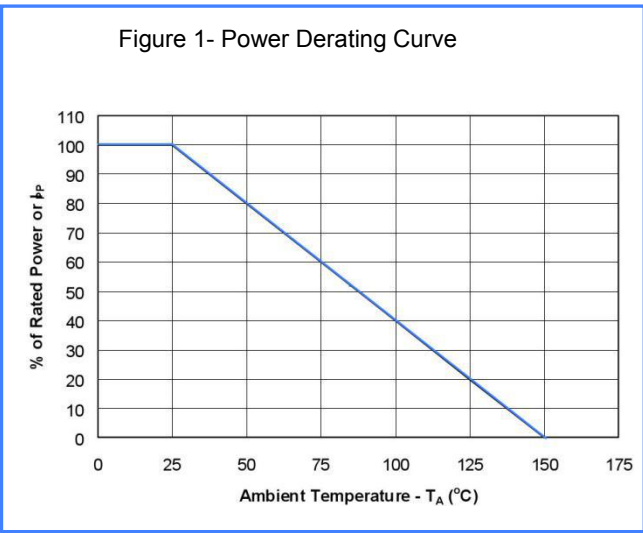

PACKAGE OUTLINE DIMENSIONS in millimeters (inches) :SOT-23

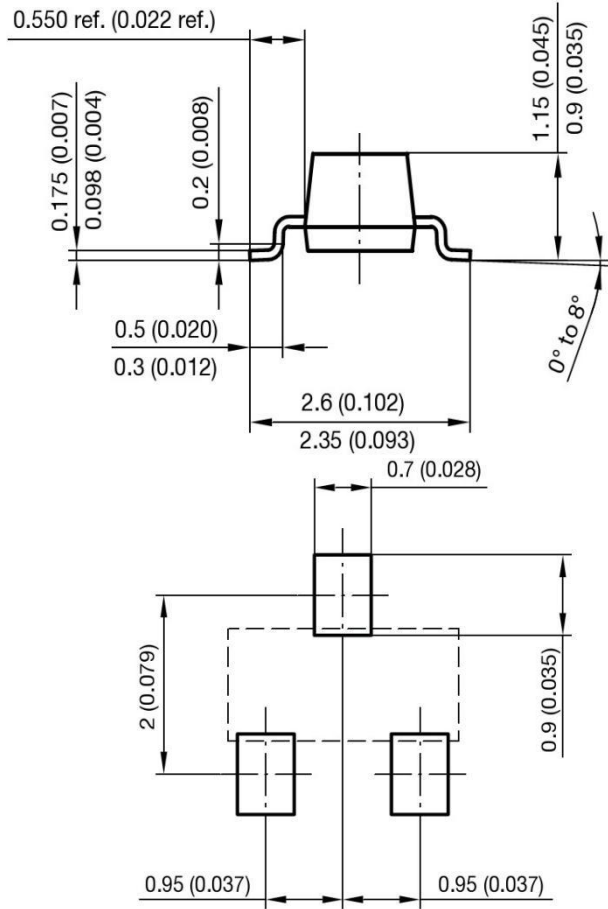
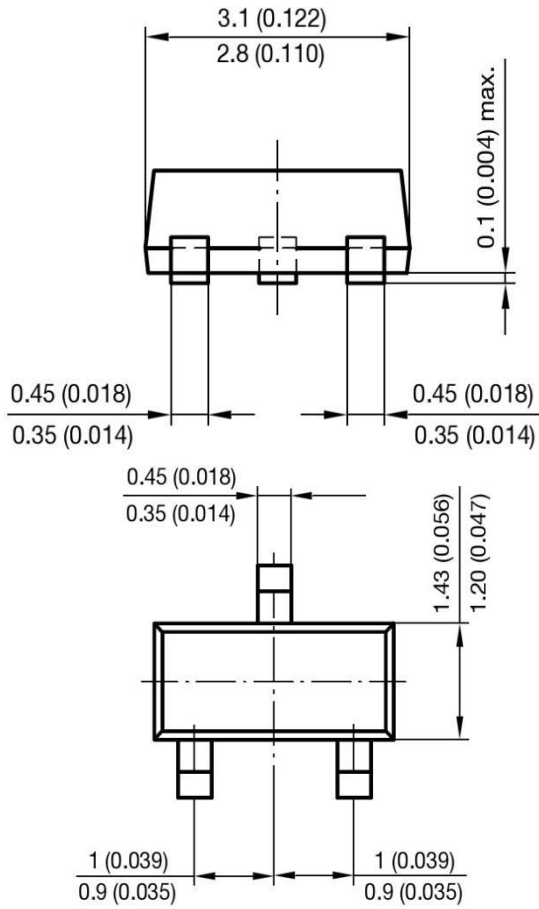

Mounting Pad Layout

Disclaimer

Specifications are subject to change without notice.

The device characteristics and parameters in this data sheet can and do vary in different applications and actual device performance may vary over time.

Users should verify actual device performance in their specific applications.