

## Description

- General small signal amplifier

## PIN Connection

## Features

- Low collector saturation voltage:  
 $V_{CE(sat)} = -0.3V(\text{Max.})$
- Low output capacitance :  $C_{ob} = 4pF(\text{Typ.})$
- Complementary pair with KC5343S

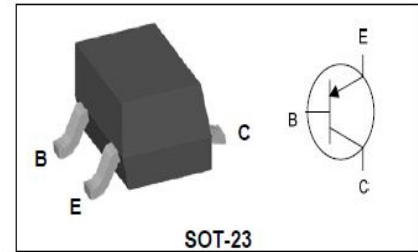

## Ordering Information

Type NO.	Marking	Package Code
KA1980S	CA □ □ ① ② ③	SOT-23

① Device Code ② HFE Grade ③ Year & Week Code • Dalian

## Absolute Maximum Ratings

 $T_a = 25^\circ\text{C}$ 

Characteristic	Symbol	Ratings	Unit
<b>Collector-base voltage</b>	$V_{CBO}$	-50	V
Collector-emitter voltage	$V_{CEO}$	-50	V
Emitter-base voltage	$V_{EBO}$	-5	V
Collector current	$I_C$	-150	mA
Collector power dissipation	$P_C^*$	350	mW
Junction temperature	$T_j$	150	$^\circ\text{C}$
Storage temperature range	$T_{stg}$	-55~150	$^\circ\text{C}$

\* Package mounted on 99.5% alumina  $10 \times 8 \times 0.6\text{mm}$

## Electrical Characteristics

 $T_a = 25^\circ\text{C}$ 

Characteristic	Symbol	Test Condition	Min.	Typ.	Max.	Unit
Collector-emitter breakdown voltage	$BV_{CEO}$	$I_C = -1\text{mA}, I_B = 0$	-50	-	-	V
Collector cut-off current	$I_{CBO}$	$V_{CB} = -50\text{V}, I_E = 0$	-	-	-0.1	$\mu\text{A}$
Emitter cut-off current	$I_{EBO}$	$V_{EB} = -5\text{V}, I_C = 0$	-	-	-0.1	$\mu\text{A}$
DC current gain	$h_{FE}^*$	$V_{CE} = -6\text{V}, I_C = -2\text{mA}$	70	-	700	-
Collector-emitter saturation voltage	$V_{CE(sat)}$	$I_C = -100\text{mA}, I_B = -10\text{mA}$	-	-	-0.3	V
Transition frequency	$f_T$	$V_{CE} = -10\text{V}, I_C = -1\text{mA}$	80	-	-	MHz
Collector output capacitance	$C_{ob}$	$V_{CB} = -10\text{V}, I_E = 0, f = 1\text{MHz}$	-	4	-	pF
Noise figure	NF	$V_{CE} = -6\text{V}, I_C = -0.1\text{mA}$ $f = 1\text{KHz}, R_g = 10\text{K}\Omega$	-	10	-	dB

\*:  $h_{FE}$  rank / O : 70~140, Y : 120~240, G : 200~400, L : 300~700.

## Electrical Characteristic Curves

Fig. 1  $P_C - T_a$

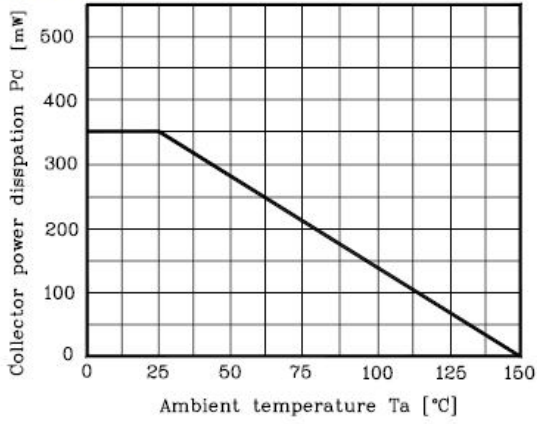

Fig. 2  $I_C - V_{BE}$

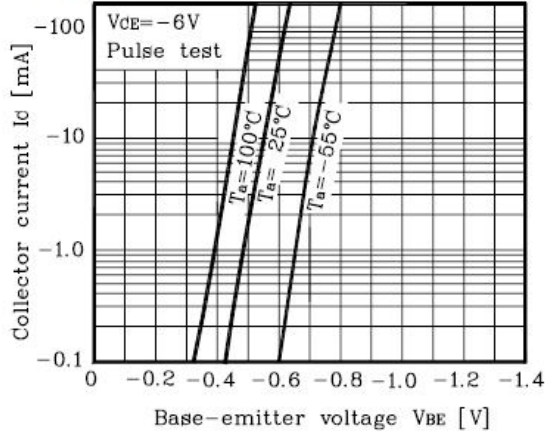

Fig. 3  $I_C - V_{CE}$

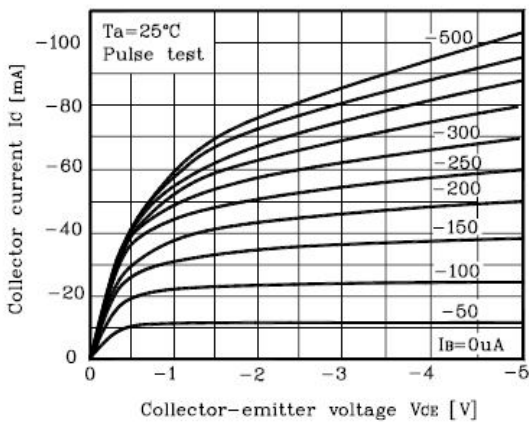

Fig. 4  $h_{FE} - I_C$

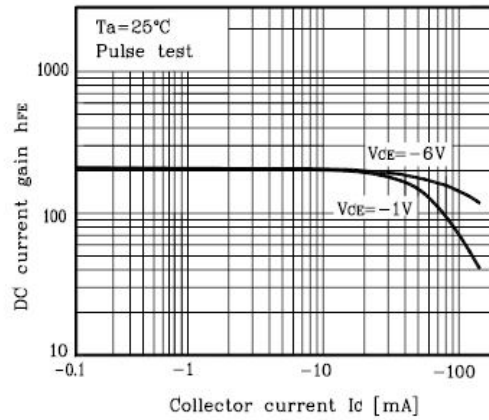
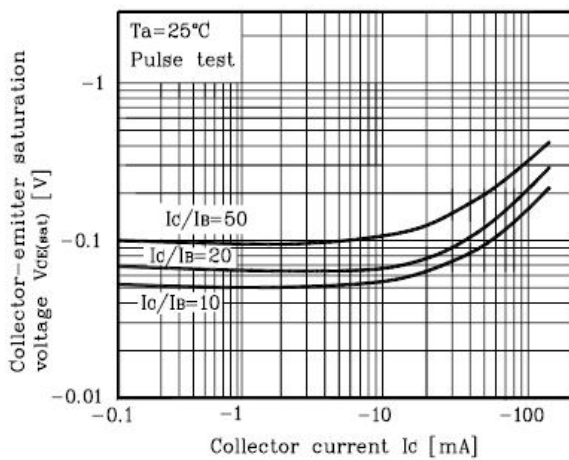
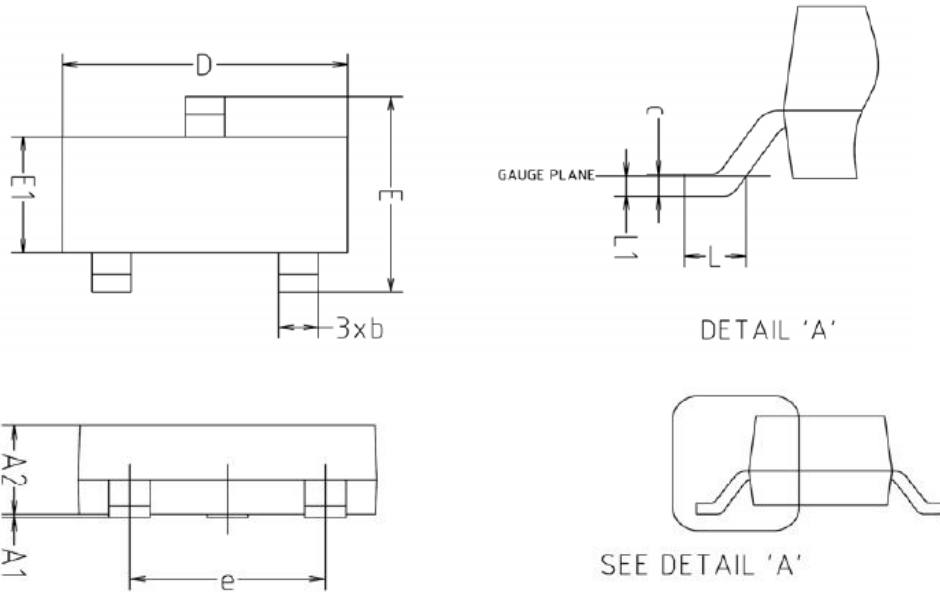

Fig. 5  $V_{CE(sat)} - I_C$



## Outline Dimension



SYMBOL	MILLIMETERS			NOTE
	MINIMUM	NOMINAL	MAXIMUM	
A1	0.00	-	0.10	
A2	0.82	-	1.02	
b	0.39	0.42	0.45	
c	0.09	0.12	0.15	
D	2.80	2.90	3.00	
E	2.20	2.40	2.60	
E1	1.20	1.30	1.40	
e	1.90BSC			
L	0.20	-	-	
L1	0.12BSC			

※Recommend PCB solder land [Unit: mm]

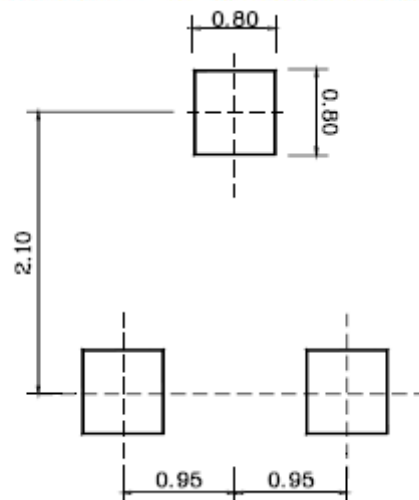

**The AUK Dalian Corp. products are intended for the use as components in general electronic equipment (Office and communication equipment, measuring equipment, home appliance, etc.).**

**Please make sure that you consult with us before you use these AUK Dalian Corp. products in equipments which require high quality and / or reliability, and in equipments which could have major impact to the welfare of human life(atomic energy control, airplane, spaceship, transportation, combustion control, all types of safety device, etc.). AUK Dalian Corp. cannot accept liability to any damage which may occur in case these AUK Dalian Corp. products were used in the mentioned equipments without prior consultation with AUK Dalian Corp..**

**Specifications mentioned in this publication are subject to change without notice.**