



# DATASHEET APLCXX Specification 1.03

Single & Multi-Channel High Performance Sources

9 kHz to 12.75, 20, 40 and 54 GHz



# CONTENTS

<b>Definitions</b> .....	<b>3</b>
<b>Introduction</b> .....	<b>3</b>
<b>Facts &amp; Figures &amp; Specifications</b> .....	<b>4</b>
Signal Specifications .....	4
Frequency Reference .....	4
Absolute Phase Noise .....	5
Spectral Purity .....	6
Phase Coherence .....	7
Level Performance .....	8
Power Level Uncertainty .....	9
Relative Power Error (0.1 dB step) .....	10
Modulation Capabilities .....	11
Sweeping Capability .....	13
Trigger (TRIG IN) .....	14
Multi-Purpose Output (FUNC OUT) .....	14
<b>Connectors</b> .....	<b>15</b>
<b>Ordering Information</b> .....	<b>17</b>
<b>General Characteristics</b> .....	<b>19</b>
<b>Notes</b> .....	<b>21</b>

## DEFINITIONS

The specifications in the following pages describe the warranted performance of the instrument for  $23 \pm 5$  °C after a 30-minute warm-up period

**Typical:** Expected mean values, not warranted performance

**Min and max:** Parameter range that is guaranteed by product design, and/or production tested. Warranted performance specifications include guard-bands to account for the expected statistical performance distribution, measurement uncertainties, and changes in performance due to environmental conditions.

## INTRODUCTION

The APLCxx is a series of phase-coherent, single or multi-channel, ultra-fast switching and ultra-low phase noise signal generators with a frequency range up to 12, 20, 40, and 54 GHz. It is ideally suited for a wide range of applications, where good signal quality, accurate and wide output power ranges, and very stable phase coherence among all channels are required. Excellent phase noise is combined with good spurious, harmonic rejection and optionally leading-edge switching speed of 15  $\mu$ s.

A high-stability OCXO reference provides excellent frequency accuracy and stability. The generator accepts a wide range of external references including the commonly used 10 and 100 MHz for higher phase synchronization, and a flexible reference choice in the range of 1-250 MHz for those applications with customer- or system-specific reference frequencies. Moreover, the APLCxx features a pair of AnaPico-specific high-frequency CLK ports (6 GHz, one input and one output) that enables excellent phase synchronization among the outputs of multiple APLCxx instruments.

The APLCxx(-X) comes in a standard tubus enclosure (single channel) or in a 19 inch 2U (1 up to 4 channels) rack-mountable module form. It can be intuitively controlled by a PC based GUI software. Moreover, the instrument offers various communication interfaces like USB, LAN or GPIB. Each interface allows for easy and fast communication using SCPI 1999 command set. Remote control of the instrument can be quickly achieved from any host system. A customer-supplied application programming interface (API) or programming examples for Matlab, Labview, C++ and other commercially available tools make the control implementation very straightforward.

# FACTS & FIGURES & SPECIFICATIONS

## Signal Specifications

PARAMETER	MIN	TYPICAL	MAX	NOTE
Channels	1		4	
Frequency Ranges				
APLC12	10 MHz		12.75 GHz	
APLC20	10 MHz		20 GHz	
APLC40	10 MHz		40 GHz	
APLC50	10 MHz 9 kHz		54 GHz	<b>Option 9K</b>
Resolution		<0.001 Hz		
Phase Adjustment Range	0 deg		360 deg	individually adjustable per channel
Phase Resolution		0.1 deg		
Deterministic Relative Phase between channels (Phase Memory)				Option PHS
Switching Speed				after SCPI command received
CW Mode		1.5 ms		
Sweep / List Mode		500 $\mu$ s 5 $\mu$ s	15 $\mu$ s	<b>Option FS</b>
Thermal Drift		0.015 dB/°C		

## Frequency Reference

PARAMETER	MIN	TYPICAL	MAX	NOTE
Internal Reference Frequency		100 MHz 10 MHz		<b>Option LN/LN+</b>
Temperature stability 0 to 50 degC			$\pm$ 100 ppb $\pm$ 20 ppb	<b>Option LN/LN+</b>
Aging 1st year			1000 ppb 30 ppb 20 ppb	<b>Option LN</b> <b>Option LN+</b>
Aging per day			5 ppb 0.5 ppb < 0.5 ppb	after 30 days operations <b>Option LN</b> <b>Option LN+</b>
Warm-up time		5 min		
Output of internal reference		10 MHz 100 MHz		REF OUT port, selectable
Output of High Frequency Clock		6 GHz		CLK OUT port high phase synchronous mode
Output power	- 3 dBm 6 dBm		+ 3 dBm +12 dBm	10 MHz, 6 GHz 100 MHz
Output impedance		50 Ohms		
Bypass Internal Reference Input		100, MHz		*Options LN/LN+ are disabled
Phase Lock to External Reference	1 MHz	10 MHz integer MHz	250 MHz	REF IN port <b>Option VREF</b> *Options LN/LN+ are disabled
High Frequency Clock Input (Bypass Internal Reference)		6 GHz		CLK IN port high phase synchronous mode
Reference input level				
10 MHz or 1-250 MHz or 6 GHz	-5 dBm	0 dBm	+10 dBm	
100,	+5 dBm		+13 dBm	
Lock Range				
10 MHz or 1-250 MHz			$\pm$ 1.5 ppm	
Bypass 100 MHz			100 ppm	
Reference Input Impedance		50 Ohms		

**Absolute SSB Phase noise dBc/Hz.**

Specified values in plain text, typical values in brackets. CW, level = 10 dBm o maximum available output power, whichever is lower

OFFSET	10 Hz	100 Hz	1 kHz	20 kHz	100 kHz	1 MHz	10 MHz
<b>FREQUENCY</b>							
<b>100 MHz</b>	-100 (-105)	-130 (-135)	-144 (-149)	-150 (-155)	-156 (-161)	-156 (-161)	-156 (-161)
<b>1 GHz</b>	-80 (-85)	-110 (-115)	-132 (-137)	-145 (-150)	-148 (-153)	-148 (-153)	-155 (-160)
<b>2 GHz</b>	-74 (-79)	-104 (-109)	-126 (-131)	-139 (-141)	-142 (-147)	-142 (-147)	-149 (-154)
<b>3 GHz</b>	-70 (-75)	-100 (-105)	-122 (-127)	-135 (-140)	-138 (-143)	-138 (-143)	-145 (-150)
<b>6 GHz</b>	-64 (-69)	-94 (-99)	-116 (-121)	-129 (-134)	-132 (-137)	-132 (-137)	-139 (-144)
<b>10 GHz</b>	-60 (-65)	-90 (-95)	-117 (-122)	-126 (-131)	-128 (-133)	-126 (-131)	-135 (-140)
<b>20 GHz</b>	-54 (-59)	-84 (-89)	-111 (-116)	-120 (-125)	-122 (-127)	-120 (-125)	-129 (-134)
<b>40 GHz</b>	-48 (-53)	-78 (-83)	-115 (-110)	-114 (-119)	-116 (-121)	-114 (-119)	-123 (-128)
<b>54 GHz</b>	-45 (-50)	-75 (-80)	-100 (-105)	-110 (-115)	-112 (-117)	-112 (-117)	-120 (-125)

**Absolute SSB Phase noise with LN/LN+ option dBc/Hz**

Specified values in plain text, typical values in brackets. CW, level = 10 dBm o maximum available output power, whichever is lower

OFFSET	10 Hz	100 Hz	1 kHz	20 kHz	100 kHz	1 MHz	10 MHz
<b>FREQUENCY</b>							
<b>100 MHz</b>	-116 (-121)	-132 (-137)	-144 (-149)	-150 (-155)	-156 (-161)	-156 (-161)	-156 (-161)
<b>1 GHz</b>	-100 (-105)	-112 (-117)	-132 (-137)	-145 (-150)	-148 (-153)	-148 (-153)	-155 (-160)
<b>2 GHz</b>	-94 (-99)	-106 (-111)	-126 (-131)	-139 (-141)	-142 (-147)	-142 (-147)	-149 (-154)
<b>3 GHz</b>	-90 (-95)	-102 (-107)	-122 (-127)	-135 (-140)	-138 (-143)	-138 (-143)	-145 (-150)
<b>4 GHz</b>	-88 (-93)	-100 (-105)	-120 (-125)	-133 (-135)	-136 (-141)	-136 (-141)	-143 (-148)
<b>6 GHz</b>	-84 (-89)	-96 (-101)	-116 (-121)	-129 (-134)	-132 (-137)	-132 (-137)	-139 (-144)
<b>10 GHz</b>	-80 (-85)	-91 (-96)	-117 (-122)	-126 (-131)	-128 (-133)	-126 (-131)	-135 (-140)
<b>20 GHz</b>	-74 (-79)	-85 (-90)	-111 (-116)	-120 (-125)	-122 (-127)	-120 (-125)	-129 (-134)
<b>40 GHz</b>	-68 (-73)	-79 (-84)	-115 (-110)	-114 (-119)	-116 (-121)	-114 (-119)	-123 (-128)
<b>54 GHz</b>	-63 (-68)	-77 (-82)	-100 (-105)	-110 (-115)	-112 (-117)	-112 (-117)	-120 (-125)

**Figure 1: Phase Noise at different frequencies, power +10 dBm, Option LN**

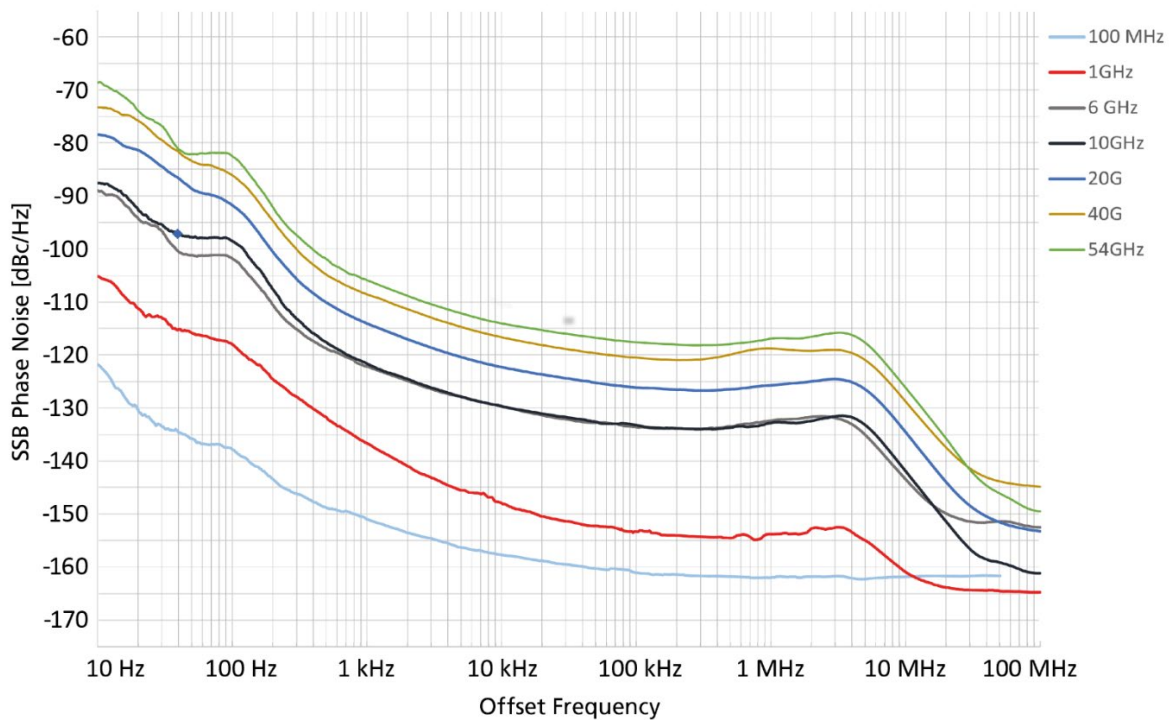
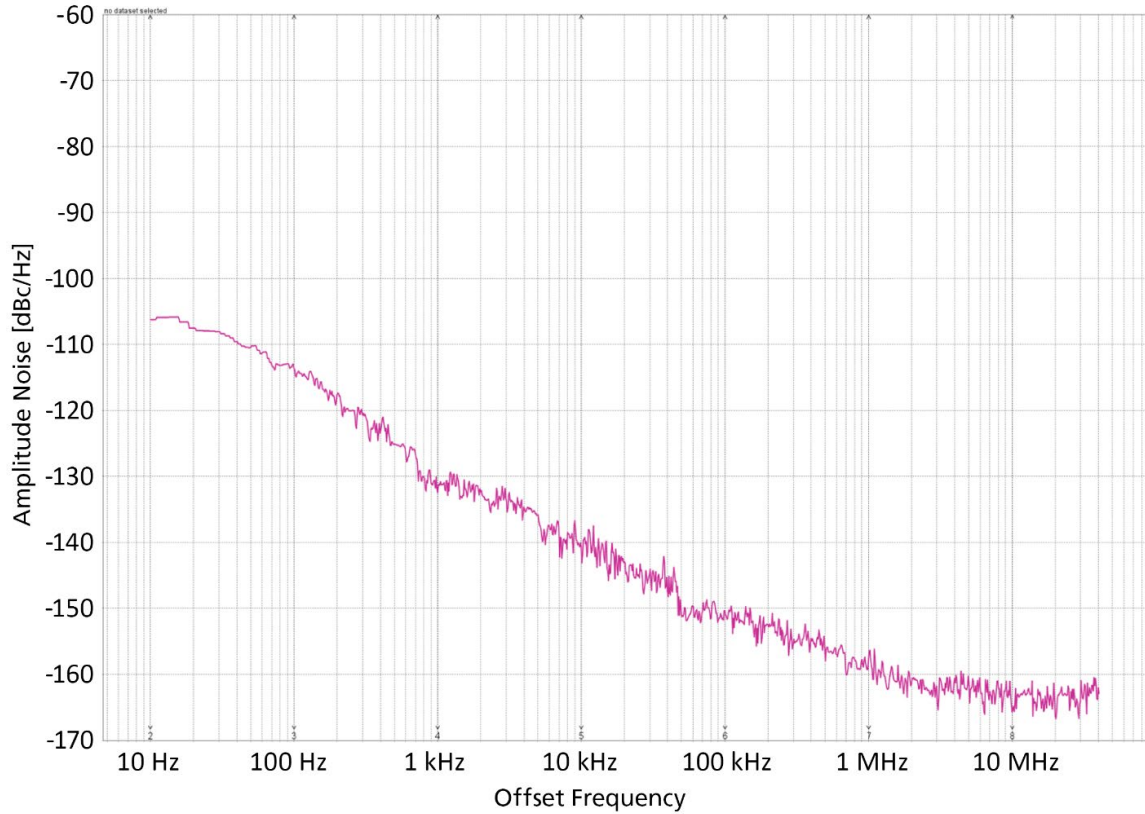

Figure 2: Amplitude Noise at 10 GHz, power +10 dBm



### Spectral Purity

PARAMETER	MIN	TYPICAL	MAX	NOTE
<b>Harmonics</b>				at +5 dBm output power
9 kHz to 150 MHz		-30 dBc		
150 MHz to 2 GHz		-35 dBc	-30 dBc	
2 GHz to 6 GHz		-50 dBc	-45 dBc	
6 GHz to 22 GHz		-55 dBc	-50 dBc	
22 GHz to 30 GHz		-25 dBc	-20 dBc	
30 GHz to 54 GHz		-55 dBc	-50 dBc	
<b>Sub-Harmonics</b>				
9kHz to 100 MHz		-80 dBc		
100 MHz to 11.3 GHz		-70 dBc	-60 dBc	
11.3 GHz to 54 GHz		-70 dBc	-55 dBc	
<b>Non-Harmonic Spurious</b>				10 kHz to 0.5 GHz offset from carrier
< 1.2 GHz		-95 dBc	-85 dBc	
1.2 to 2.5 GHz		-90 dBc	-86 dBc	
2.5 to 6 GHz		-85 dBc	-80 dBc	
6 to 12 GHz		-80 dBc	-74 dBc	
12 to 20 GHz		-75 dBc	-68 dBc	
20 to 40 GHz		-70 dBc	-65 dBc	
40 to 54 GHz		-67 dBc	-62 dBc	

**Figure 3: Harmonics at +10 dBm**

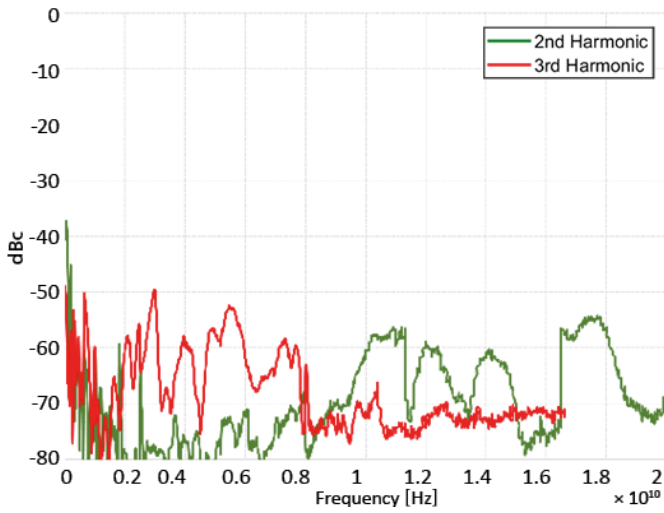

**Figure 4: Non-Harmonic Spurs (12 GHz)**

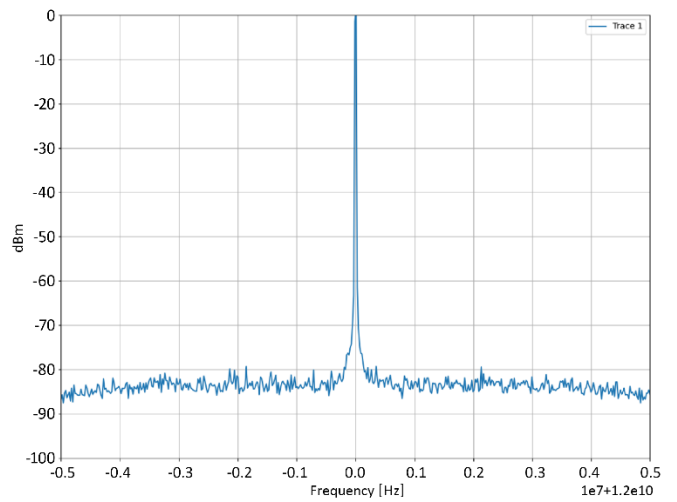

**Figure 5: Non-Harmonics performance at frequencies non-fractional to the reference, 10 001 MHz**

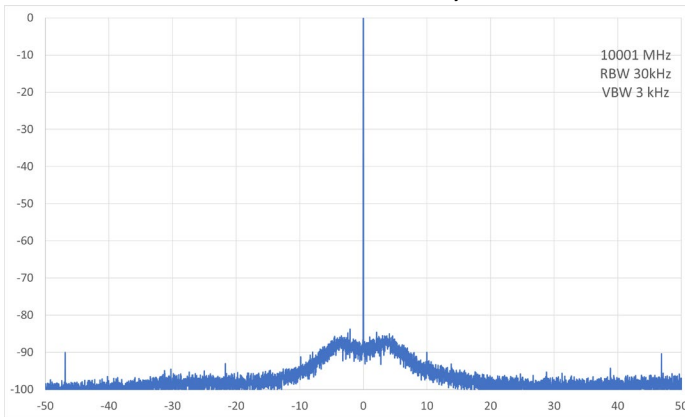

**Figure 6: Non-Harmonics performance at frequencies non-fractional to the reference, 9999 MHz**

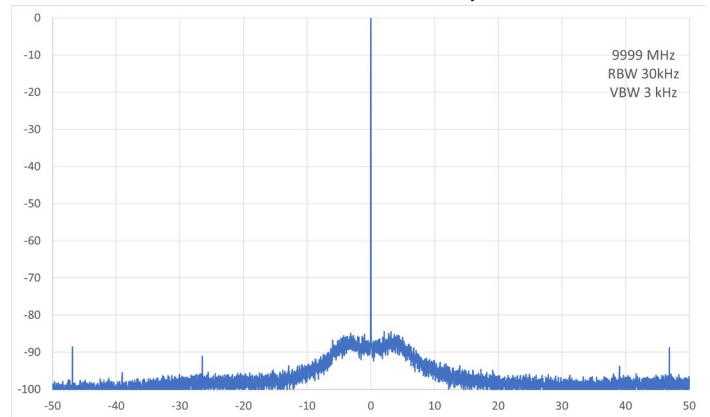

## Phase Coherence

PARAMETER	MIN	TYPICAL	MAX	NOTE
<b>Relative Phase Stability</b>			tba	See plot
Between channels			tba	
Between synchronized Modules			tba	
<b>Phase-Coherent Switching</b>				
Phase mismatch at outputs				
<b>Channel to Channel Performance</b>				
<b>Isolation</b>				
300 kHz to 54 GHz	80 dB	> 90 dB		

**Figure 7: Channel-to-channel Isolation (tba)**

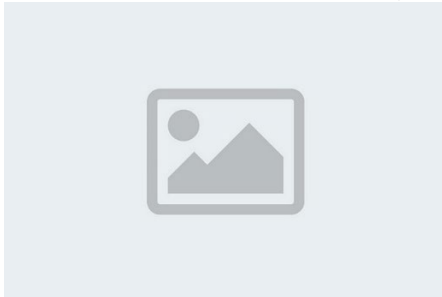

**Figure 8: Relative Channel to channel Phase Stability - Measured at tbd GHz, 10 dBm output in temperature-controlled environment over 10 hours (tba)**

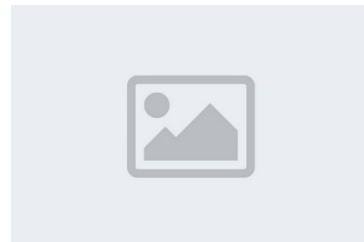



## Level Performance

PARAMETER	MIN	TYPICAL	MAX	NOTE
<b>Output Power Level</b>				
9 kHz to 1 MHz	-20 dBm		+7 dBm	
1 MHz to 10 MHz	-20 dBm		+12 dBm	
10 MHz to 200 MHz	-20 dBm		+17 dBm	
200 MHz to 22 GHz	-20 dBm		+19 dBm	
22 GHz to 42 GHz	-20 dBm		+20 dBm	
42 GHz to 50 GHz	-20 dBm		+15 dBm	
<b>Output Power Level</b>				<b>Option PE2</b>
9 kHz to 1 MHz	-120 dBm		+7 dBm	
1 MHz to 10 MHz	-120 dBm		+12 dBm	
10 MHz to 200 MHz	-120 dBm		+16 dBm	
200 MHz to 22 GHz	-120 dBm		+16 dBm	
22 GHz to 42 GHz	-120 dBm		+16 dBm	
42 GHz to 50 GHz	-120 dBm		+12 dBm	
<b>Power Resolution</b>		0.01 dB		
<b>Reverse Power Protection</b>				
DC Voltage			±10 V	
RF Power			26 dBm	
<b>Output impedance</b>		50 Ohms		
<b>VSWR</b>		1.3	1.5	< 15 GHz
		1.6	1.8	15 to 35 GHz
		1.9	2.2	> 35 GHz

Figure 9: Maxpower 100 MHz to 54 GHz (standard)

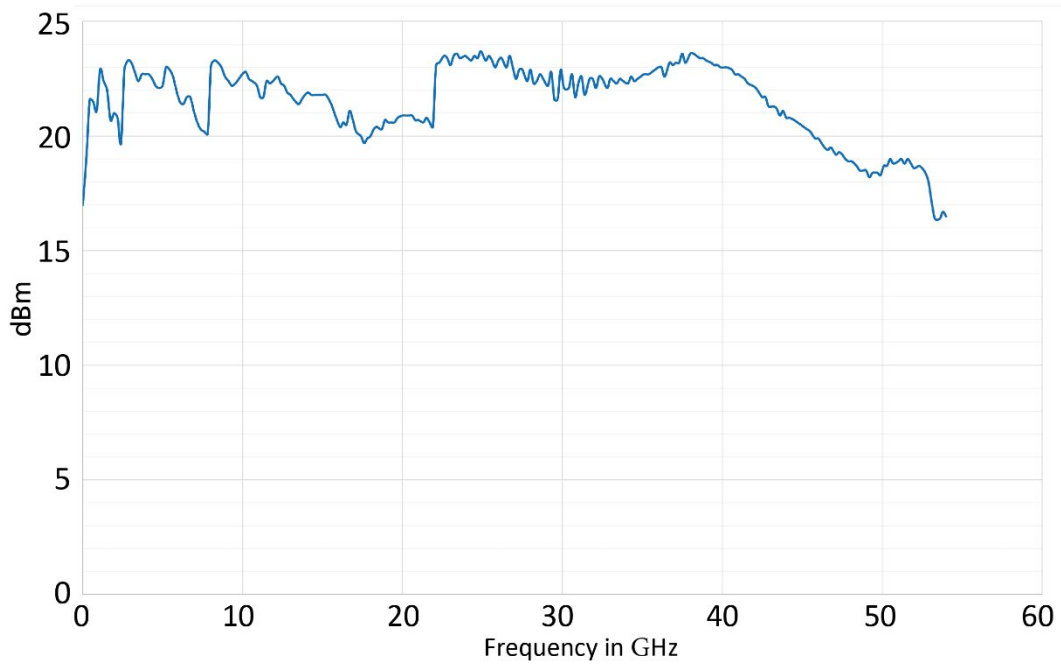
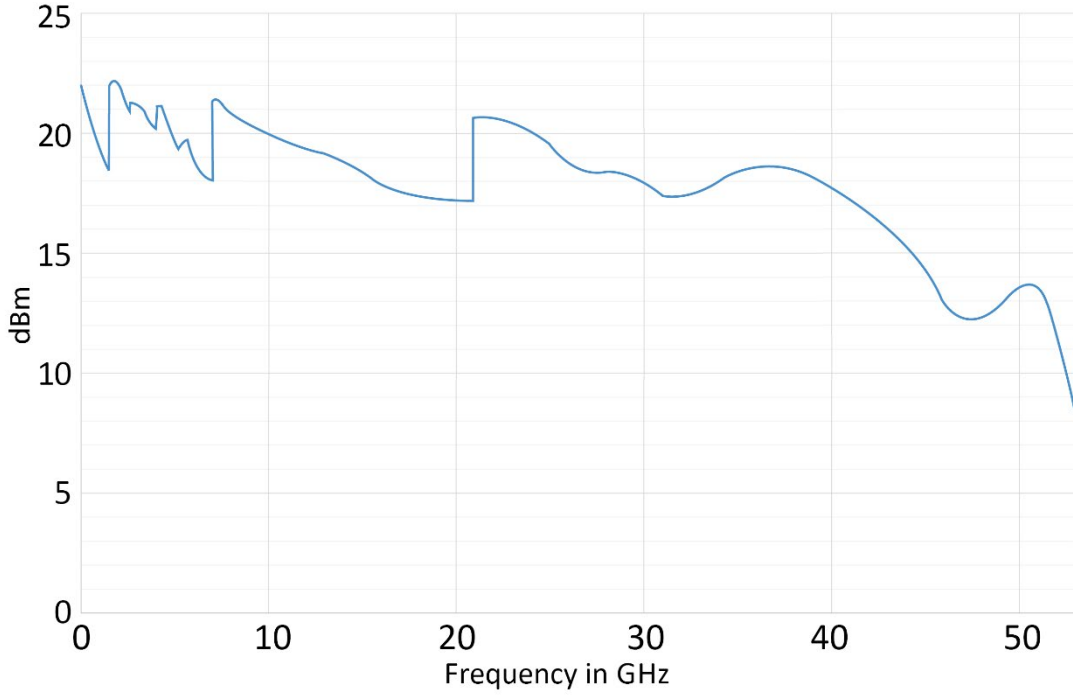



Figure 10: Maxpower 100 MHz to 54 GHz (option PE2)



**Power Level Uncertainty**

( ): Typical value

Frequency Range	-110 to -50 dBm Option PE2	-50 to -15 dBm Option PE2	-15 to +15 dBm	+ 15 dBm to Max Power
300 kHz to 6 GHz	2.0 dB	1.2 dB	0.8 dB (0.3 dB)	1.2 dB
6 to 12 GHz	2.0 dB	1.3 dB	0.9 dB (0.3 dB)	1.3 dB
12 to 20 GHz	2.0 dB	1.8 dB	1.0 dB (0.3 dB)	2.0 dB
20 to 26 GHz	2.3 dB	2.0 dB	1.2 dB (0.4 dB)	2.3 dB
26 to 54 GHz	2.5 dB	2.0 dB	1.3 dB (0.5 dB)	2.5 dB

Figure 11: Level accuracy over frequency (APLC20)

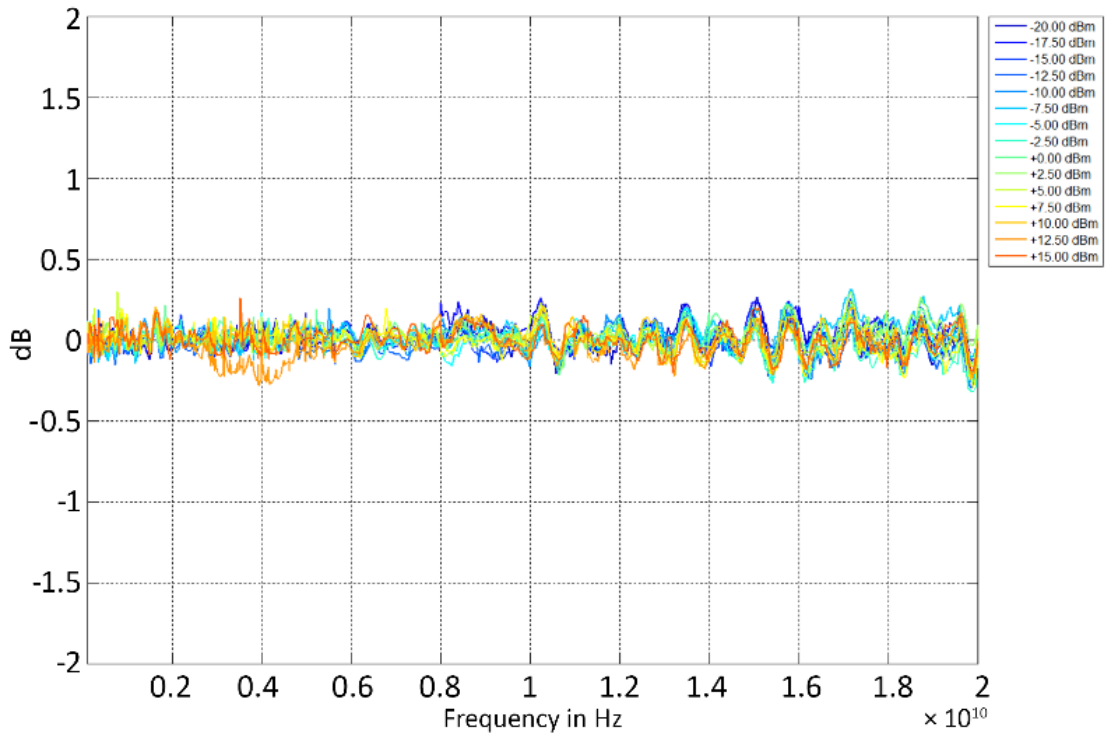

**Figure 12: Level accuracy at low frequency (tba)**

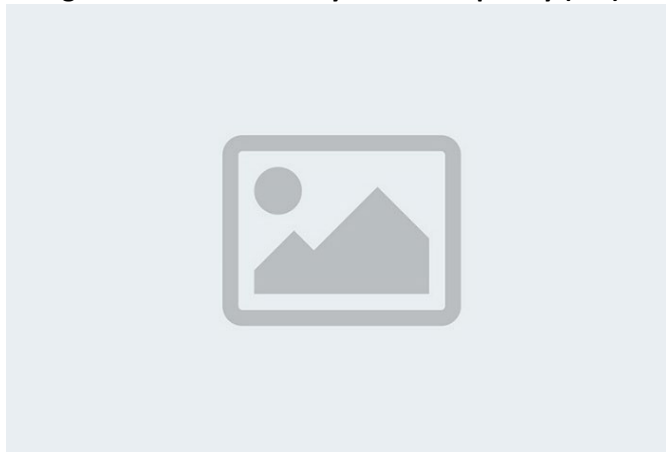

**Figure 13: Power Linearity at different frequencies**

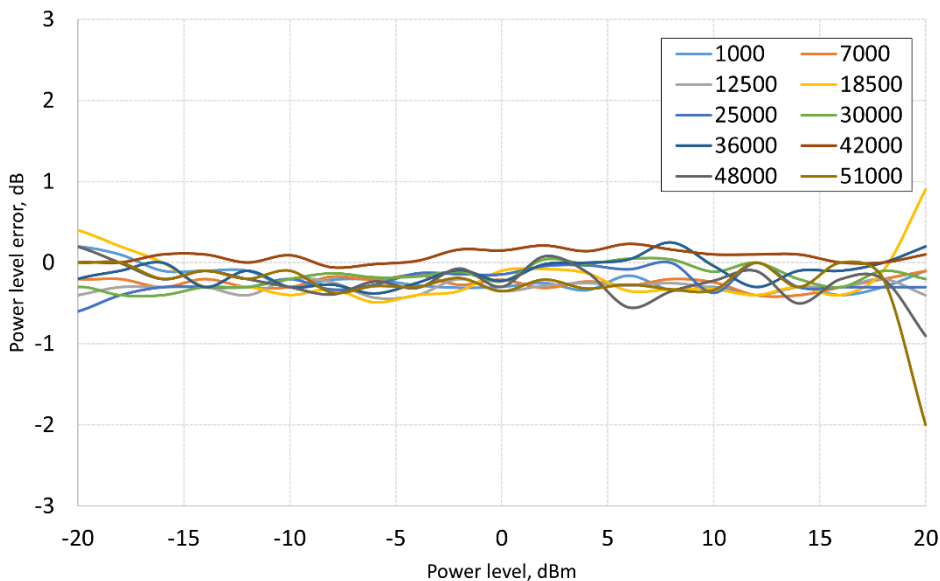

**Relative Power Error (0.1 dB step)**

( ): Typical value

Frequency Range	-110 to -50 dBm Option PE2	-50 to -15 dBm Option PE2	-15 to +15 dBm	+ 15 dBm to Max Power
300 kHz to 20 GHz	(< 0.1 dB)	0.5 dB (< 0.1 dB)	0.5 dB (< 0.1 dB)	(< 0.1 dB)
20 GHz to 26 GHz	(< 0.1 dB)	(< 0.1 dB)	(< 0.1 dB)	(< 0.1 dB)
26 GHz to 54 GHz	(< 0.1 dB)	(< 0.1 dB)	(< 0.1 dB)	(< 0.1 dB)

**Figure 14: Absolute Power error at 54 GHz - Option PE2 (tba)**

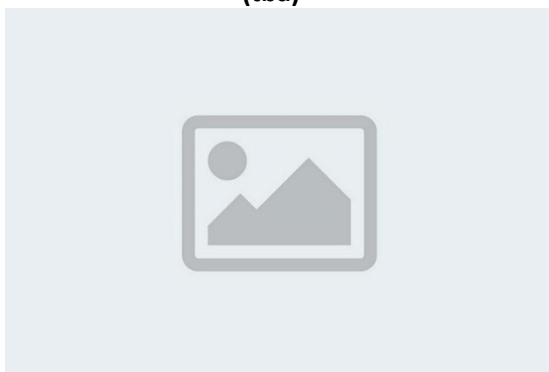

**Figure 15: Relative Power error in 0.1 dB step at 54 GHz - Option PE2 (tba)**

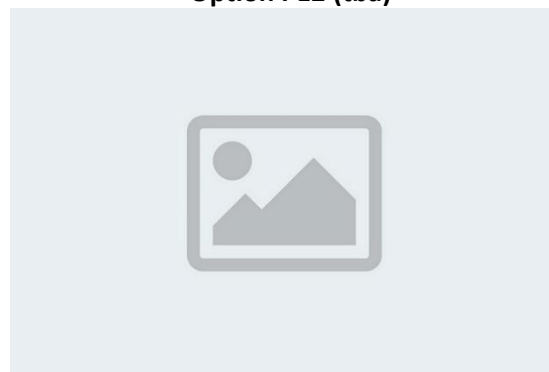



## Modulation Capabilities

PARAMETER	MIN	TYPICAL	MAX	NOTE
<b>Pulse Modulation</b>				
Modulation Source		Internal/ External		
External input amplitude	TTL			
Pulse rise/fall time		3 ns	5 ns	
On/off ratio (power >= +10 dBm)		100 dB	80 dB	
Pulse overshoot			10%	
Pulse delay		20 ns		
Pulse polarity		Normal, inverse		selectable
<b>Internal pulse generator</b>				
Repetition frequency (PRF)	0.1 Hz		50 MHz	= 1/T
Duty cycle	1 % to 99 % in 1% steps			within specified minimum pulse width
Pulse Pattern Modulation & Staggered PRF				using internal pattern generator
Pulse width	100 ns 10 ns		20 s	f < 125 MHz f >= 125 MHz
Programmable pattern length	2		65536	
Duty cycle	0.05%		99.95%	
Pulse width resolution		5 ns		
Pulse period (T) accuracy		0.00005xT+ 3 ns		
Pulse width accuracy		0.00005xT+ 5 ns		
Pulse jitter		2 ns	5 ns	
Polarity		selectable		

**Figure 16: Polarity Pulse On / Off ratio at +10dBm output power and 20 ns pulse**

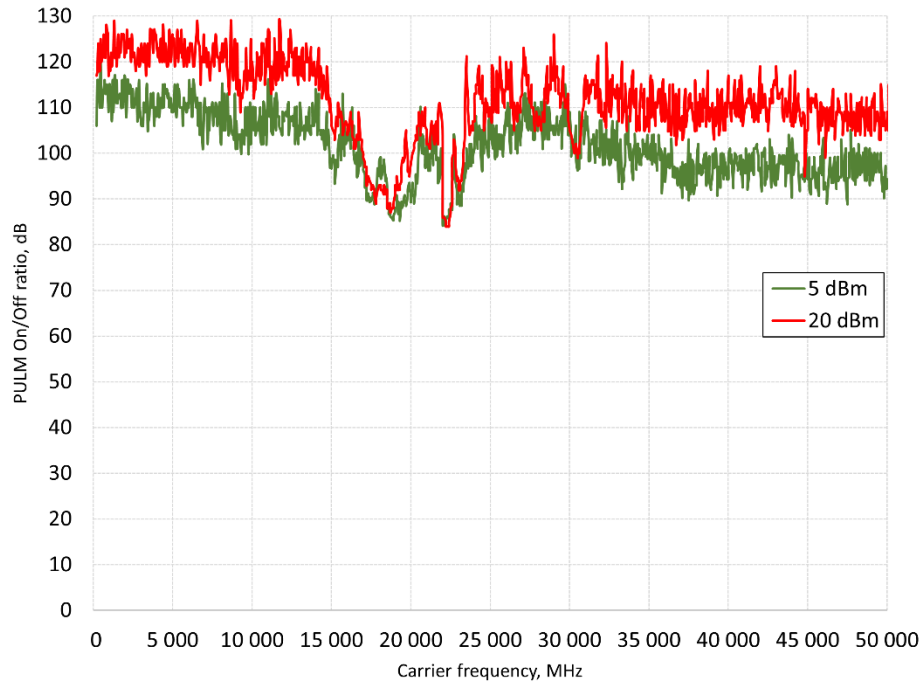

Figure 17: 10 GHz pulse modulation 30 ns

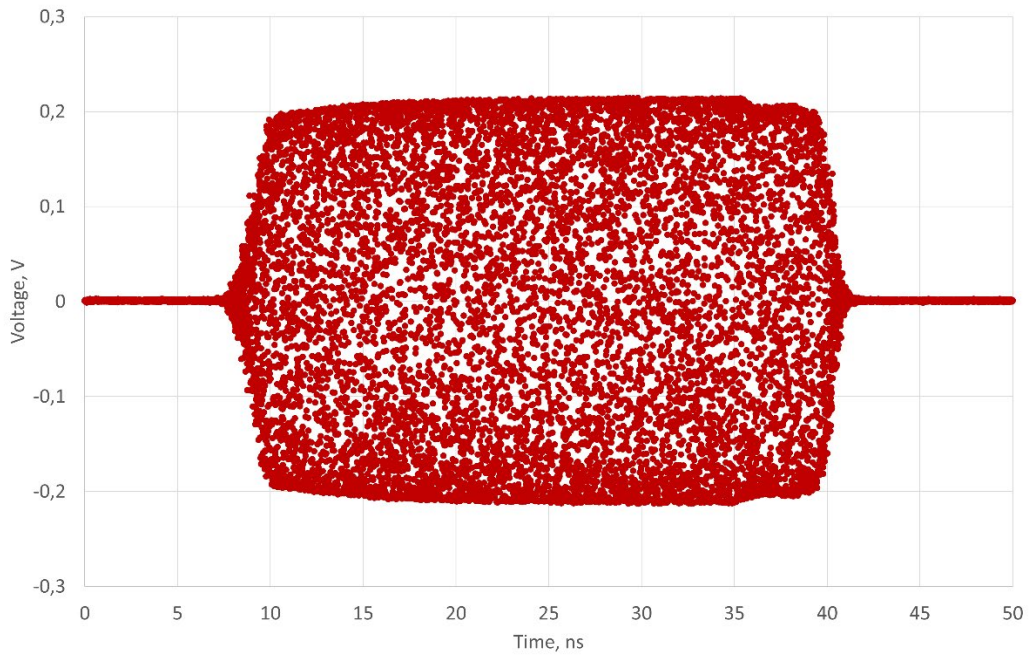
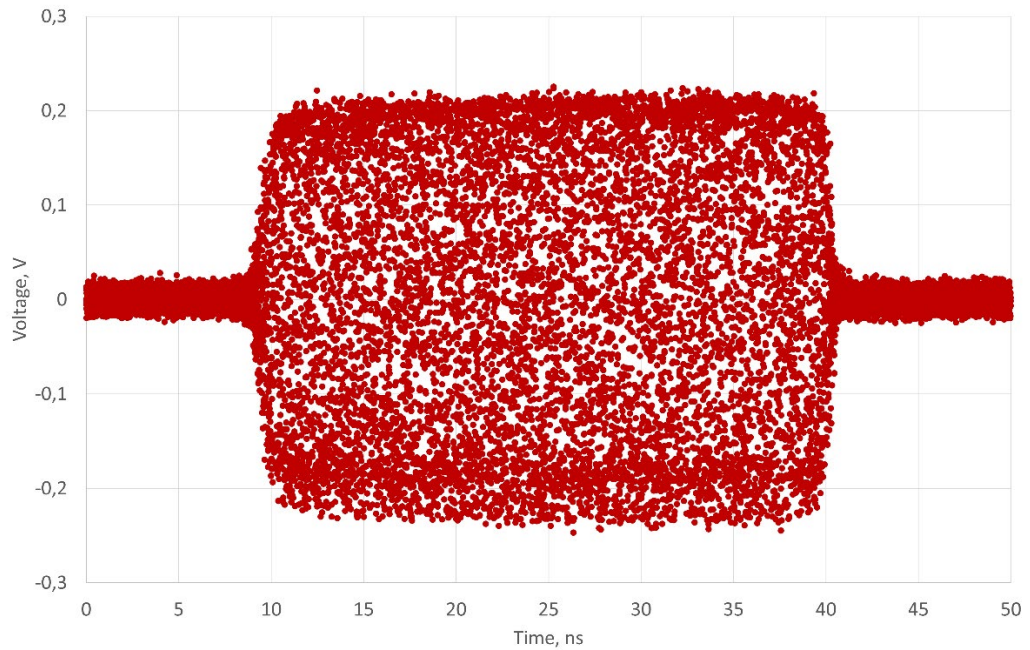

Figure 18: 50 GHz pulse modulation 30 ns



<b>Amplitude Modulation</b>		tbd		<b>Option MOD</b>
Modulation Source		Internal		
Modulation Depth	0%		tbd	
Deviation accuracy		2%	tbd	1 kHz rate, 30% depth
Deviation resolution		1%		
Distortion (THD)			tbd	1 kHz rate, 30% depth
Modulation rate	0.1 Hz		tbd	
Modulation waveforms	Sine			
<b>Frequency Modulation</b>		tbd		<b>Option MOD</b>
Modulation source		Internal		
Maximum Frequency deviation (peak)				

		N · 50 MHz		
Deviation accuracy		0.50%	2%	
Distortion (THD)		< 1 %		1 kHz rate, 10 kHz deviation
Modulation rate	0.1 Hz		30 kHz	
Modulation waveforms	Sine			
<b>Phase Modulation</b>		tbd		<b>Option MOD</b>
Modulation Source		Internal		
Phase deviation (peak)	0		100 · N · rad	
Deviation accuracy		0.50%	2%	
Modulation rate	0.1 Hz		30 kHz	
Modulation waveforms	Sine			
Distortion (THD)	< 1%	1 kHz rate & N x rad deviation		

## Sweeping Capability

PARAMETER	MIN	TYPICAL	MAX	NOTE
<b>Sweep Parameters</b>	Frequency, power, phase, list			
<b>Sweep type</b>	Linear, logarithmic, random			
Step time ( $t_{step} = t_{dwell} + t_{off}$ )	500 $\mu$ s		19998 s	<b>Option FS</b>
	15 $\mu$ s			
Dwell time ( $t_{dwell}$ )	0 $\mu$ s		9999 s	
Off time ( $t_{off}$ )	0 $\mu$ s		9999 s	
Time resolution		5 ns		
Timing delay ( $\tau_{de}$ )		50 ns		
Transient time ( $\tau_{inv}$ )			15 $\mu$ s	
Timing accuracy per point		5 ns		
Number of points	2		10000	Per channel

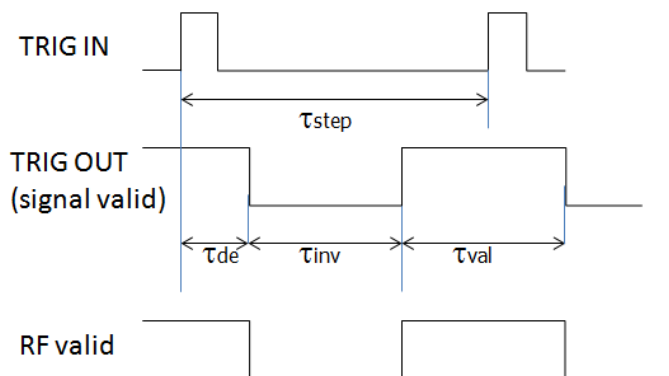



## Trigger (TRIG IN)

PARAMETER	MIN	TYPICAL	MAX	NOTE
Trigger Types		Continuous Single (point) Gated Gated direction		
Trigger Source		External Bus (LAN, USB)		
Trigger Modes		Continuous free run Trigger and run Reset and run		
Trigger latency		5 ns		
Trigger uncertainty		10 ns		
External trigger delay	50 ns		40 s	settable
External delay resolution		5 ns		
Trigger Modulo	1		255	execute only on Nth trigger event
Trigger Polarity		Rising Falling		
External trigger input threshold	0.85 V	0.9 V	0.95 V	TTL compatible
External trigger input voltage range	-0.5 V		+5.5 V	TTL compatible
External trigger input hysteresis		60 mV		



## Multi-Purpose Output (FUNC OUT)

PARAMETER	MIN	TYPICAL	MAX	NOTE
<b>VIDEO OUTPUT (of internal pulse modulator)</b>				
Output		CMOS		
Period	30 ns		50 s	
Pulse width	15 ns		50 s	
RF delay		10 ns		
<b>TRIGGER OUT Synchronization mode for multiple sources</b>				
Modes		Trigger on sweep start Trigger on each point Signal Valid		

## Front panel (19" 2 HU)



- RF outputs:
  - APLC12/20: SMA female
  - APLC40: K female
  - APLC50: 1.85/2.4 mm female
- External pulse modulation inputs: BNC female

## Rear panel (19" 2 HU)



- Unit-to-unit synchronization signal input (SYNC IN): SMA female
- Unit-to-unit synchronization signal output (SYNC OUT): SMA female
- Channel 1, 2, 3, 4 PULM input: BNC female
- Fast control port (FCP): 36-pin mini-D female 3M MDR 102 series
- High Stability Reference input (CLK IN, 6 GHz): SMA female
- High Stability Reference output (CLK OUT, 6 GHz): SMA female
- Trigger input (TRIG IN): BNC female
- Trigger output (TRIG OUT): BNC female
- Reference input (REF IN): BNC female
- Reference output (REF OUT): BNC female
- GPIB: IEEE-488.2, 1987 with listen and talk (optional)
- LAN connection: RJ-45
- USB 2.0 device
- Card slot (SD)
- FUSE (3.15 A)
- 100-240V AC power plug
- Power switch
- Ground reference screw (earth) M4

High Isolation Casing 19" 2HU (rack mount kit included)



Front panel (Desktop enclosure)

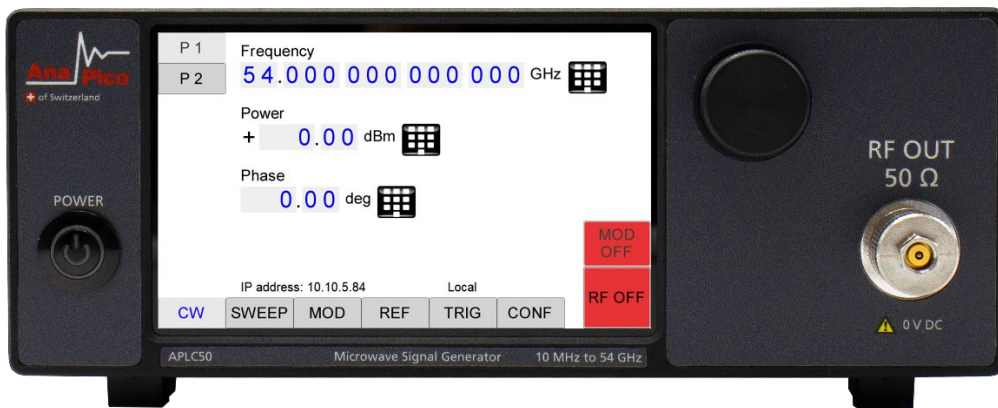

Rear panel (Desktop enclosure)

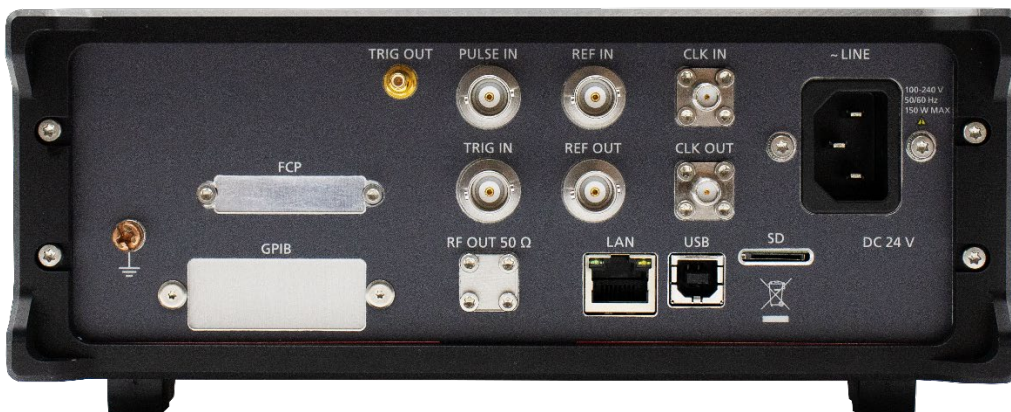



## ORDERING INFORMATION

Host Model No.	Product	Description
APLC	APLC12	High Performance SG up to 12.75 GHz
APLC	APLC20	High Performance SG up to 20 GHz
APLC	APLC40	High Performance SG up to 40 GHz
APLC	APLC50	High Performance SG up to 54 GHz
APLC-XX	APLC12-1	1 channel signal generator, up to 12.75 GHz, 19" 2HU rack-mount module
APLC-XX	APLC12-2	2 channel signal generator, up to 12.75 GHz, 19" 2HU rack-mount module
APLC-XX	APLC12-3	3 channel signal generator, up to 12.75 GHz, 19" 2HU rack-mount module
APLC-XX	APLC12-4	4 channel signal generator, up to 12.75 GHz, 19" 2HU rack-mount module
APLC-XX	APLC20-1	1 channel signal generator, up to 20 GHz, 19" 2HU rack-mount module
APLC-XX	APLC20-2	2 channel signal generator, up to 20 GHz, 19" 2HU rack-mount module
APLC-XX	APLC20-3	3 channel signal generator, up to 20 GHz, 19" 2HU rack-mount module
APLC-XX	APLC20-4	4 channel signal generator, up to 20 GHz, 19" 2HU rack-mount module
APLC-XX	APLC40-1	1 channel signal generator, up to 40 GHz, 19" 2HU rack-mount module
APLC-XX	APLC40-2	2 channel signal generator, up to 40 GHz, 19" 2HU rack-mount module
APLC-XX	APLC40-3	3 channel signal generator, up to 40 GHz, 19" 2HU rack-mount module
APLC-XX	APLC40-4	4 channel signal generator, up to 40 GHz, 19" 2HU rack-mount module
APLC-XX	APLC50-1	1 channel signal generator, up to 54 GHz, 19" 2HU rack-mount module
APLC-XX	APLC50-2	2 channel signal generator, up to 54 GHz, 19" 2HU rack-mount module
APLC-XX	APLC50-3	3 channel signal generator, up to 54 GHz, 19" 2HU rack-mount module
APLC-XX	APLC50-4	4 channel signal generator, up to 54 GHz, 19" 2HU rack-mount module
APLC-XX	<b>Option FS</b>	Ultra-fast switching speed
APLC-XX	<b>Option 9K</b>	Frequency range extension to 9 kHz

<b>APLC-XX</b>	<b>Option LN</b>	Enhanced close in phase noise and frequency stability
<b>APLC-XX</b>	<b>Option LN+</b>	Option LN with improved long term frequency stability
<b>APLC-XX</b>	<b>Option MOD</b>	Analog modulations added
<b>APLC20/40</b>	<b>Option PE2-20/40</b>	Mechanical step attenuator down to -120dBm
<b>APLC-XX</b>	<b>Option PE2-50</b>	Mechanical step attenuator down to -110dBm
<b>APLC-XX</b>	<b>Option PHS</b>	Phase coherent switching
<b>APLC-XX</b>	<b>Option ReCal</b>	Recalibration with test data (recommended: 2 years interval)
<b>APLC-XX</b>	<b>Option VREF</b>	Flexible external reference frequency support in range 1 to 250 MHz
<b>APLC-XX</b>	<b>Option WE</b>	One-year warranty extension (standard: 2 years)
<b>APLC-XX</b>	<b>Option DATA</b>	Commercial Calibration Certificate with test data (per channel)
<b>APLC-XX</b>	<b>Option FLASH</b>	MicroSD card slot for removable SD memory
<b>APLC-XX</b>	<b>Option GPIB</b>	GPIB interface

## GENERAL CHARACTERISTICS

**Remote programming interfaces:**

- 1 Gbit Ethernet interface
- USB 2.0 device
- GPIB (IEEE-488.2,1987) with listen and talk (Option GPIB)
- Control Language SCPI Version 1999.0

**Power requirements:** 100 - 240 VAC, 50 or 60 Hz, 200W maximum (80W + 30W per channel)

**Environmental:** Levels similar to MIL-PRF-28800F Class 3/4



Safety / EMC comply with applicable Safety and EMC regulations and directives.

**Weight:** ≤ 14.0 kg net

**Dimensions:** 19" 2HU HI enclosure

88 mm H x 440 mm W x 500 mm L



