

2A, 18V, 700KHz, Synchronous Step-Down DC/DC Converter

FEATURES

- 4.2V to 18V input voltage
- Output adjustable from 0.807V to 15V
- Output current up to 2A
- Integrated 130mΩ/54mΩ power MOSFET switches
- Shutdown current 3μA typical
- Low IQ Current 180μA typical
- High-Efficiency Synchronous Mode Operation
- Fixed frequency 700KHz
- Power-Save Mode (PSM) at Light Load
- Internal soft start
- Over current protection and Hiccup
- Over temperature protection
- RoHS Compliant and 100% Lead (Pb) Free

APPLICATIONS

- Distributed power systems
- Networking systems
- FPGA, DSP, ASIC power supplies
- Notebook computers
- Green electronics or appliance

ORDERING INFORMATION

PART	PACKAGE	RoHS	Ship, Quantity
ZTP7192C	SOT563	Yes	Tape and Reel

DESCRIPTION

The ZTP7192C is a high-frequency, synchronous, rectified, step-down, switch-mode converter with internal power MOSFETs. It offers a very compact solution to achieve a 2A continuous output current over a wide input supply range, with excellent load and line regulation. The ZTP7192C has synchronous-mode operation for higher efficiency over the output current-load range.

Current-mode operation provides fast transient response and eases loop stabilization.

Protection features include over-current protection, under-voltage protection, short-circuit protection and thermal shutdown.

The ZTP7192C requires a minimal number of readily available, standard external components and is available in space-saving SOT563 (1.6mmx1.6mm) package.

Pins Configuration

Top View
SOT563 (1.6mm x 1.6mm)

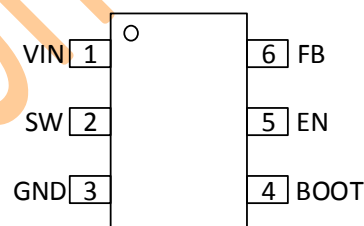

Typical Application Circuit

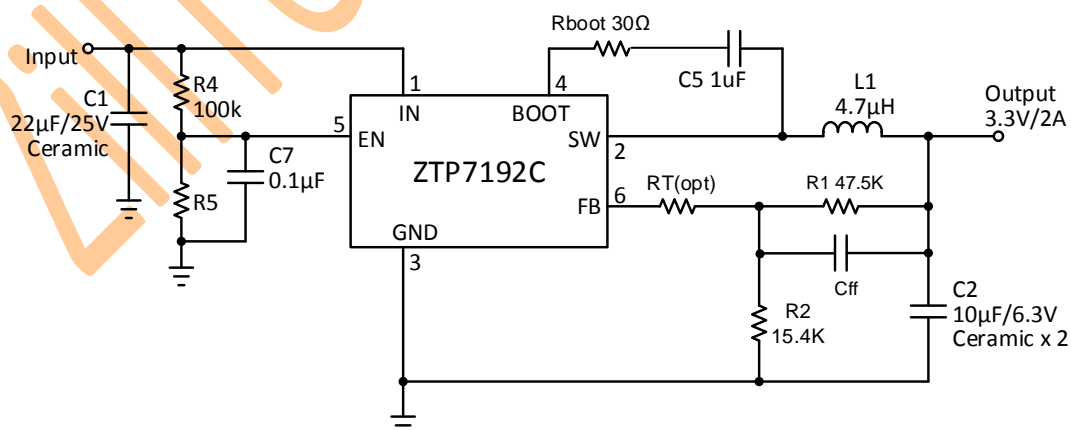

Note1: R5 and C7 are optional.

Note2: Cff are optional. Users can adjust the Cff value according to their bandwidth requirements.

Details please see the DVT report.

Absolute Maximum Ratings

Supply Voltage V_{IN}	-0.3V to +19V
Switch Node V_{SW}	-0.3V to $V_{IN}+0.3V$ -0.3V(-5V for <10nS)to 19V(21V for < 10nS)
Boost V_{BOOT}	$V_{SW}-0.3V$ to $V_{SW}+6V$
All Other Pins	-0.3V to +6V
Power Dissipation @25°C	1W
Junction Temperature	+150°C
Lead Temperature	+260°C
Storage Temperature Range	-65°C to +150°C
ESD, HBM	2KV
ESD, MM	200V

CAUTION: Stresses above those listed in “Absolute Maximum Ratings” may cause permanent damage to the device. This is a stress only rating and operation of the device at these or any other conditions above those indicated in the operational sections of this specification is not implied.

Electro-Static Discharge Sensitivity



This integrated circuit can be damaged by ESD. It is recommended that all integrated circuits be handled with proper precautions. Failure to observe proper handling and installation procedures can cause damage. ESD damage can range from subtle performance degradation to complete device failure.

Recommended Operating Conditions

Supply Voltage V_{IN}	4.2V to 18V
Output Voltage V_{OUT}	0.807V to $V_{IN}-3V$
Operating Temperature Range	-40°C to +125°C

Package Thermal Characteristics

SOT563:

Thermal Resistance, θ_{JA}	130°C/W
Thermal Resistance, θ_{JC}	60°C/W

Measured on JE5D51-7, 4-layer PCB.

Pins Description

SOT563	Symbol	Description
1	IN	Power input.
2	SW	Power switching output.
3	GND	Ground.
4	BOOT	High-side gate drive boost input.
5	EN	Enable input.
6	FB	Feedback input.

Functional Block Diagram

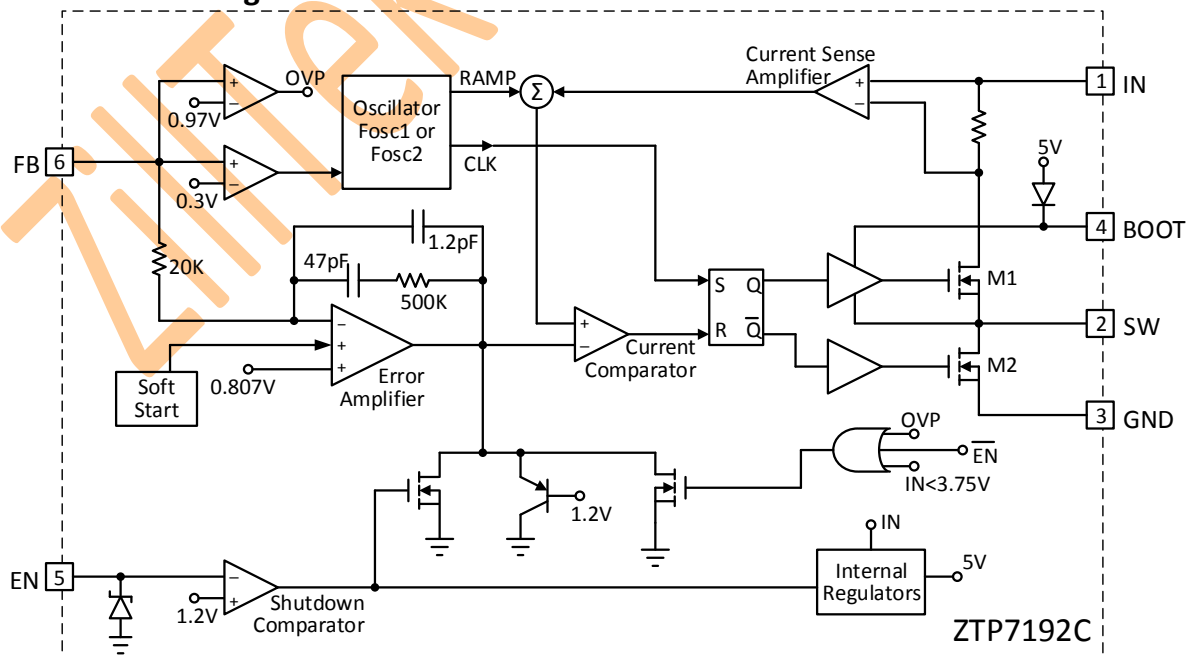

Electrical Specifications

 (T_A = +25°C, V_{IN} = +12V, unless otherwise noted.)

PARAMETER	Symbol	TEST CONDITIONS	MIN	TYP	MAX	UNIT
Supply Voltage	V _{IN}		4.2		18	V
Output Voltage	V _{OUT}		0.807		15	V
Shutdown Supply Current		V _{EN} = 0V		3	6	μA
Supply Current		V _{EN} = 2.0V V _{FB} =0.88V		180		uA
Feedback Voltage	V _{FB}	T _J =-40°C to +125°C	795	807	819	mV
Feedback Over-voltage Threshold	V _{OV_th}			120%		V _{REF}
Feedback Under-voltage Threshold(H to L)	V _{UV_th}			75%		V _{REF}
Error Amplifier Voltage Gain *	A _{EA}			1000		V/V
High-Side Switch-On Resistance *	R _{DS(ON)1}	V _{BOOT-SW} =5V		130		mΩ
Low-side Switch-On Resistance *	R _{DS(ON)2}			54		mΩ
High-Side Switch Leakage Current		V _{EN} = 0V, V _{SW} = 0V, T _A = +125°C			10	μA
Upper Switch Current Limit		Minimum Duty Cycle	3	3.6		A
Lower Switch Current Limit		From Drain to Source		0		A
Oscillation Frequency	F _{OSC1}			700		KHz
Short Circuit Oscillation Frequency	F _{OSC2}	V _{FB} = 0V		350		KHz
Maximum Duty Cycle	D _{MAX}	V _{FB} = 0.5V		90		%
Minimum On Time *				65		ns
EN Falling Threshold Voltage		V _{EN} Falling	1.04	1.1	1.16	V
EN Rising Threshold Voltage		V _{EN} Rising	1.14	1.2	1.26	V
Input Under Voltage Lockout Threshold		V _{IN} Rising	3.7	4	4.18	V
Input Under Voltage Lockout Threshold Hysteresis				330		mV
Soft-Start Period				2.5		ms
Thermal Shutdown *				150		°C
Thermal Hysteresis				20		°C

* Guaranteed by design, not tested.

Typical Characteristics

$V_{IN} = 12V$, $V_O = 3.3V$, $L1 = 4.7\mu H$, $C1 = 10\mu F$, $C2 = 10\mu F \times 2$, $T_A = +25^\circ C$, unless otherwise noted.

Start UP ($I_{Load}=1A$)

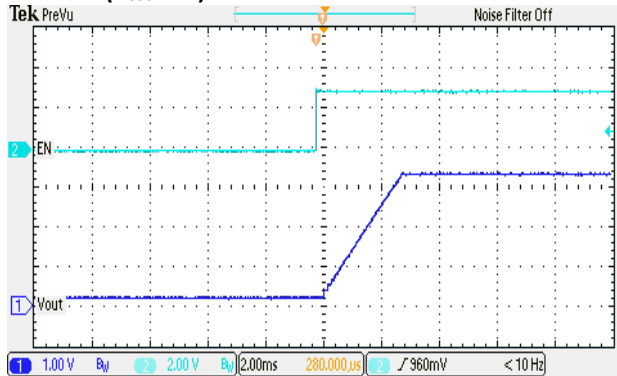

Shut Down ($I_{Load}=1A$)

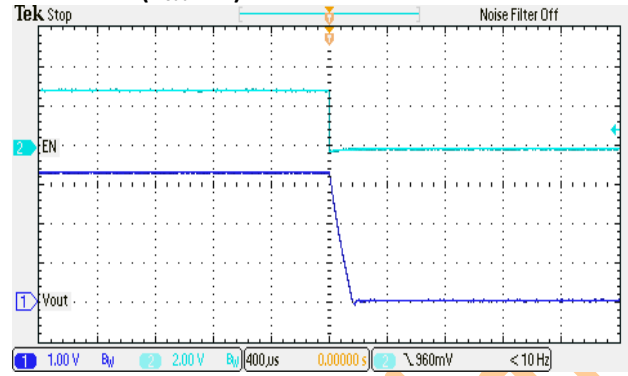

Output Ripple ($I_{Load}=2A$)

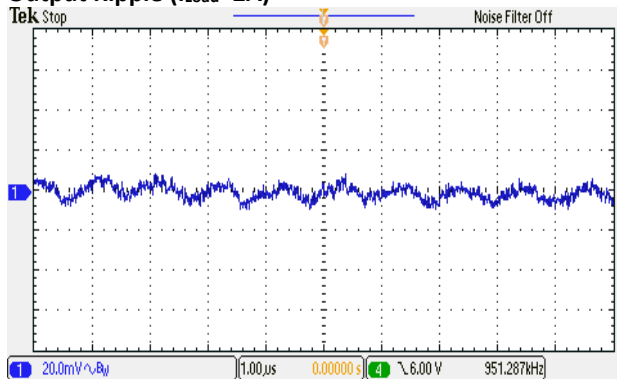

Output Ripple ($I_{Load}=1A$)

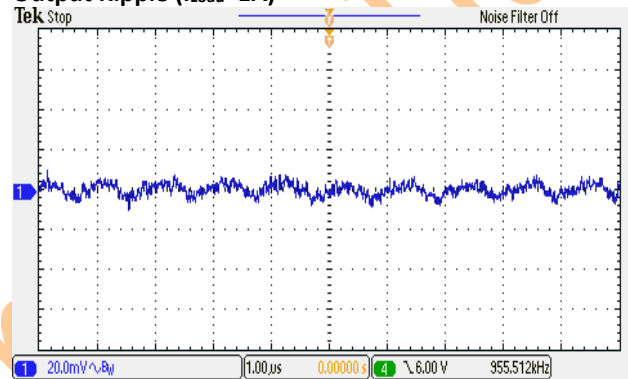

Output Ripple ($I_{Load}=0A$)

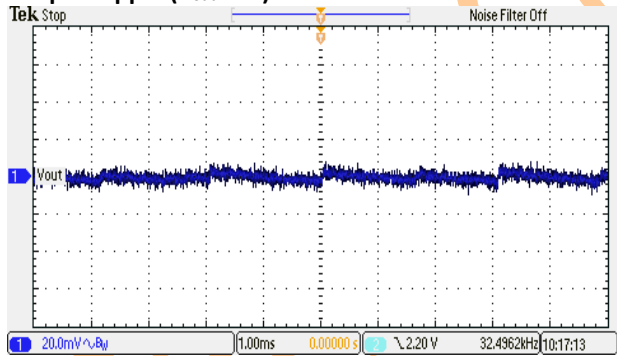

Dynamic Load ($I_{Load}=0.2A_1.2A$)

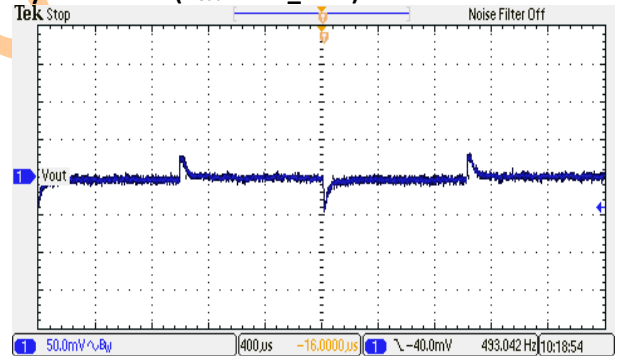

Short Circuit Protection

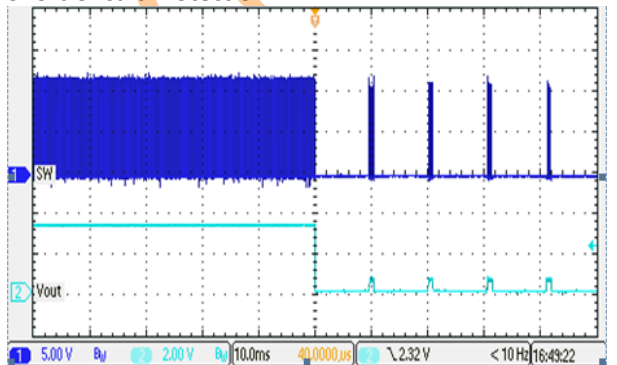

Efficiency

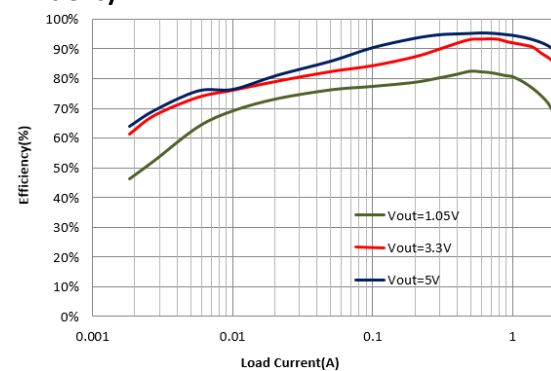

APPLICATION INFORMATION

Overview

The ZTP7192C is a synchronous rectified, current-mode, step-down regulator. It regulates input voltages from 4.2V to 18V down to an output voltage as low as 0.807V, and supplies up to 2A of load current.

The ZTP7192C uses current-mode control to regulate the output voltage. The output voltage is measured at FB through a resistive voltage divider and amplified through the internal trans-conductance error amplifier.

The converter uses internal N-Channel MOSFET switches to step-down the input voltage to the regulated output voltage. Since the high side MOSFET requires a gate voltage greater than the input voltage, a boost capacitor connected between SW and BOOT is needed to drive the high side gate. The boost capacitor is charged from the internal 5V rail when SW is low.

The ZTP7192C has power save mode for light load. During this time, the internal clock is blocked, thus the ZTP7192C skips some pulses for PFM(Pulse Frequency Modulation) mode and achieves the light load power save.

When the ZTP7192C FB pin exceeds 20% of the nominal regulation voltage of 0.807V, the over voltage comparator is tripped, forcing the high-side switch off.

Pins Description

BOOT: High-Side Gate Drive Boost Input. BOOT supplies the drive for the high-side N-Channel MOSFET switch. Connect a 0.1μF or greater capacitor from SW to BOOT to power the high side switch.

IN: Power Input. IN supplies the power to the IC, as well as the step-down converter switches. Drive IN with a 4.2V to 18V power source. Bypass IN to GND with a suitably large capacitor to eliminate noise on the input to the IC.

SW: Power Switching Output. SW is the switching node that supplies power to the output. Connect the output LC filter from SW to the output load. Note that a capacitor is required from SW to BOOT to power the high-side switch.

GND: Ground.

FB: Feedback Input. FB senses the output voltage to regulate that voltage. Drive FB with a resistive voltage divider from the output voltage. The feedback threshold is 0.807V.

EN: Enable Input. EN is a digital input that turns the regulator on or off. Drive EN high to turn on the regulator, drive it low to turn it off. Pull up with 100kΩ resistor for automatic startup.

Setting the Output Voltage

The external resistor divider sets the output voltage. The feedback resistor R1 also sets the feedback-loop bandwidth through the internal compensation capacitor (see the Typical Application circuit). Choose R1 around 10kΩ, and R2 by:

$$R2 = R1 / (V_{OUT}/0.807V - 1)$$

Use a network below for when V_{OUT} is low.

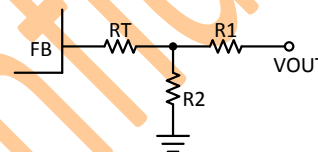

Figure 1: Network.

Table 1 lists the recommended T-type resistors value for common output voltages.(RT=0)

V _{OUT} (V)	R1 (KΩ)	R2 (KΩ)	Rt (Ω)
1.05	103.8(1%)	344.7(1%)	0(1%)
1.2	100.0(1%)	205.3(1%)	0(1%)
1.8	85.0(1%)	69.1(1%)	0(1%)
2.5	67.5(1%)	32.2(1%)	0(1%)
3.3	47.5(1%)	15.4(1%)	0(1%)
5	83.1(1%)	16.0(1%)	0(1%)

Table 1: Resistor selection for common output voltages.

Rt is used to set control loop's bandwidth, which is proportional to the relation by R1, R2, RT:

$$1/[(Rt+20k)*(1+R1/R2)+R1]$$

So Increase RT & Decrease R1&R2 value(keeping R1/R2 ratio), the bandwidth can be kept the same(the relation value need to be the same)

Inductor

The inductor is required to supply constant current to the output load while being driven by the switched input voltage. A larger value inductor will result in less ripple current that will result in lower output ripple voltage. However, the larger value inductor will have a larger physical size, higher series resistance, and/or lower saturation current. A good rule for determining the inductance to use is to allow the peak-to-peak ripple current in the inductor to be approximately 30% of the maximum switch current limit. Also, make sure that the peak inductor current is below the maximum switch current limit. The inductance value can be calculated by:

$$L = [V_{OUT} / (f_s \times \Delta I_L)] \times (1 - V_{OUT}/V_{IN})$$

Where V_{OUT} is the output voltage, V_{IN} is the input voltage, f_s is the switching frequency, and ΔI_L is the peak-to-peak inductor ripple current.

Choose an inductor that will not saturate under the maximum inductor peak current. The peak inductor current can be calculated by:

$$I_{LP} = I_{LOAD} + [V_{OUT} / (2 \times f_s \times L)] \times (1 - V_{OUT}/V_{IN})$$

Where I_{LOAD} is the load current.

The choice of which style inductor to use mainly depends on the price vs. size requirements and any EMI requirements.

Optional Schottky Diode

During the transition between high-side switch and low-side switch, the body diode of the low-side power MOSFET conducts the inductor current. The forward voltage of this body diode is high. An optional Schottky diode may be paralleled between the SW pin and GND pin to improve overall efficiency. Table 2 lists example Schottky diodes and their Manufacturers.

Part Number	Voltage and Current Rating	Vendor
B130	30V, 1A	Diodes Inc.
SK13	30V, 1A	Diodes Inc.
MBRS130	30V, 1A	International Rectifier

Table 2: Diode selection guide.

Input Capacitor

The input current to the step-down converter is discontinuous, therefore a capacitor is required to supply the AC current to the step-down converter while maintaining the DC input voltage. Use low ESR capacitors for the best performance. Ceramic capacitors

are preferred, but tantalum or low-ESR electrolytic capacitors may also suffice. Choose X5R or X7R dielectrics when using ceramic capacitors.

Since the input capacitor (C_1) absorbs the input switching current it requires an adequate ripple current rating. The RMS current in the input capacitor can be estimated by:

$$I_{C1} = I_{LOAD} \times [(V_{OUT}/V_{IN}) \times (1 - V_{OUT}/V_{IN})]^{1/2}$$

The worst-case condition occurs at $V_{IN} = 2V_{OUT}$, where $I_{C1} = I_{LOAD}/2$. For simplification, choose the input capacitor whose RMS current rating greater than half of the maximum load current.

The input capacitor can be electrolytic, tantalum or ceramic. When using electrolytic or tantalum capacitors, a small, high quality ceramic capacitor, i.e. 0.1 μ F, should be placed as close to the IC as possible. When using ceramic capacitors, make sure that they have enough capacitance to provide sufficient charge to prevent excessive voltage ripple at input. The input voltage ripple for low ESR capacitors can be estimated by:

$$\Delta V_{IN} = [I_{LOAD}/(C_1 \times f_s)] \times (V_{OUT}/V_{IN}) \times (1 - V_{OUT}/V_{IN})$$

Where C_1 is the input capacitance value.

Output Capacitor

The output capacitor is required to maintain the DC output voltage. Ceramic, tantalum, or low ESR electrolytic capacitors are recommended. Low ESR capacitors are preferred to keep the output voltage ripple low. The output voltage ripple can be estimated by:

$$\Delta V_{OUT} = [V_{OUT}/(f_s \times L)] \times (1 - V_{OUT}/V_{IN}) \times [R_{ESR} + 1 / (8 \times f_s \times C_2)]$$

Where C_2 is the output capacitance value and R_{ESR} is the equivalent series resistance (ESR) value of the output capacitor.

In the case of ceramic capacitors, the impedance at the switching frequency is dominated by the capacitance. The output voltage ripple is mainly caused by the capacitance. For simplification, the output voltage ripple can be estimated by:

$$\Delta V_{OUT} = [V_{OUT}/(8 \times f_s^2 \times L \times C_2)] \times (1 - V_{OUT}/V_{IN})$$

In the case of tantalum or electrolytic capacitors, the ESR dominates the impedance at the switching frequency. For simplification, the output ripple can be approximated to:

$$\Delta V_{OUT} = [V_{OUT}/(f_s \times L)] \times (1 - V_{OUT}/V_{IN}) \times R_{ESR}$$

The characteristics of the output capacitor also affect the stability of the regulation system. The ZTP7192C can be optimized for a wide range of capacitance and ESR values.

External Bootstrap Diode

An external bootstrap diode may enhance the efficiency of the regulator, the applicable conditions of external BOOT diode are:

- $V_{OUT} = 5V$ or $3.3V$; and
- Duty cycle is high: $D = V_{OUT}/V_{IN} > 65\%$

In these cases, an external BOOT diode is recommended from the output of the voltage regulator to BOOT pin, as shown in Figure 2.

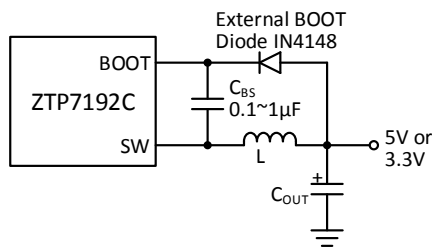

Figure 2: Add optional external bootstrap diode to enhance efficiency.

The recommended external BOOT diode is IN4148, and the BOOT capacitor is $0.1 \sim 1\mu F$.

When $V_{IN} \leq 6V$, for the purpose of promote the efficiency, it can add an external Schottky diode between IN and BOOT pins, as shown in Figure 3.

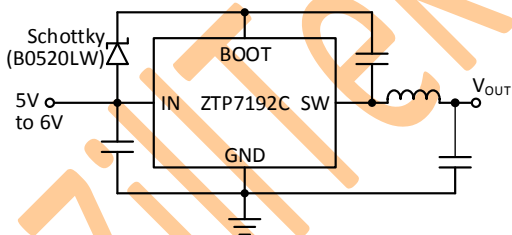

Figure 3: Add a Schottky diode to promote efficiency when $V_{IN} \leq 6V$.

PCB Layout Guide

PCB layout is very important to achieve stable operation. Please follow the guidelines below.

- 1) Keep the path of switching current short and minimize the loop area formed by Input capacitor, high-side MOSFET and low-side MOSFET.
- 2) Bypass ceramic capacitors are suggested to be put close to the V_{IN} Pin.
- 3) Ensure all feedback connections are short and direct. Place the feedback resistors and compensation components as close to the chip as possible.
- 4) Rout SW away from sensitive analog areas such as FB.
- 5) Connect IN, SW, and especially GND respectively to a large copper area to cool the chip to improve thermal performance and long-term reliability.
- 6) It is recommended to reserve a place for Cff in layout.

BOM of ZTP7192C

Please refer to the Typical Application Circuit.

Item	Reference	Part
1	C1	22µF
2	C5	1uF
3	C7	0.1µF
4	R4	100K

Table 3: BOM selection table I.

	L1	R1	R2	C2
$V_{out} = 5.0V$	4.7µH	83.1K	16.0K	10µF×2
$V_{out} = 3.3V$	4.7µH	47.5K	15.4K	10µF×2
$V_{out} = 2.5V$	3.3µH	67.5K	32.2K	10µF×2
$V_{out} = 1.8V$	2.2µH	85.0K	69.1K	10µF×2
$V_{out} = 1.2V$	2.2µH	100.0K	205.3K	10µF×2
$V_{out} = 1.05V$	1.5µH	103.8K	344.7K	10µF×2

Table 4: BOM selection table II.

PACKAGE DIMENSION SOT563 (1.6mmx1.6mm)

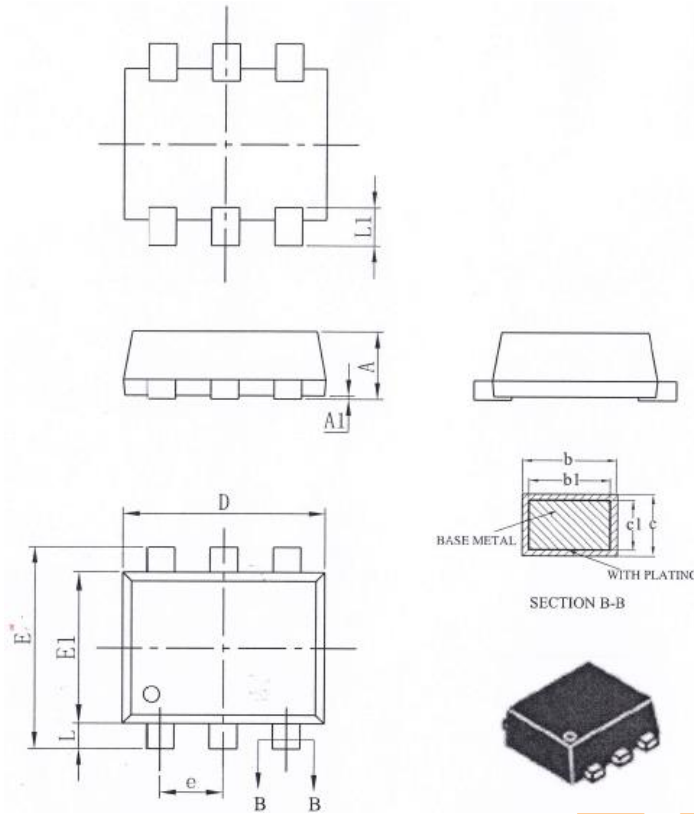

SYMBOL	MILLIMETER		
	MIN	NOM	MAX
A	0.53	—	0.60
A1	0.00	—	0.05
b	0.19	—	0.27
b1	0.18	0.20	0.23
c	0.11	—	0.16
c1	0.10	0.11	0.12
D	1.50	1.60	1.70
E	1.50	1.60	1.70
E1	1.10	1.20	1.30
e	0.50BSC		
L	0.10	0.20	0.30
L1	0.20	0.30	0.40

ZillTek Corp.