

1 外形尺寸 Shape and Dimensions

- 尺寸：见图 1 和表 1
- PCB 焊盘：见图 2 和表 1
- Dimensions: See Fig.1 and Table 1.
- Recommended PCB pattern for reflow soldering: See Fig.2 and Table 1



图 1 Fig.1



图 2 Fig.2

表 1 (Table 1)

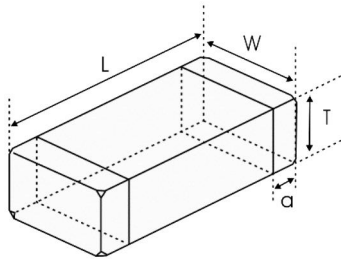
单位 unit: inch[mm]

类别 Type	L	W	T	a	A	B	C
0603 [1608]	0.063±0.006 [1.6±0.15]	0.031±0.006 [0.8±0.15]	0.031±0.006 [0.8±0.15]	0.012±0.008 [0.3±0.2]	[0.6-0.8]	[0.6-0.7]	[0.6-0.8]

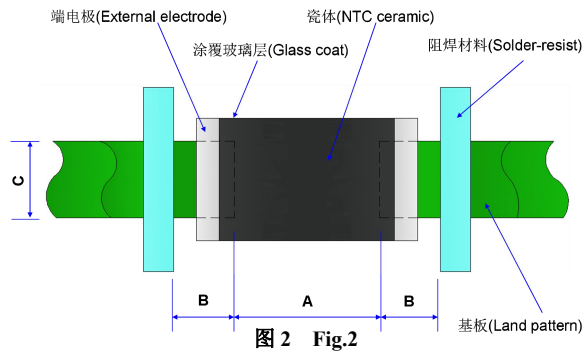
2 电气特性 Electrical Characteristics

型号 Part No	电阻值 Resistance (25°C) (kΩ)	B 常数 B Constant (25/50°C) (K)	B 常数 B Constant (25/85°C) (K)	允许工作电流 Permissible Operating Current (25°C) (mA)	耗散系数 Dissipation Factor (mW/°C)	热时间常数 Thermal Time Constant (s)	额定功率 Rated Electric Power(25°C) (mW)	工作温度 Operating ambient temperature (°C)
KNTC0603/100KJ3950	100±5%	3950±1%	4010	0.10	1.0	<5	100	-40~+125

3 检验和测试程序

测试条件

如无特别规定，检验和测试的标准大气环境条件如下：

- a. 环境温度：20±15℃；
- b. 相对湿度：65±20%；
- c. 气压：86 kPa~106 kPa

如果对测试结果有异议，则在下述条件下测试：

- a. 环境温度：25±2℃；
- b. 相对湿度：65±5%
- c. 气压：86kPa ~ 106kPa

检查设备

外观检查：20 倍放大镜；
阻值检查：热敏电阻测试仪

3 Test and Measurement Procedures

Test Conditions

Unless otherwise specified, the standard atmospheric conditions for measurement/test as:

- a. Ambient Temperature: 20±15℃
- b. Relative Humidity: 65±20%
- c. Air Pressure: 86kPa to 106kPa

If any doubt on the results, measurements/tests should be made within the following limits:

- a. Ambient Temperature: 25±2℃
- b. Relative Humidity: 65±5%
- c. Air Pressure: 86kPa to 106kPa

Inspection Equipment

Visual Examination: 20× magnifier
Resistance value test: Thermistor resistance tester

4 电性测试 Electrical Test

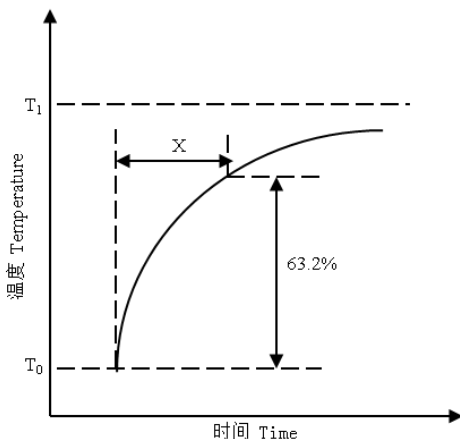
序号 No.	项目 Items	测试方法及备注 Test Methods and Remarks
1	25℃零功率电阻值 Nominal Zero-Power Resistance at 25℃(R25)	环境温度 Ambient temperature: 25±0.05℃ 测试功率 Measuring electric power: ≤0.1mW
2	B 值常数 Nominal B Constant	分别在环境温度 25±0.05℃, 50±0.05℃或 85±0.05℃下测量电阻值。 Measure the resistance at the ambient temperature of 25±0.05℃, 50±0.05℃ or 85±0.05℃. $B(25-50^{\circ}\text{C}) = \frac{\ln R_{25} - \ln R_{50}}{1/T_{25} - 1/T_{50}} \quad B(25-85^{\circ}\text{C}) = \frac{\ln R_{25} - \ln R_{85}}{1/T_{25} - 1/T_{85}}$ T: 绝对温度 (K) Absolute temperature (K)
3	热时间常数 Thermal Time Constant	在零功率条件下，当热敏电阻的环境温度发生急剧变化时，热敏电阻组件产生最初温度 T0 与最终温度 T1 两者温度差的 63.2%的温度变化所需要的时间，通常以秒(S)表示。 The total time for the temperature of the thermistor to change by 63.2% of the difference from ambient temperature T ₀ (°C) to T ₁ (°C) by the drastic change of the power applied to thermistor from Non-zero Power to Zero-Power state, normally expressed in second(S). 

4	耗散系数 Dissipation Factor	在一定环境温度下，NTC 热敏电阻通过自身发热使其温度升高 1℃ 时所需要的功率，通常以 mW/℃ 表示。可由下面公式计算： The required power which makes the NTC thermistor body temperature raise 1℃ through self-heated, normally expressed in milliwatts per degree Celsius (mW/℃). It can be calculated by the following formula: $\delta = \frac{W}{T-T_0}$
5	额定功率 Rated Power	在环境温度 25℃ 下因自身发热使表面温度升高 100℃ 所需要的功率。 The necessary electric power makes thermistor's temperature rise 100℃ by self-heating at ambient temperature 25℃.
6	允许工作电流 Permissible operating current	在静止空气中通过自身发热使其升温为 1℃ 的电流。 The current that keep body temperature of chip NTC on the PC board in still air rising 1℃ by self-heating.

5 信赖性试验 Reliability Test

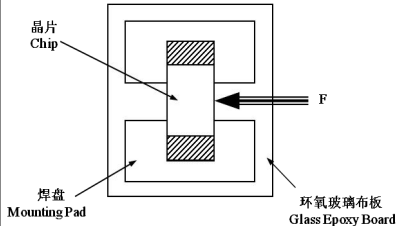
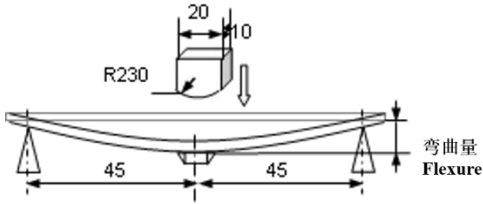
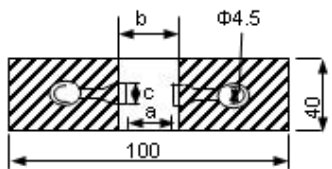
项目 Items	测试标准 Standard	测试方法及备注 Test Methods and Remarks	要求 Requirements																														
端头附着力 Terminal Strength	IEC 60068-2-21	<p>将芯片焊接在测试基板上（如右图所示的环氧玻璃布板），按箭头所示方向施加作用力； Solder the chip to the testing jig (glass epoxy board shown in the right) using eutectic solder. Then apply a force in the direction of the arrow.</p> <table border="1"> <thead> <tr> <th>尺寸 Size</th> <th>F</th> <th>保持时间 Duration</th> </tr> </thead> <tbody> <tr> <td>0201, 0402, 0603</td> <td>5N</td> <td rowspan="2">10±1s</td> </tr> <tr> <td>0805</td> <td>10N</td> </tr> </tbody> </table>	尺寸 Size	F	保持时间 Duration	0201, 0402, 0603	5N	10±1s	0805	10N	<p>端电极无脱落且瓷体无损伤。 No removal or split of the termination or other defects shall occur.</p> 																						
尺寸 Size	F	保持时间 Duration																															
0201, 0402, 0603	5N	10±1s																															
0805	10N																																
抗弯强度 Resistance to Flexure	IEC 60068-2-21	<p>将芯片焊接在测试基板上（如右图所示的环氧玻璃布板），按下图箭头所示方向施加作用力； Solder the chip to the test jig (glass epoxy board shown in the right) using a eutectic solder. Then apply a force in the direction shown as follow;</p>  <table border="1"> <thead> <tr> <th>尺寸 Size</th> <th>弯曲变形量 Flexure</th> <th>施压速度 Pressurizing Speed</th> <th>保持时间 Duration</th> </tr> </thead> <tbody> <tr> <td>0201,</td> <td>1mm</td> <td rowspan="2"><0.5mm/s</td> <td rowspan="2">10±1s</td> </tr> <tr> <td>0402, 0603, 0805</td> <td>2mm</td> </tr> </tbody> </table>	尺寸 Size	弯曲变形量 Flexure	施压速度 Pressurizing Speed	保持时间 Duration	0201,	1mm	<0.5mm/s	10±1s	0402, 0603, 0805	2mm	<p>① 无外观损伤。 No visible damage. ② $\Delta R_{25}/R_{25} \leq 5\%$</p> <p>单位 unit: mm</p> <table border="1"> <thead> <tr> <th>类型 Type</th> <th>a</th> <th>b</th> <th>c</th> </tr> </thead> <tbody> <tr> <td>0201</td> <td>0.25</td> <td>0.3</td> <td>0.3</td> </tr> <tr> <td>0402</td> <td>0.4</td> <td>1.5</td> <td>0.5</td> </tr> <tr> <td>0603</td> <td>1.0</td> <td>3.0</td> <td>1.2</td> </tr> <tr> <td>0805</td> <td>1.2</td> <td>4.0</td> <td>1.65</td> </tr> </tbody> </table> 	类型 Type	a	b	c	0201	0.25	0.3	0.3	0402	0.4	1.5	0.5	0603	1.0	3.0	1.2	0805	1.2	4.0	1.65
尺寸 Size	弯曲变形量 Flexure	施压速度 Pressurizing Speed	保持时间 Duration																														
0201,	1mm	<0.5mm/s	10±1s																														
0402, 0603, 0805	2mm																																
类型 Type	a	b	c																														
0201	0.25	0.3	0.3																														
0402	0.4	1.5	0.5																														
0603	1.0	3.0	1.2																														
0805	1.2	4.0	1.65																														

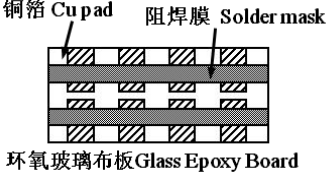
<p>振动 Vibration</p>	<p>IEC 60068-2-80</p>	<p>① 将芯片焊接在测试基板上（如右图所示的环氧玻璃布板）； Solder the chip to the testing jig (glass epoxy board shown in the left) using eutectic solder.</p> <p>② 芯片以全振幅为 1.5mm 进行振动，频率范围为 10Hz ~55 Hz； The chip shall be subjected to a simple harmonic motion having total amplitude of 1.5mm, the frequency being varied uniformly between the approximate limits of 10 and 55 Hz.</p> <p>③ 振动频率按 10Hz→55Hz→10Hz 循环，周期为 1 分钟，在空间三个互相垂直的方向上各振动 2 小时（共 6 小时）。 The frequency ranges from 10 to 55 Hz and return to 10 Hz shall be traversed in approximately 1 minute. This motion shall be applied for a period of 2 hours in each 3 mutually perpendicular directions (total of 6 hours).</p>	<p>无外观损伤。 No visible damage.</p> 															
<p>坠落 Dropping</p>	<p>IEC 60068-2-32</p>	<p>从 1m 的高度让芯片自由坠落至水泥地面 10 次。 Drop a chip 10 times on a concrete floor from a height of 1 meter.</p>	<p>无外观损伤。 No visible damage.</p>															
<p>可焊性 Solderability</p>	<p>IEC 60068-2-58</p>	<p>① 焊接温度 Solder temperature: 245±5℃. ② 浸渍时间 Duration: 3±0.3s. ③ 焊锡成分 Solder: Sn/3.0Ag/0.5Cu. ④ 助焊剂 Flux: （重量比）25%松香和 75%酒精 25% Resin and 75% ethanol in weight.</p>	<p>① 无外观损伤； No visible damage. ② 组件端电极的焊锡覆盖率不小于 95%。 Wetting shall exceed 95% coverage.</p>															
<p>耐焊性 Resistance to Soldering Heat</p>	<p>IEC 60068-2-58</p>	<p>① 焊接温度 Solder temperature: 260±5℃. ② 浸渍时间 Duration: 10±1s. ③ 焊锡成分 Solder: Sn/3.0Ag/0.5Cu. ④ 助焊剂 Flux: （重量比）25%松香和 75%酒精 25% Resin and 75% ethanol in weight. ⑤ 试验后标准条件下放置 1~2 小时后测量。 The chip shall be stabilized at normal condition for 1~2 hours before measuring.</p>	<p>① 无外观损伤； No visible damage. ② $\Delta R_{25}/R_{25} \leq 5\%$ ③ $\Delta B/B \leq 2\%$</p>															
<p>温度周期 Temperature cycling</p>	<p>IEC 60068-2-14</p>	<p>① 无负载于下表所示的环境条件下重复 5 次。 5 cycles of following sequence without loading.</p> <table border="1" data-bbox="491 1429 1040 1624"> <thead> <tr> <th>步骤 Step</th> <th>温度 Temperature</th> <th>时间 Time</th> </tr> </thead> <tbody> <tr> <td>1</td> <td>-40±5℃</td> <td>30±3min</td> </tr> <tr> <td>2</td> <td>25±2℃</td> <td>5±3min</td> </tr> <tr> <td>3</td> <td>125±2℃</td> <td>30±3min</td> </tr> <tr> <td>4</td> <td>25±2℃</td> <td>5±3min</td> </tr> </tbody> </table> <p>② 试验后标准条件下放置 1~2 小时后测量。 The chip shall be stabilized at normal condition for 1~2 hours before measuring.</p>	步骤 Step	温度 Temperature	时间 Time	1	-40±5℃	30±3min	2	25±2℃	5±3min	3	125±2℃	30±3min	4	25±2℃	5±3min	<p>① 无外观损伤； No visible damage. ② $\Delta R_{25}/R_{25} \leq 3\%$ ③ $\Delta B/B \leq 2\%$</p>
步骤 Step	温度 Temperature	时间 Time																
1	-40±5℃	30±3min																
2	25±2℃	5±3min																
3	125±2℃	30±3min																
4	25±2℃	5±3min																
<p>高温存放 Resistance to dry heat</p>	<p>IEC 60068-2-2</p>	<p>① 在 125±5℃ 空气中，无负载放置 1000±24 小时。 125±5℃ in air, for 1000±24 hours without loading. ② 试验后标准条件下放置 1~2 小时后测量。 The chip shall be stabilized at normal condition for 1~2 hours before measuring.</p>	<p>① 无外观损伤； No visible damage. ② $\Delta R_{25}/R_{25} \leq 5\%$ ③ $\Delta B/B \leq 2\%$</p>															

低温存放 Resistance to cold	IEC 60068-2-1	① 在-40±3℃空气中，无负载放置 1000±24 小时。 -40±3℃ in air, for 1000±24 hours without loading. ② 试验后标准条件下放置 1~2 小时后测量。 The chip shall be stabilized at normal condition for 1~2 hours before measuring.	① 无外观损伤； No visible damage. ② $ \Delta R25/R25 \leq 5\%$ ③ $ \Delta B/B \leq 2\%$
湿热存放 Resistance to damp heat	IEC 60068-2-78	① 在 40±2℃，相对湿度 90~95%空气中，无负载放置 1000±24 小时。 40±2℃, 90~95%RH in air, for 1000±24 hours without loading. ② 试验后标准条件下放置 1~2 小时后测量。 The chip shall be stabilized at normal condition for 1~2 hours before measuring.	① 无外观损伤； No visible damage. ② $ \Delta R25/R25 \leq 3\%$ ③ $ \Delta B/B \leq 2\%$
高温负荷 Resistance to high temperature load	IEC 60539-1 5.25.4	① 在 85±2℃空气中，施加允许工作电流 1000±48 小时。 85±2℃ in air with permissive operating current for 1000±48 hours ② 试验后标准条件下放置 1~2 小时后测量。 The chip shall be stabilized at normal condition for 1~2 hours before measuring.	① 无外观损伤； No visible damage. ② $ \Delta R25/R25 \leq 5\%$ ③ $ \Delta B/B \leq 2\%$

6 编带 Taping

类型 Type	0201	0402	0603	0805
编带厚度 Tape thickness(mm)	0.5±0.15	0.5±0.15	0.8±0.15	0.85±0.2
编带材质 Tape material	纸带 Paper Tape			
每盘数量 Quantity per Reel	15K	10K	4K	4K

(1) 编带图 Taping Drawings

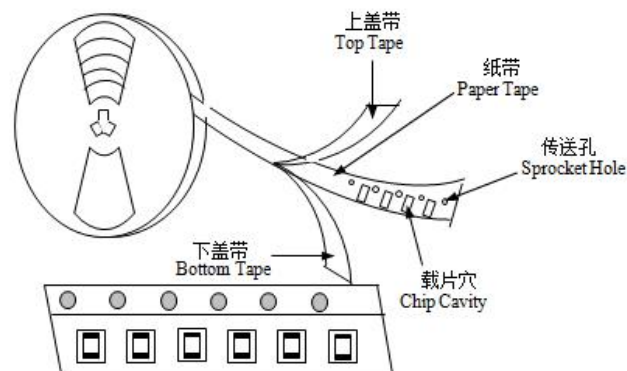

(2) 纸带尺寸 Paper Tape Dimensions

(单位 Unit: mm)

0201 系列

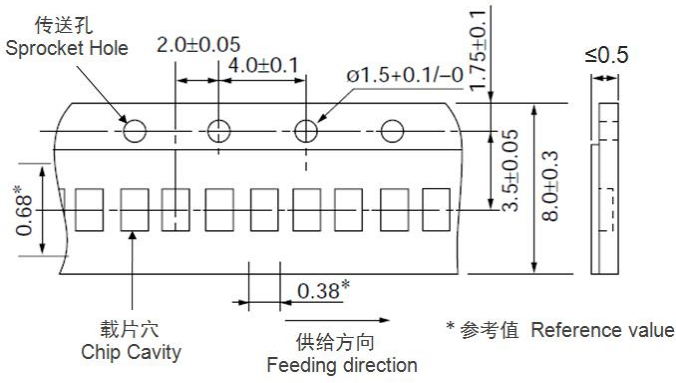

0402 系列

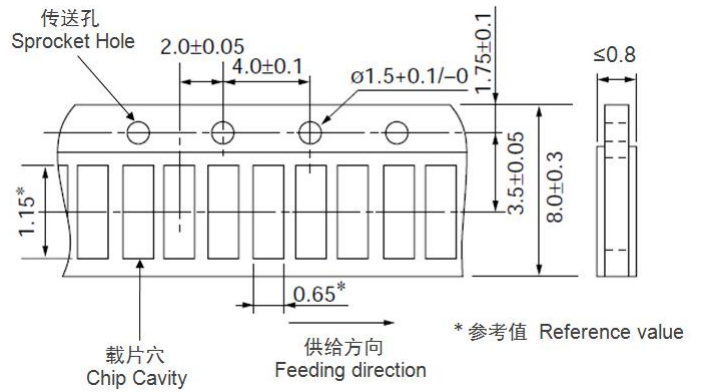

0603 系列

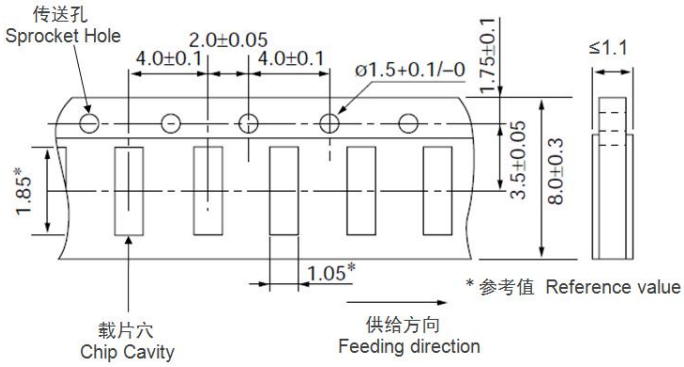

0805 系列

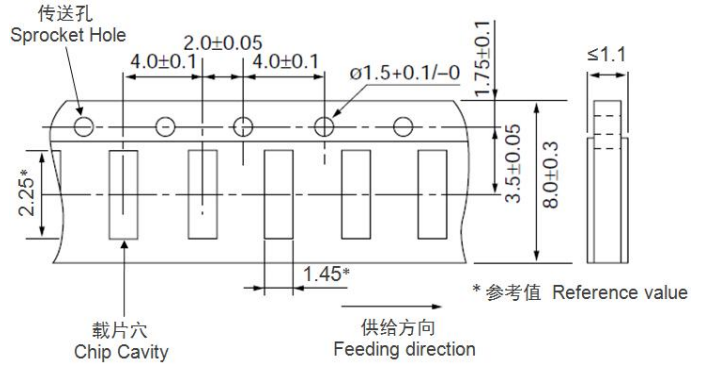

(3) 卷盘尺寸 Reel Dimensions (单位 Unit: mm)

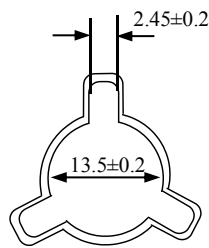
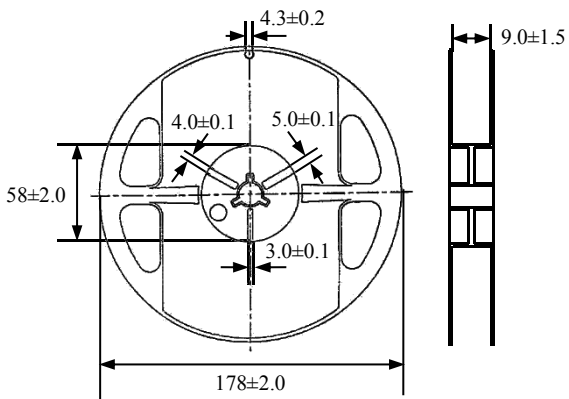

7 储存

- **储存条件**
 - a. 储存温度: $-10^{\circ}\text{C} \sim 40^{\circ}\text{C}$
 - b. 相对湿度: $\leq 75\%RH$
 - c. 避免接触粉尘、腐蚀性气氛和阳光
- **储存期限: 产品交付后 6 个月**

8 注意事项

- 热敏电阻不可在以下条件下工作或储存:
 - (1) 腐蚀性气体或还原性气体
(氯气、硫化氢气体、氨气、硫酸气体、一氧化氮等)。
 - (2) 挥发性或易燃性气体
 - (3) 多尘条件
 - (4) 高压或低压条件
 - (5) 潮湿场所
 - (6) 存在盐水、油、化学液体或有机溶剂的场所
 - (7) 强烈振动
 - (8) 存在类似有害条件的其他场所
- 热敏电阻的陶瓷属于易碎材料, 使用时不可施加过大压力或冲击。
- 热敏电阻不可在超过目录规定的温度范围情况下工作。

7 Storage

- **Storage Conditions**
 - a. Storage Temperature: $-10^{\circ}\text{C} \sim 40^{\circ}\text{C}$
 - b. Relative Humidity: $\leq 75\%RH$
 - c. Keep away from corrosive atmosphere and sunlight.
- **Period of Storage: 6 Months after delivery**

8 Notes & Warnings

- The thermistors shall not be operated and stored under the following environmental condition:
 - (1) Corrosive or deoxidized atmospheres
(such as chlorine, sulfurated hydrogen, ammonia, sulfuric acid, nitric oxide and so on)
 - (2) Volatile or inflammable atmospheres
 - (3) Dusty condition
 - (4) Excessively high or low pressure condition
 - (5) Humid site
 - (6) Places with brine, oil, chemical liquid or organic solvent
 - (7) Intense vibration
 - (8) Places with analogously deleterious conditions
- The ceramic body of the thermistors is fragile, no excessive pressure or impact shall be exerted on it.
- The thermistors shall not be operated beyond the specified "Operating Temperature Range" in the catalog.

9 建议焊接条件

• 回流焊

温升 1~2°C/sec.

预热：150~170°C/90±30 sec.

大于 240°C 时间：20~40sec

峰值温度：最高 260°C/10 sec.

焊锡：96.5Sn/3.0Ag/0.5Cu

回流焊：最多 2 次

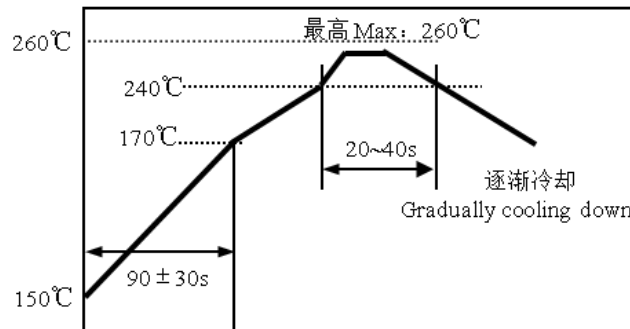

9 Recommended Soldering Technologies

• Re-flowing Profile

1~2°C/sec. Ramp

Pre-heating: 150~170°C/90±30 sec.

Time above 240°C: 20~40 sec.

Peak temperature: 260°C Max./10 sec.

Solder paste: 96.5Sn/3.0Ag/0.5Cu

Max.2 times for re-flowing

• 手工焊

烙铁功率：最大 20W

预热：150°C/60sec.

烙铁头温度：最高 280°C

焊接时间：最多 3sec.

焊锡：96.5Sn/3.0Ag/0.5Cu

手工焊：最多 1 次

• Iron Soldering Profile

Iron soldering power: Max.20W

Pre-heating: 150°C/60sec.

Soldering Tip temperature: 280°C Max.

Soldering time: 3 sec Max.

Solder paste: 96.5Sn/3.0Ag/0.5Cu

Max.1 times for iron soldering

[注：不要使烙铁头接触到端头]

[Note: Take care not to apply the tip of the soldering iron to the terminal electrodes.]

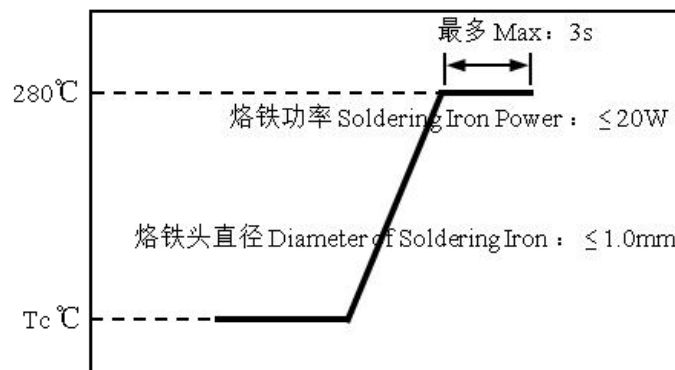

10 R-T 表 R-T table

温度 Temp. (°C)	R 最小值 R_Min (Kohm)	R 中心值 R_Cent (Kohm)	R 最大值 R_Max (Kohm)	阻值公差 Res TOL.	温度公差 Temp. TOL.(°C)
-40	2,959.652	3,225.545	3,506.537	8.71%	1.27
-39	2,775.905	3,023.332	3,284.581	8.64%	1.27
-38	2,604.649	2,834.987	3,077.980	8.57%	1.27
-37	2,444.966	2,659.483	2,885.589	8.50%	1.27
-36	2,296.011	2,495.874	2,706.351	8.43%	1.27
-35	2,157.005	2,343.289	2,539.296	8.36%	1.27
-34	2,027.228	2,200.924	2,383.529	8.30%	1.27
-33	1,906.018	2,068.041	2,238.226	8.23%	1.27
-32	1,792.763	1,943.955	2,102.627	8.16%	1.27
-31	1,686.897	1,828.036	1,976.032	8.10%	1.27
-30	1,587.898	1,719.704	1,857.794	8.03%	1.27
-29	1,495.284	1,618.419	1,747.315	7.96%	1.26
-28	1,408.608	1,523.686	1,644.045	7.90%	1.26
-27	1,327.458	1,435.046	1,547.475	7.83%	1.26
-26	1,251.451	1,352.073	1,457.134	7.77%	1.26
-25	1,180.234	1,274.376	1,372.587	7.71%	1.26
-24	1,113.480	1,201.590	1,293.431	7.64%	1.26
-23	1,050.884	1,133.379	1,219.293	7.58%	1.26
-22	992.166	1,069.430	1,149.829	7.52%	1.26
-21	937.065	1,009.455	1,084.719	7.46%	1.25
-20	885.338	953.185	1,023.666	7.39%	1.25
-19	836.762	900.373	966.398	7.33%	1.25
-18	791.127	850.787	912.658	7.27%	1.25
-17	748.240	804.212	862.211	7.21%	1.25
-16	707.920	760.451	814.838	7.15%	1.25
-15	670.002	719.319	770.336	7.09%	1.24
-14	634.328	680.643	728.514	7.03%	1.24
-13	600.755	644.265	689.199	6.97%	1.24
-12	569.147	610.035	652.225	6.92%	1.24
-11	539.380	577.816	617.442	6.86%	1.24
-10	511.337	547.478	584.709	6.80%	1.24
-9	484.908	518.903	553.894	6.74%	1.23
-8	459.992	491.979	524.874	6.69%	1.23
-7	436.496	466.601	497.536	6.63%	1.23
-6	414.330	442.674	471.774	6.57%	1.23
-5	393.413	420.105	447.488	6.52%	1.23
-4	373.667	398.813	424.586	6.46%	1.22
-3	355.022	378.717	402.983	6.41%	1.22
-2	337.409	359.744	382.598	6.35%	1.22
-1	320.768	341.826	363.356	6.30%	1.22
0	305.038	324.899	345.187	6.24%	1.21
1	290.166	308.903	328.027	6.19%	1.21

温度 Temp. (°C)	R 最小值 R_Min (Kohm)	R 中心值 R_Cent (Kohm)	R 最大值 R_Max (Kohm)	阻值公差 Res TOL.	温度公差 Temp. TOL.(°C)
2	276.101	293.781	311.813	6.14%	1.21
3	262.794	279.483	296.488	6.08%	1.21
4	250.200	265.958	282.000	6.03%	1.20
5	238.279	253.161	268.299	5.98%	1.20
6	226.990	241.049	255.338	5.93%	1.20
7	216.298	229.582	243.073	5.88%	1.20
8	206.166	218.722	231.463	5.82%	1.19
9	196.564	208.435	220.470	5.77%	1.19
10	187.461	198.687	210.058	5.72%	1.19
11	178.828	189.447	200.194	5.67%	1.18
12	170.639	180.686	190.846	5.62%	1.18
13	162.869	172.377	181.984	5.57%	1.18
14	155.494	164.495	173.581	5.52%	1.18
15	148.492	157.015	165.611	5.47%	1.17
16	141.843	149.914	158.049	5.43%	1.17
17	135.527	143.173	150.872	5.38%	1.17
18	129.525	136.770	144.059	5.33%	1.16
19	123.821	130.688	137.590	5.28%	1.16
20	118.399	124.908	131.445	5.23%	1.16
21	113.242	119.413	125.607	5.19%	1.15
22	108.337	114.190	120.059	5.14%	1.15
23	103.670	109.222	114.785	5.09%	1.15
24	99.228	104.497	109.770	5.05%	1.14
25	95.000	100.000	105.000	5.00%	1.14
26	90.895	95.720	100.550	5.05%	1.16
27	86.988	91.646	96.312	5.09%	1.18
28	83.269	87.766	92.275	5.14%	1.19
29	79.729	84.071	88.428	5.18%	1.21
30	76.357	80.550	84.761	5.23%	1.23
31	73.145	77.195	81.265	5.27%	1.25
32	70.085	73.997	77.931	5.32%	1.26
33	67.169	70.947	74.751	5.36%	1.28
34	64.389	68.039	71.717	5.41%	1.30
35	61.738	65.265	68.821	5.45%	1.32
36	59.210	62.618	66.058	5.49%	1.34
37	56.798	60.092	63.419	5.54%	1.36
38	54.496	57.681	60.899	5.58%	1.38
39	52.300	55.379	58.492	5.62%	1.39
40	50.203	53.180	56.193	5.67%	1.41
41	48.201	51.080	53.995	5.71%	1.43
42	46.288	49.073	51.894	5.75%	1.45
43	44.462	47.155	49.886	5.79%	1.47
44	42.716	45.321	47.966	5.83%	1.49
45	41.048	43.569	46.129	5.88%	1.51

温度 Temp. (°C)	R 最小值 R_Min (Kohm)	R 中心值 R_Cent (Kohm)	R 最大值 R_Max (Kohm)	阻值公差 Res TOL.	温度公差 Temp. TOL.(°C)
46	39.453	41.892	44.371	5.92%	1.53
47	37.928	40.289	42.689	5.96%	1.55
48	36.469	38.755	41.080	6.00%	1.57
49	35.074	37.286	39.539	6.04%	1.59
50	33.739	35.881	38.063	6.08%	1.61
51	32.462	34.536	36.650	6.12%	1.63
52	31.239	33.248	35.296	6.16%	1.65
53	30.069	32.014	33.999	6.20%	1.67
54	28.947	30.832	32.756	6.24%	1.69
55	27.874	29.699	31.565	6.28%	1.71
56	26.845	28.614	30.423	6.32%	1.73
57	25.859	27.573	29.327	6.36%	1.75
58	24.914	26.576	28.277	6.40%	1.77
59	24.009	25.619	27.269	6.44%	1.79
60	23.140	24.701	26.302	6.48%	1.81
61	22.308	23.821	25.374	6.52%	1.83
62	21.509	22.976	24.483	6.56%	1.85
63	20.743	22.166	23.627	6.59%	1.88
64	20.007	21.388	22.806	6.63%	1.90
65	19.302	20.641	22.017	6.67%	1.92
66	18.624	19.923	21.260	6.71%	1.94
67	17.974	19.234	20.532	6.75%	1.96
68	17.349	18.572	19.832	6.78%	1.98
69	16.749	17.936	19.159	6.82%	2.00
70	16.173	17.325	18.513	6.86%	2.03
71	15.619	16.738	17.891	6.89%	2.05
72	15.087	16.173	17.294	6.93%	2.07
73	14.575	15.630	16.719	6.97%	2.09
74	14.083	15.108	16.166	7.00%	2.11
75	13.611	14.605	15.633	7.04%	2.14
76	13.156	14.122	15.121	7.08%	2.16
77	12.718	13.657	14.628	7.11%	2.18
78	12.297	13.209	14.154	7.15%	2.20
79	11.892	12.779	13.696	7.18%	2.23
80	11.503	12.364	13.256	7.22%	2.25
81	11.128	11.965	12.832	7.25%	2.27
82	10.766	11.580	12.424	7.29%	2.30
83	10.419	11.210	12.030	7.32%	2.32
84	10.084	10.853	11.651	7.36%	2.34
85	9.761	10.509	11.286	7.39%	2.36
86	9.450	10.177	10.933	7.43%	2.39
87	9.151	9.858	10.593	7.46%	2.41
88	8.862	9.550	10.266	7.50%	2.44
89	8.584	9.253	9.950	7.53%	2.46

温度 Temp. (°C)	R 最小值 R_Min (Kohm)	R 中心值 R_Cent (Kohm)	R 最大值 R_Max (Kohm)	阻值公差 Res TOL.	温度公差 Temp. TOL.(°C)
90	8.315	8.967	9.645	7.56%	2.48
91	8.057	8.691	9.351	7.60%	2.51
92	7.807	8.424	9.067	7.63%	2.53
93	7.567	8.167	8.793	7.66%	2.55
94	7.335	7.919	8.529	7.70%	2.58
95	7.111	7.680	8.273	7.73%	2.60
96	6.895	7.449	8.027	7.76%	2.63
97	6.686	7.226	7.789	7.80%	2.65
98	6.485	7.010	7.559	7.83%	2.68
99	6.291	6.802	7.337	7.86%	2.70
100	6.103	6.601	7.122	7.89%	2.73
101	5.922	6.407	6.915	7.93%	2.75
102	5.747	6.220	6.715	7.96%	2.78
103	5.578	6.039	6.521	7.99%	2.80
104	5.415	5.864	6.334	8.02%	2.83
105	5.257	5.694	6.153	8.05%	2.85
106	5.104	5.531	5.978	8.08%	2.88
107	4.957	5.373	5.809	8.12%	2.90
108	4.814	5.220	5.645	8.15%	2.93
109	4.677	5.072	5.486	8.18%	2.95
110	4.543	4.929	5.333	8.21%	2.98
111	4.414	4.790	5.185	8.24%	3.00
112	4.290	4.656	5.041	8.27%	3.03
113	4.169	4.527	4.902	8.30%	3.06
114	4.052	4.401	4.768	8.33%	3.08
115	3.940	4.280	4.638	8.36%	3.11
116	3.830	4.162	4.511	8.39%	3.14
117	3.725	4.048	4.389	8.42%	3.16
118	3.622	3.938	4.271	8.45%	3.19
119	3.523	3.831	4.156	8.48%	3.21
120	3.427	3.728	4.045	8.51%	3.24
121	3.334	3.628	3.938	8.54%	3.27
122	3.244	3.531	3.834	8.57%	3.30
123	3.157	3.437	3.732	8.60%	3.32
124	3.072	3.346	3.634	8.63%	3.35
125	2.990	3.257	3.539	8.66%	3.38