



深圳市凯越翔实业

石英谐振器规格书

产品名称:	石英晶体谐振器
产品型号:	49USSMD/27.000MHZ
产品参数:	20PF/±20ppm
原厂型号:	KBD270002020
尺寸图:	P. 4
凯越翔实业技术部:	董宗全

客 户 确 认 栏

认证印章	负责人印章
年 月 日	年 月 日

本规格章程连同本页共 5 页

产品规格书

1.GENERAL	
1.1 HOLDER TYPE	49USSMD
1.2 MODE OF VIBRATION	AT CUT
1.3 OSCILLATION MODE	FUND
1.4 TEST FACILITIES	S&A KH-1240
1.5 STORAGE TEMPERATURE	-40℃ TO +85℃
1.6 DRIVER LEVEL	100 μ W
2.ELECTRICAL PARAMETER	
2.1 NORMAL FREQUENCY	27.000MHz
2.2 FREQUENCY TOLERANCE (25℃ ±2℃)	±20ppm
2.3 TEMPERATURE STABILITY	±20ppm
2.4 OPERATING TEMPERATURE RANGE	-20℃ TO + 70℃
2.5 LOAD CAPACITANCE	20PF
2.6 MOTIONAL CAPACITANCE	
2.7 SHUNT CAPACITANCE	7PF MAX
2.8 EFFECTIVE SERIES RESISTANCE	40 Ω MAX
2.9 INSULATION RESISTANCE	500M OHMS MIN AT DC 100V
3.MECHANICAL PARAMETER	
3.1 SOLDERABILITY	95%COVERAGE BY USING 90/10 SOLD AT 245℃ FOR 5 SEC. DIPPING AFTER IMMERSION IN ALPHA 611 FLUX FOR 5 SEC.

I MECHANICAL ENDURANCE 机械特性

Provided that measurement shall be carried out after letting it alone in the room temperature for 1 hour.

试验产品应在室温下放置 1 小时后方可进行以下试验。

① SHOCK 抗击测试

Electrical characteristics shall be satisfied after dropping three time from the height of 50 cm onto Hard wooden board .

产品从 50 cm 高度自由落下到硬木板 3 次电气参数仍符合要求。

② VIBRATION 抗振测试

Electrical characteristics shall be satisfied after supplying following Vibration .

电气性能应满足以下的振动要求。

- | | | | |
|--------------|-----------|-------|---------------------------------|
| (1)VIBRATION | FREQUENCY | 振动频率 | 10—55Hz |
| (2)REPEATED | PERIOD | 周 期 | 1—2min |
| (3)FULL | CYCLE | 全 振 幅 | 1.5mm P—P |
| (4)DIRECTION | | 振动方向 | X.Y.Z |
| (5)TIME | | 振动时间 | 2hours/each direction 2 小时/每个方向 |

③ STRENGTH OF TERMINALS/LEAD—WIRES 引脚与基座底部的强度测试

-1 PULLING 拉力测试

a)Body of specimen shall be fixed, and 900g of tension weight shall be supplied gradually to axial direction of terminals/lead-wires for 30 sec .

产品应固定在 900g 的拉力的情况下逐渐延基座底部/引线脚中轴方向拉 30 秒钟。

b)After above test a), there is no observation of any visual damages on the specimen.

经过 a)的测试, 产品应没有任何可以目测到的损坏。

-2 BENDING 弯曲度测试

a)Body of specimen shall be fixed, and 90degree bending shall be given, being supplied 225gs tension weight .

After that, terminals/lead-wires shall be straightened gradually .

Then the same bending and straightening shall be supplied to the opposite direction in the same axial . (Refer to Fig-1)

产品固定后, 以 90° 的弯曲并供以 225g 的拉力, 然后沿同一轴线并与相反的方向 90° 的弯曲及伸直。(产品结构如图 1 所示)

b)After above test a), there is no observation of any visual damages on the specimen .

通过 a)测试后, 晶体上应没有任何可以目测到的损坏。

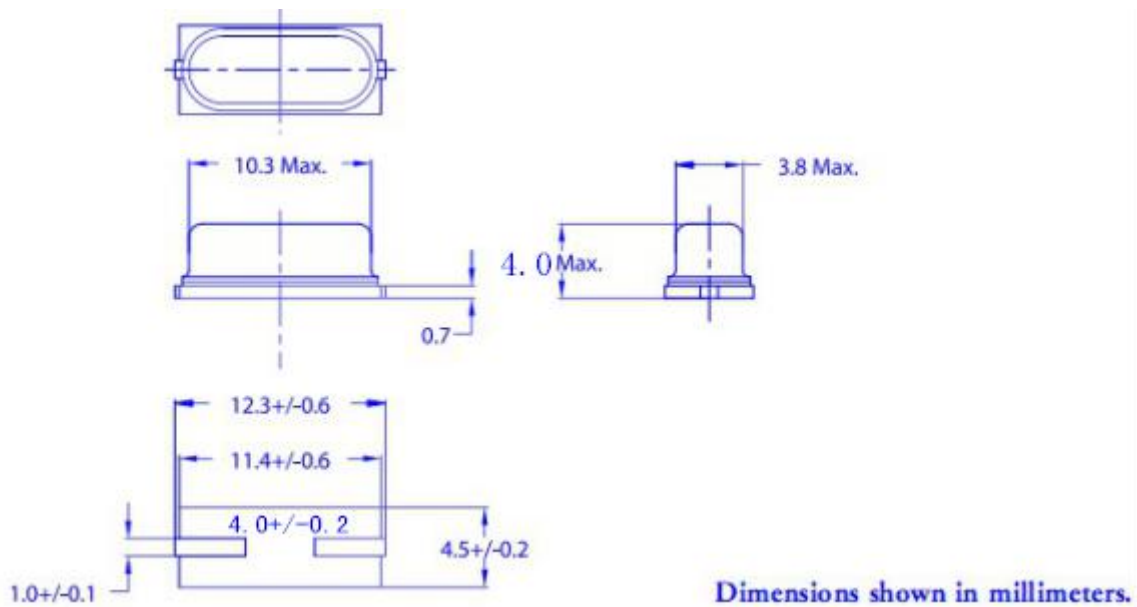

④ SEALING TIGHTNESS 气密性测试

There is no observation of gas bubble after specimen put in hot water at +90°C—+95°C for 5 min .

晶体置于+90°C—+95°C的热水中 5 分钟，应没有气泡产生。

⑤ SOLDERING DIP 浸锡测试

Terminals/lead-wires of specimen shall be dipped into solder melted tank at +230°C—±5°C for 3sec . Dipping depth shall be 2mm from the bottom of specimens body . (After applying ROSIN flux) Soldering portion shall be covered in over 90% of terminals/lead-wires dipped .

将晶体引线脚置于+230°C—±5°C的锡桶中 3 分钟，基座底部离锡表面 2mm，（加上松香焊剂后）引线脚的沾锡率为 90%以上。

⑥ SOLDER HEATING 沾锡耐热性测试

Terminals/lead-wires of specimen shall be dipped into solder melted tank at

+350°C—±10°C for $\frac{1}{3}$ ₋₀ sec .

Electrical characteristics shall be satisfied after dipping depth shall be 2mm from edge of terminals/lead-wires .

将已沾锡的产品的引线脚置于+350°C—±10°C的锡桶中 3-4 秒钟后 基座底部离锡表面 2mm，电气性能仍符合要求。

II ENVIRONMENTAL ENDURANCE 环境特性

Provided that measurement shall be carried out after letting it alone in the room temperature for 1 hour .

必须将试验产品在室温下放置 1 小时后方可进行测试。

① HUMIDITY 耐湿测试

Electrical characteristics shall be satisfied after letting it alone at 60°C—±2°C in humidity of 90—95% for 250 hours .

试验产品在温度为 60°C—±2°C，相对湿度 90—95%的试验箱内放置 250 小时后电气性能仍符合要求。

② STORAGE IN LOW TEMPERATURE 低温储存测试

Electrical characteristics shall be satisfied after letting it alone at -30°C—±2°C for 250 hours .

试验产品在温度为-30°C—±2°C的试验箱中放置 250 小时后电气性能仍符合要求。

③ STORAGE IN HIGH TEMPERATURE 高温储存测试

Electrical characteristics shall be satisfied after letting it alone at +85°C—±2°C for 250 hours .

试验产品在温度为+85°C—±2°C的试验箱中放置 250 小时后电气性能仍符合要求。

④ TEMPERATURE CYCLE 温度变换测试

Electrical characteristics shall be satisfied after supplying the following temperature cycle (3cycles) .

Temperature shift from low to high, high to low shall be done in 1°C/min (Refer to Fig-2) .

电气性能应满足以下温度周期要求（3 个周期）

温度变换从低到高，从高到低变化量为 1°C/分。（如图 2 所示）



PIG — 2

拟 制	成望生	审 核	董宗全	批 准	赵庸桓
-----	-----	-----	-----	-----	-----