

Isolation Fly-back Converter PWM method
Output 24W 12V
BM2P10B1J-EVK-001

<High Voltage Safety Precautions>

◇ Read all safety precautions before use

Please note that this document covers only the **BM2P10B1J** evaluation board (BM2P10B1J-EVK-001) and its functions. For additional information, please refer to the datasheet.

To ensure safe operation, please carefully read all precautions before handling the evaluation board



Depending on the configuration of the board and voltages used,

Potentially lethal voltages may be generated.

Therefore, please make sure to read and observe all safety precautions described in the red box below.

Before Use

- [1] Verify that the parts/components are not damaged or missing (i.e. due to the drops).
- [2] Check that there are no conductive foreign objects on the board.
- [3] Be careful when performing soldering on the module and/or evaluation board to ensure that solder splash does not occur.
- [4] Check that there is no condensation or water droplets on the circuit board.

During Use

- [5] Be careful to not allow conductive objects to come into contact with the board.
- [6] **Brief accidental contact or even bringing your hand close to the board may result in discharge and lead to severe injury or death.**

Therefore, DO NOT touch the board with your bare hands or bring them too close to the board.

In addition, as mentioned above please exercise extreme caution when using conductive tools such as tweezers and screwdrivers.

- [7] If used under conditions beyond its rated voltage, it may cause defects such as short-circuit or, depending on the circumstances, explosion or other permanent damages.
- [8] Be sure to wear insulated gloves when handling is required during operation.

After Use

- [9] The ROHM Evaluation Board contains the circuits which store the high voltage. Since it stores the charges even after the connected power circuits are cut, please discharge the electricity after using it, and please deal with it after confirming such electric discharge.
- [10] Protect against electric shocks by wearing insulated gloves when handling.

This evaluation board is intended for use only in research and development facilities and should be handled **only by qualified personnel familiar with all safety and operating procedures.**

We recommend carrying out operation in a safe environment that includes the use of high voltage signage at all entrances, safety interlocks, and protective glasses.

AC/DC Converter

Flyback Type PWM Mode Isolated 12 V 2.0 A 24 W BM2P10B1J Evaluation Board

BM2P10B1J-EVK-001

General Description

This evaluation board outputs an isolated voltage of 12 V from an input of 90 Vac to 264 Vac, and the maximum output current is 2.0 A.

BM2P10B1J-Z which is PWM method DC/DC converter IC built-in 730 V MOSFET is used.

Built-in the low on resistor (1.0 Ω) and high voltage tolerant MOSFET (730 V) make designs easy.

PWM controller for AC / DC power supplies, the BM2P10B1J provides the optimum system for all products with outlets.



Figure 1. BM2P10B1J-EVK-001

Performance Specification

Not guarantee the characteristics is representative value.

Unless otherwise specified $V_{IN} = 230 \text{ Vac}$, $I_{OUT} = 2.0 \text{ A}$, $T_a = 25 \text{ }^\circ\text{C}$

Parameter	Symbol	Min	Typ	Max	Units	Conditions
Input Voltage Range	V_{IN}	90	230	264	V	
Input Frequency	f_{LINE}	47	50/60	63	Hz	
Output Voltage	V_{OUT}	11.64	12.0	12.36	V	
Output Current Range ^(Note 1)	I_{OUT}	0	-	2	A	
Maximum Output Power	P_{OUT}	-	-	24	W	$I_{OUT} = 2\text{A}$
Standby Input Power	P_{INSTBY}	-	80	-	mW	$I_{OUT} = 0 \text{ A}$
Power supply efficiency	η	-	86.5	-	%	
Output Ripple Voltage ^(Note 1)	V_{RIPPLE}	-	0.13	0.24	Vpp	BW=20MHz
Operating Temperature	T_{op}	-10	+25	+65	$^\circ\text{C}$	

(Note 1) Not include spikes noise.

Derating

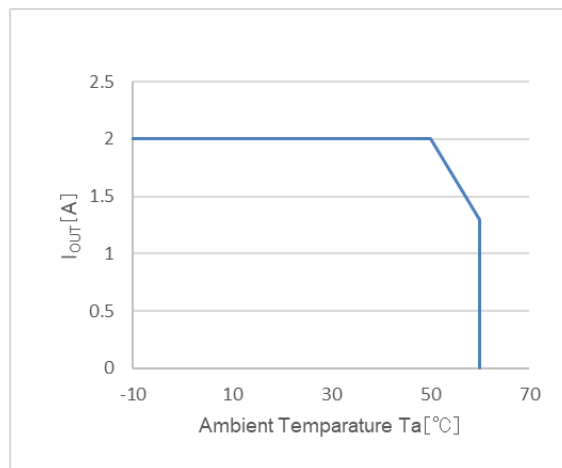

Figure 2. Temperature derating curve

Operation Procedure

1. Operation Equipment

- (1) AC power supply (90 Vac to 264 Vac, 100 W or more)
- (2) Load equipment (2 A at maximum value)
- (3) DC voltmeter

2. Connect method

- (1) Preset the AC power to 90 Vac to 264 Vac and turn off the power output.
- (2) Set the load below the rated current of each output to disable the load.
- (3) Connect the N pin of the power supply to the CN1-1: AC (N) pin and the L pin to the CN1-2: AC (L) pin with a pair of wires.
- (4) Connect each load to VOUT pin from the positive pin and to GND pin from the negative pin with a pair of wires.
- (5) When connecting a power meter, connect as follows. (For details, refer to the User's Manual of the electricity meter you are using.)
- (6) Connect the positive pin of the DC voltmeter to VOUT pin and the negative pin to GND pin for output voltage measurement.
- (7) AC power supply switch is ON.
- (8) Make sure that the DC voltmeter reading is at the set voltage (12 V).
- (9) Electronic load switch is ON.

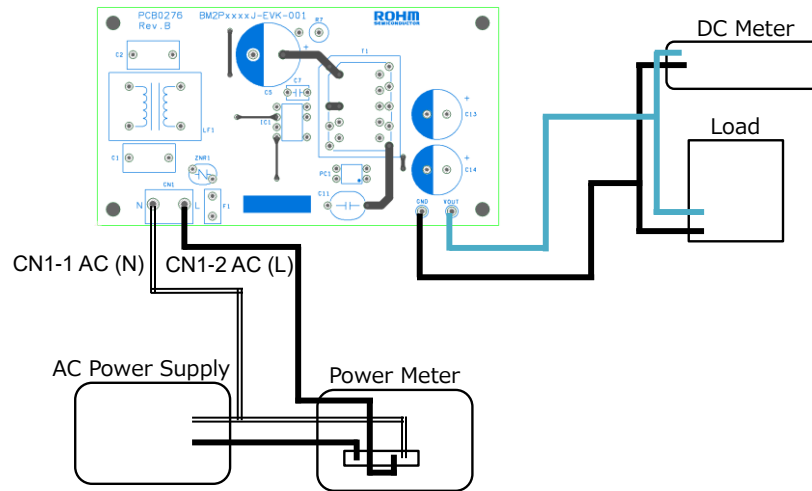

Figure 3. Diagram of How to Connect

Application Circuit

This evaluation board operates in flyback mode at a maximum frequency of around 100 kHz.

The output (12 V) voltage is monitored by a feedback circuit and feed back to the FB pin of BM2P10B1J through an opto-coupler.

At startup, the voltage at the VCC pin rises as the voltage is supplied from the DRAIN pin to the VCC pin through the start circuit.

The demo board schematic is shown in Figure below and the list of parts is tabulated on page 13.

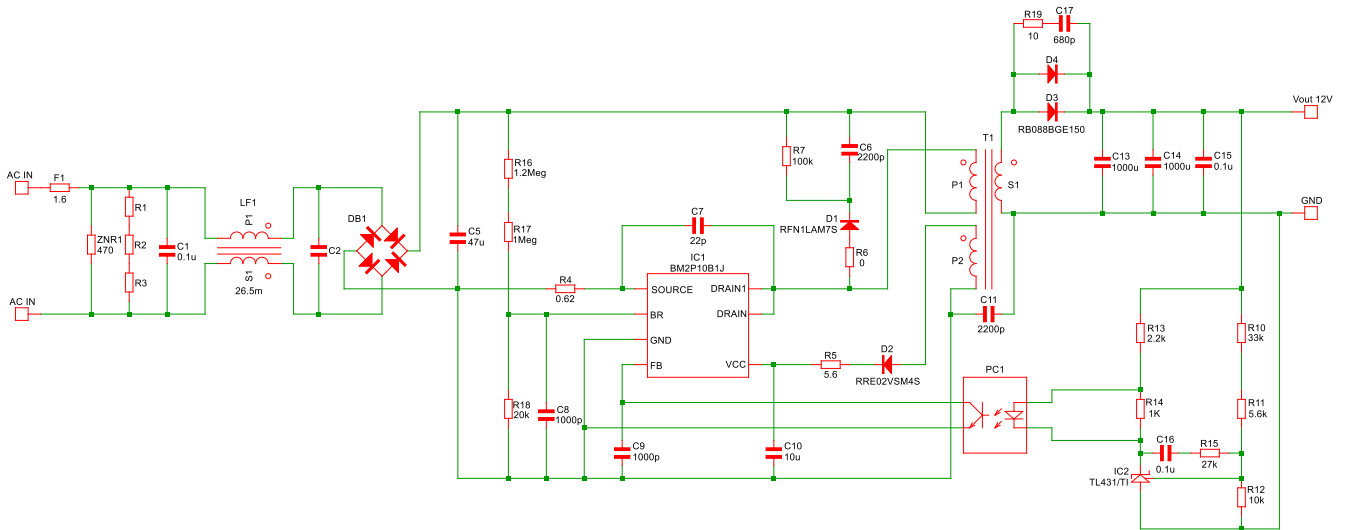

BM2P10B1J General Description

Features

- PWM Current Mode
- Frequency Hopping Function
- Burst Operation at Light Load
- Frequency Reduction Function
- Built-in 730 V Startup Circuit
- Built-in 730 V Switching MOSFET
- VCC UVLO (Under Voltage Lockout)
- VCC OVP (Over Voltage Protection)
- SOURCE Pin Open Protection
- SOURCE Pin Function of Leading Edge Blanking
- Over Current Detection Function per Cycle
- Over Current Detection AC Compensation Function
- Soft Start Function
- Secondary Over Current Protection Circuit

Key Specifications

- Operating Power Supply Voltage Range :
VCC Pin : 8.9 V to 26.0 V
DRAIN Pin : 730 V (Max)
- Circuit Current (ON) 1:
BM2P10x1J-Z: 0.90 mA (Typ)
BM2P10x3J-Z: 0.65 mA (Typ)
- Circuit Current (ON) 2: 0.30 mA (Typ)
- Frequency Range 1: 100 kHz (Typ)
- Operating Temperature Range : -40 °C to +105 °C
- MOSFET ON Resistance:
BM2P10x1J-Z: 1.0 Ω (Typ)
BM2P10x3J-Z: 3.0 Ω (Typ)

Pin Configuration

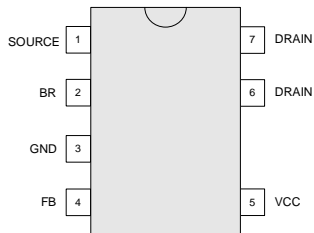

Figure 4. Pin Configuration

Package

DIP7K

W (Typ) x D (Typ) x H (Max)

9.27 mm x 6.35 mm x 8.63 mm

pitch 2.54 mm

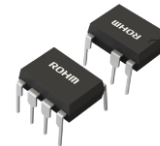

Applications

AC Adapter, TV, Various Home Appliances (Vacuum Cleaner, Humidifier, Air purifier, Air Conditioner, IH Cooking Heater, Rice Cooker, etc.)

Pin Descriptions

No.	Pin name	I/O	Function
1	SOURCE	I/O	MOSFET SOURCE pin
2	BR	I	BROWNOUT pin
3	GND	I/O	GND pin
4	FB	I/O	Feedback-signal-in pin
5	VCC	I	Power supply input pin
6	DRAIN	I/O	MOSFET DRAIN pin
7	DRAIN	I/O	MOSFET DRAIN pin

Measurement Data

1. Load Regulation

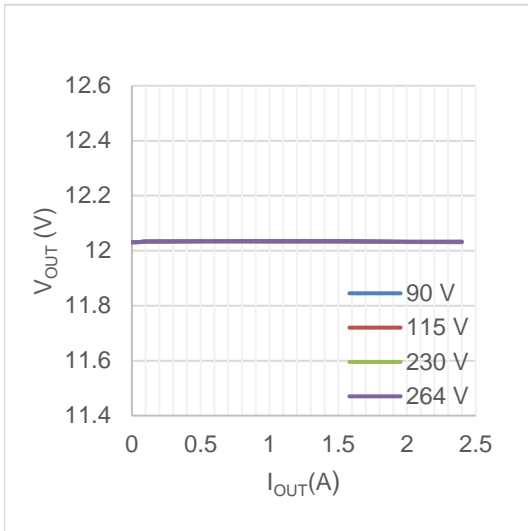

Figure 5. Output Voltage vs Output Current

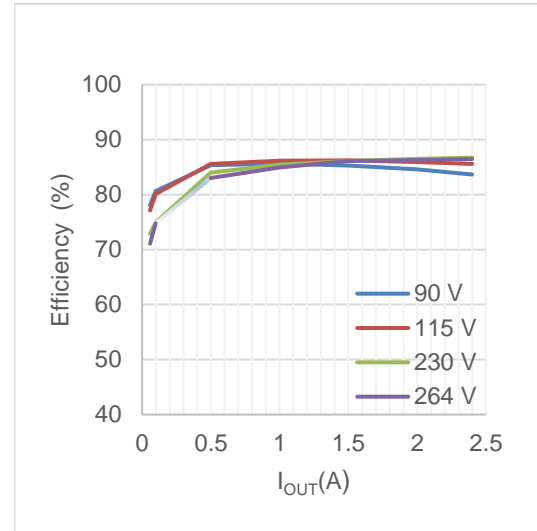

Figure 6. Efficiency vs Output Current

2. Line Regulation

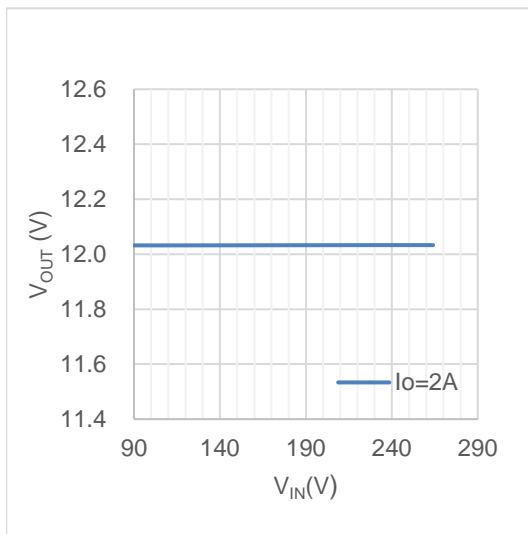

Figure 7. Output Voltage vs Input Voltage

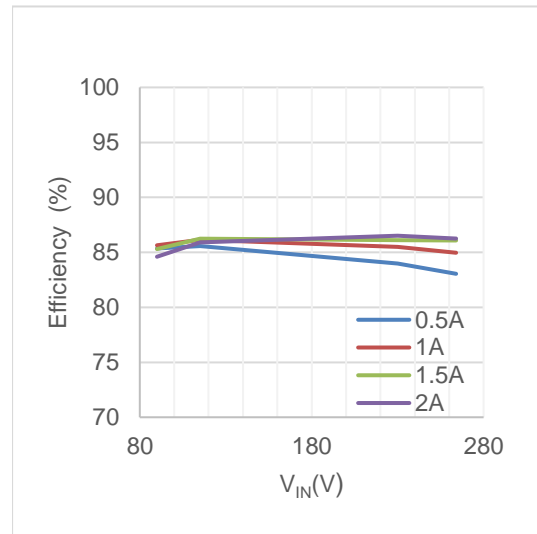

Figure 8. Efficiency vs Input Voltage

Measurement Data – continued

3. Switching Frequency

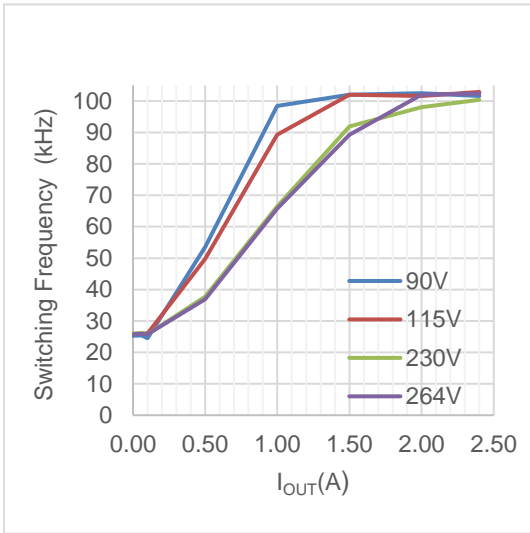

Figure 9. Frequency vs Output Power

4. Input Voltage Slowup

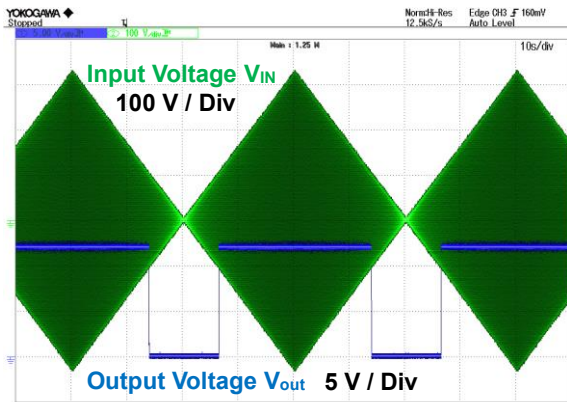

Figure 10. V_{IN} 0 V to 230 V

Measurement Data – continued

5. Switching Wave Form

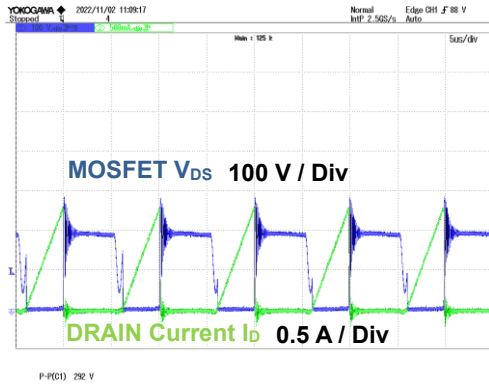

Figure 11. V_{DS} , I_D $V_{IN} = 90$ Vac, $I_{OUT} = 2$ A

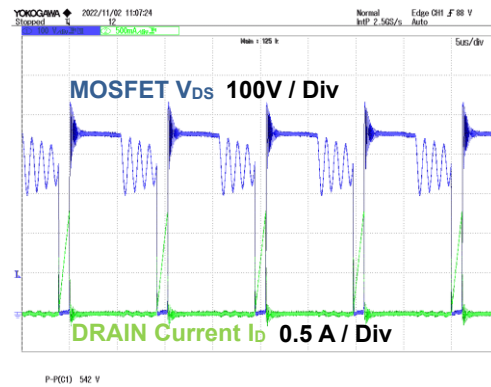

Figure 12. V_{DS} , I_D $V_{IN} = 264$ Vac, $I_{OUT} = 2$ A

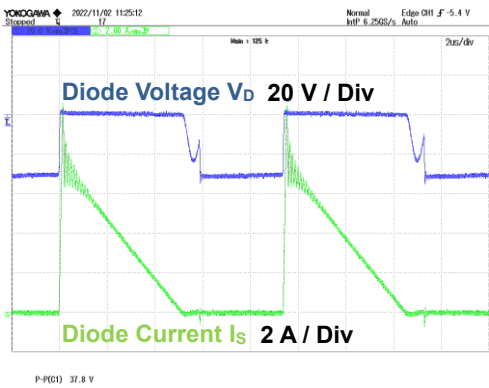

Figure 13. V_D , I_S $V_{IN} = 90$ Vac, $I_{OUT} = 2$ A

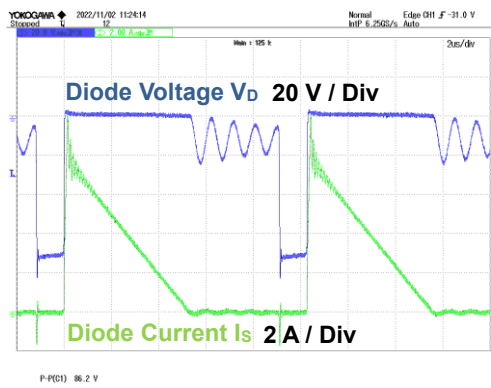

Figure 14. V_D , I_S $V_{IN} = 264$ Vac, $I_{OUT} = 2$ A

Measurement Data – continued

5. Switching Wave Form- continued

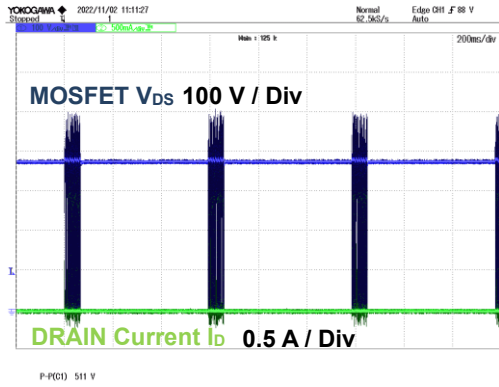

Figure 15. V_{DS} , I_D $V_{IN} = 264 \text{ Vac}$, V_{OUT} Shorted

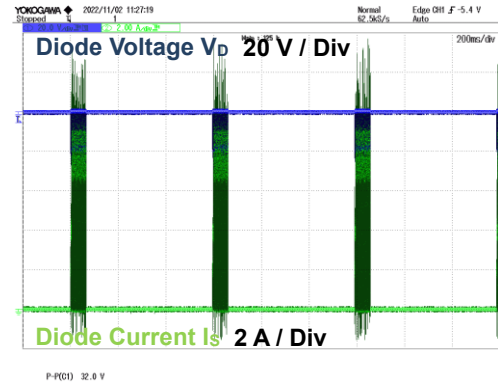

Figure 16. V_D , I_S $V_{IN} = 264 \text{ Vac}$, V_{OUT} Shorted

6. Startup Wave Form

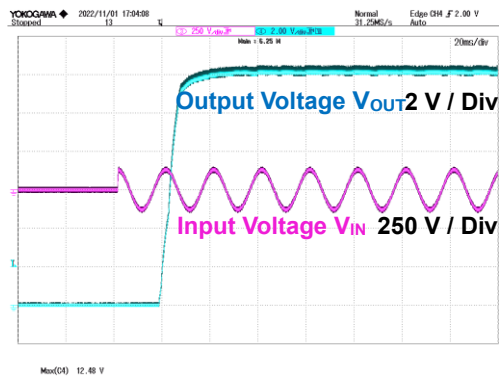

Figure 17. $V_{IN} = 90 \text{ Vac}$, $I_{OUT} = 2\text{A}$

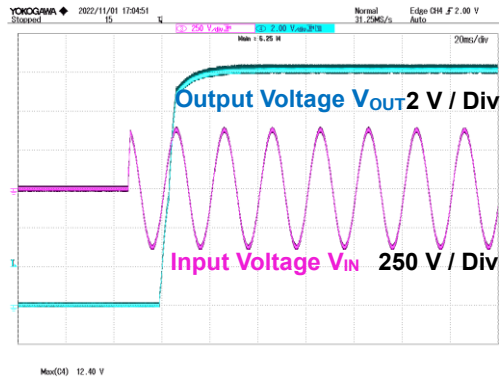

Figure 18. $V_{IN} = 264 \text{ Vac}$, $I_{OUT} = 2\text{A}$

Measurement Data – continued

7. Dynamic Load Fluctuation

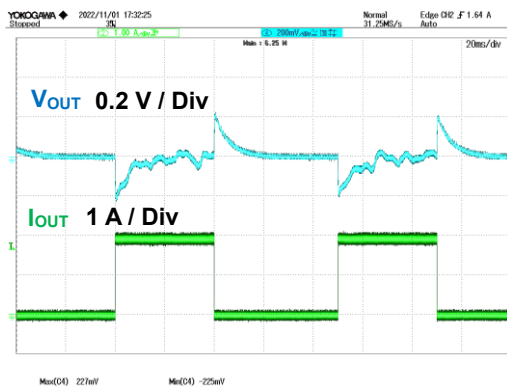

Figure 19. $V_{IN} = 90 \text{ Vac}$, $I_{OUT} = \text{switch } 0.06 \text{ A} / 2 \text{ A}$

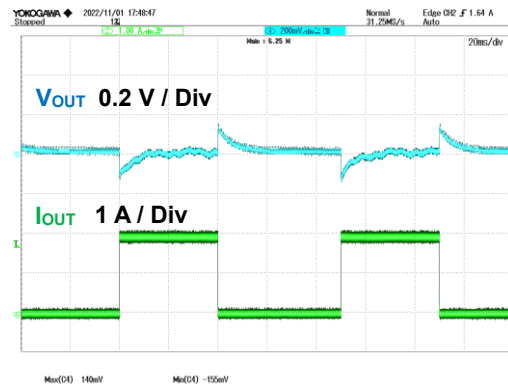

Figure 20. $V_{IN} = 264 \text{ Vac}$, $I_{OUT} = \text{switch } 0.06 \text{ A} / 2 \text{ A}$

8. Output Voltage Ripple Wave Form

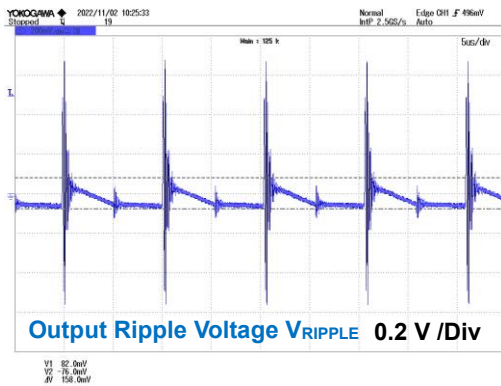

Figure 21. $V_{IN} = 90 \text{ Vac}$, $I_{OUT} = 2 \text{ A}$

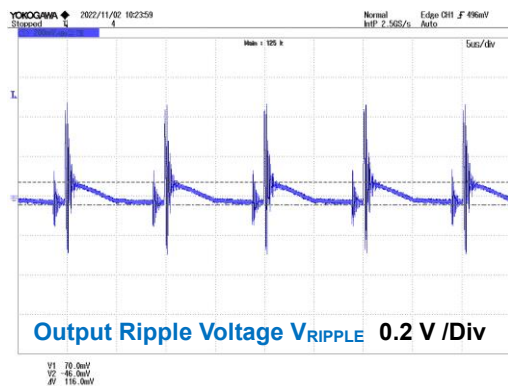

Figure 22. $V_{IN} = 264 \text{ Vac}$, $I_{OUT} = 2 \text{ A}$

9. Temperature of Parts Surface

They are measured after 20 minutes from applying a power supply.

Table 1. Surface Temperature of Parts ($T_a = 29 \text{ }^\circ\text{C}$)

Part	Condition	
	$V_{IN} = 90 \text{ Vac}$, $I_{OUT1} = 2 \text{ A}$	$V_{IN} = 264 \text{ Vac}$, $I_{OUT1} = 2 \text{ A}$
IC1	77.8 $^\circ\text{C}$	78.6 $^\circ\text{C}$
Bridge Diode DB1	78.1 $^\circ\text{C}$	54.9 $^\circ\text{C}$

Measurement Data – continued

10. EMI Conducted Emission: CISPR22 Pub 22 Class B

Limit1 : CISPR Pub 32 Class B
Limit2 : CISPR Pub 32 Class B (AV)

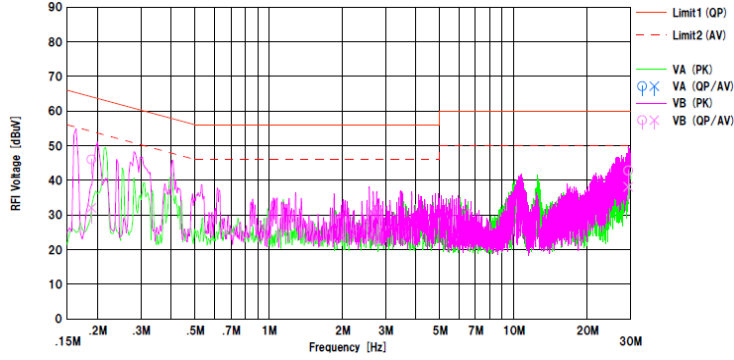

QP margin: 17.2dB
AVE margin: 11.9dB

Figure 23. V_{IN} : 230 Vac / 50 Hz, I_{OUT} : 2 A

Limit1 : CISPR Pub 32 Class B
Limit2 : CISPR Pub 32 Class B (AV)

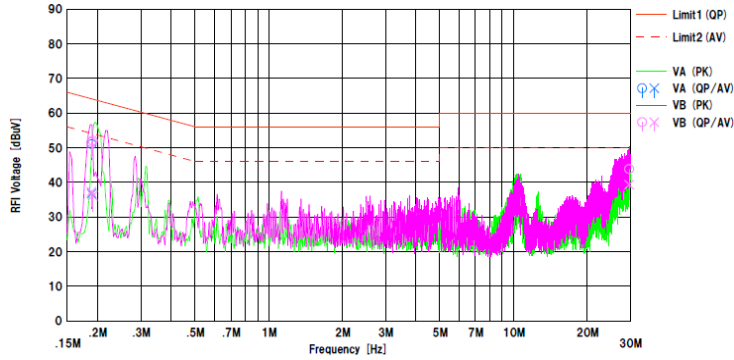

QP margin: 12.0dB
AVE margin: 10.7dB

Figure 24. V_{IN} : 115 Vac / 60 Hz, I_{OUT} : 2 A

Schematics

$V_{IN} = 90 \text{ Vac to } 264 \text{ Vac}$, $V_{OUT} = 12 \text{ V } 2 \text{ A}$

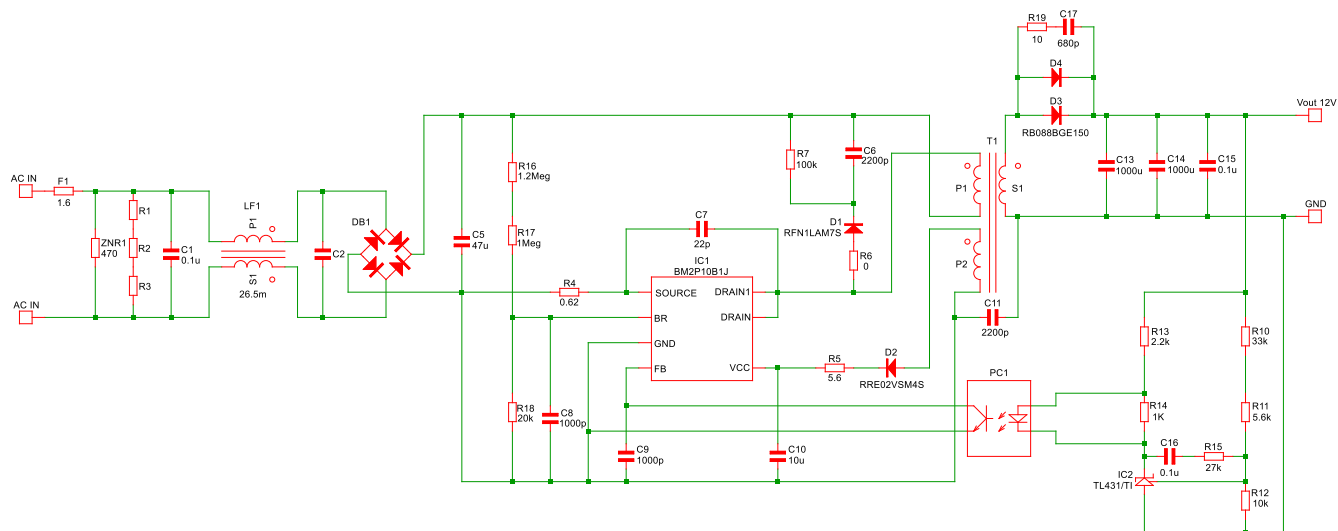

Figure 25. BM2P10B1J-EVK-001 Schematics

Parts List

Item	Specifications	Parts name	Manufacture
C1	0.1 μ F, 275 V	890324023023CS	WURTH ELECTRONIK
C2	Non Mounted	-	-
C5	47 μ F, 450 V	450BXW47MEFR16X25	RUBYCON
C6	2200 pF, 1000 V	G CJ31BR73A222KXJ1K	MURATA
C7	22 pF, 1000 V	RCE5C3A220J2K1H03B	MURATA
C8	1000 pF, 100 V	HMK107B7102KA-T	TAIYO YUDEN
C9	1000 pF, 100 V	HMK107B7102KA-T	TAIYO YUDEN
C10	10 μ F, 35 V	GMK316AB7106KL-TR	TAIYO YUDEN
C11	2200 pF, X1:440 Vac, Y1:300 Vac	DE1E3RA222MA4BP01F	MURATA
C13	1000 μ F, 25 V	UPA1E102MPD3	NICHICON
C14	1000 μ F, 25 V	UPA1E102MPD3	NICHICON
C15	0.1 μ F, 100 V	HMK107B7104KA-T	TAIYO YUDEN
C16	0.1 μ F, 100 V	HMK107B7104KA-T	TAIYO YUDEN
C17	680 pF, 1000 V	GRM31B7U3A681JW31	MURATA
CN1		B2P3-VH	JST
D1	FRD, 0.8 A, 700 V	RFN1LAM7S	ROHM
D2	0.2 A, 400 V	RRE02VSM4S	ROHM
D3	SBD, 10 A, 150 V	RB088BGE150	ROHM
D4	Non Mounted	-	-
DB1	1 A, 800 V	D1UBA80	SHINDENGEN
F1	1.6 A, 300 V	36911600000	LITTELFUSE
GND	BLACK	LC-2-G-BLACK	MAC8
IC1		BM2P10B1J-Z	ROHM
IC2		TL431BIDBZT	TI
LF1	26.5 mH	SSR10VS07265	TOKIN
PC1		LTV-817-B	LITEON
R1	Non Mounted	-	-
R2	Non Mounted	-	-
R3	Non Mounted	-	-
R4	0.62 Ω	LTR100JZPFLR620	ROHM
R5	5.6 Ω	MCR18EZPJ5R6	ROHM
R6	0 Ω	MCR18EZPJ000	ROHM
R7	100 k Ω	MOS2CT52R104J	KOA
R10	33 k Ω	MCR03EZPFX3302	ROHM
R11	5.6 k Ω	MCR03EZPFX5601	ROHM
R12	10 k Ω	MCR03EZPFX1002	ROHM
R13	2.2 k Ω	MCR03EZPJ222	ROHM
R14	1 k Ω	MCR03EZPJ102	ROHM
R15	27 k Ω	MCR03EZPJ273	ROHM
R16	1.2 M Ω	KTR18EZPJ125	ROHM
R17	1 M Ω	KTR18EZPJ105	ROHM
R18	20 k Ω	MCR03EZPJ203	ROHM
R19	10 Ω	ESR18EZPJ100	ROHM
T1	EE25-20	XE2674Y A	ALPHA TRANS
VOUT	WHITE	LC-2-G-WHITE	MAC8
ZNR1	470 V, 400 A, ϕ 5 mm	V470ZA05P	LITTELFUSE

Materials may be changed without notifying.

Layout

Size: 101 mm x 55 mm

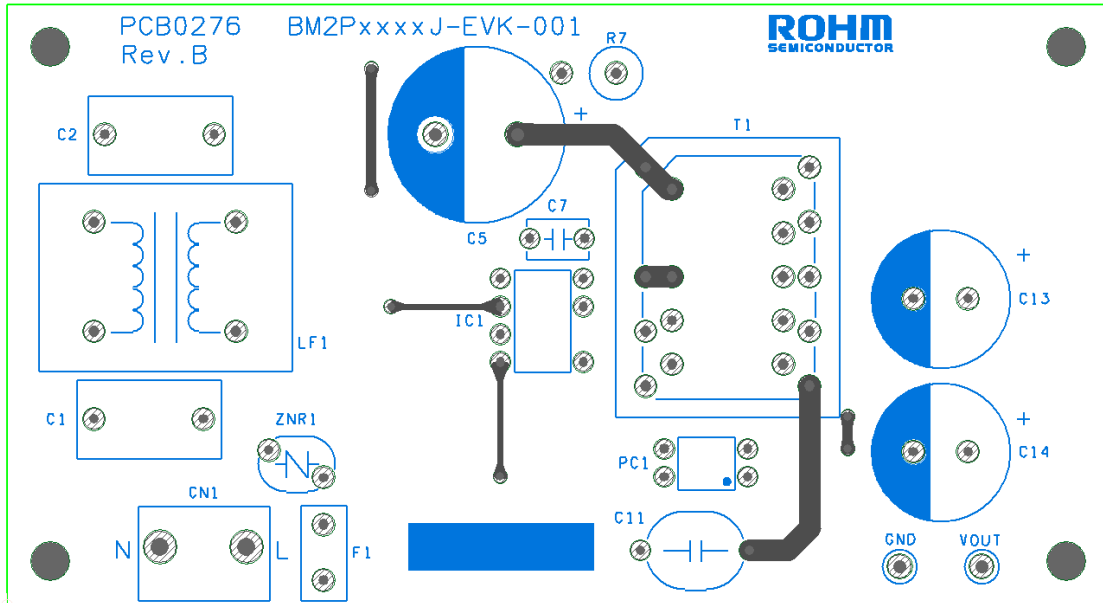

Figure 26. TOP Layout (Top view)

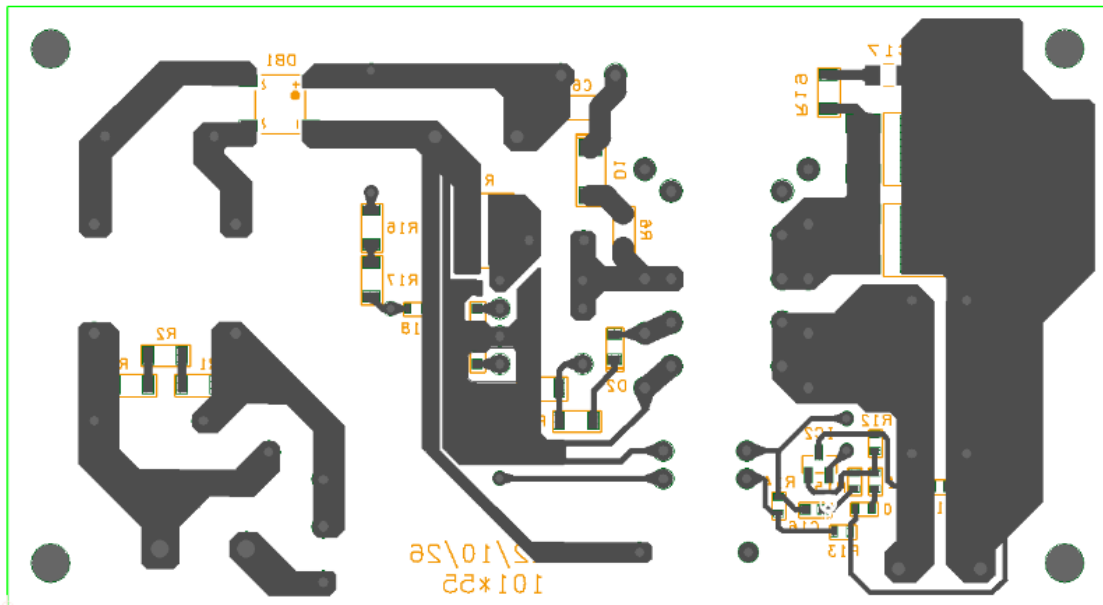

Figure 27. Bottom Layout (Top View)

Revision History

Date	Rev.	Changes
16.Jan.2023	001	New Release
22.May.2023	002	P3 Connect method (4) revised, P15 Table 2 Tape Layer revised, P11 Figure24 title revised

Notice

- 1) The information contained in this document is intended to introduce ROHM Group (hereafter referred to as ROHM) products. When using ROHM products, please verify the latest specifications or datasheets before use.
- 2) ROHM products are designed and manufactured for use in general electronic equipment and applications (such as Audio Visual equipment, Office Automation equipment, telecommunication equipment, home appliances, amusement devices, etc.) or specified in the datasheets. Therefore, please contact the ROHM sales representative before using ROHM products in equipment or devices requiring extremely high reliability and whose failure or malfunction may cause danger or injury to human life or body or other serious damage (such as medical equipment, transportation, traffic, aircraft, spacecraft, nuclear power controllers, fuel control, automotive equipment including car accessories, etc. hereafter referred to as Specific Applications). Unless otherwise agreed in writing by ROHM in advance, ROHM shall not be in any way responsible or liable for any damages, expenses, or losses incurred by you or third parties arising from the use of ROHM Products for Specific Applications.
- 3) Electronic components, including semiconductors, can fail or malfunction at a certain rate. Please be sure to implement, at your own responsibilities, adequate safety measures including but not limited to fail-safe design against physical injury, and damage to any property, which a failure or malfunction of products may cause.
- 4) The information contained in this document, including application circuit examples and their constants, is intended to explain the standard operation and usage of ROHM products, and is not intended to guarantee, either explicitly or implicitly, the operation of the product in the actual equipment it will be used. As a result, you are solely responsible for it, and you must exercise your own independent verification and judgment in the use of such information contained in this document. ROHM shall not be in any way responsible or liable for any damages, expenses, or losses incurred by you or third parties arising from the use of such information.
- 5) When exporting ROHM products or technologies described in this document to other countries, you must abide by the procedures and provisions stipulated in all applicable export laws and regulations, such as the Foreign Exchange and Foreign Trade Act and the US Export Administration Regulations, and follow the necessary procedures in accordance with these provisions.
- 6) The technical information and data described in this document, including typical application circuits, are examples only and are not intended to guarantee to be free from infringement of third parties intellectual property or other rights. ROHM does not grant any license, express or implied, to implement, use, or exploit any intellectual property or other rights owned or controlled by ROHM or any third parties with respect to the information contained herein.
- 7) No part of this document may be reprinted or reproduced in any form by any means without the prior written consent of ROHM.
- 8) All information contained in this document is current as of the date of publication and subject to change without notice. Before purchasing or using ROHM products, please confirm the latest information with the ROHM sales representative.
- 9) ROHM does not warrant that the information contained herein is error-free. ROHM shall not be in any way responsible or liable for any damages, expenses, or losses incurred by you or third parties resulting from errors contained in this document.



Thank you for your accessing to ROHM product informations.
More detail product informations and catalogs are available, please contact us.

ROHM Customer Support System

<https://www.rohm.com/contactus>