

深圳市晶科鑫实业有限公司

Shenzhen Crystal Technology Industrial Co., Ltd

APPROVAL SHEET

CUSTOMER P/N:		
TYPE:	49S DIP CRYSTAL	
DESCRIPTION:	49S 24.576MHZ 20PF ±20PPM -40~85°C	
P N/ SJK:	6BS24576F20UCG	
ENVIRONMENTAL:	<input checked="" type="checkbox"/> RoHS <input checked="" type="checkbox"/> REACH <input checked="" type="checkbox"/> HF <input type="checkbox"/> PAHS <input type="checkbox"/> other	
REVISION:	A1 2014-6-10	MOQ: 1000pcs
MSL:	Levels 1	

SIGNATURE					
SUPPLIER			CUSTOMER		
Issue	Check	Approve	QA	Check	Approve
SJK			Signature		
FAE_EMAIL			Date		
Date			Approve: <input type="checkbox"/> accept <input type="checkbox"/> unaccepted		
Note:					

QUARTZ CRYSTAL UNIT



SERIES 6BS/SS, Resistance Welded HC-49S Package

1. FEATURE

- Leadless type
- High precision characteristic covering up to high frequency range
- Designed for automatic mounting and reflow soldering
- Embossed taping specification
- The best choice of Bluetooth wireless communication sets, DSN, PDA and mobile phone

2. ELECTRICAL SPECIFICATIONS

Output Frequency Range	24.000000MHz
Mode	AT/Fundamental
Frequency Tolerance	±20 ppm max (at 25°C)
Load Capacitance(C _L)	20.0 PF
Frequency Stability Over Operating Temperature Characteristics	±30ppm max
Operating Temperature Range	-40 °C to +85 °C
Storage Temperature Range	-40 °C to +125 °C
Shunt Capacitance (C ₀)	3.0 PF Max
Driver Level (Typical)	100μW
Equivalent Series Resistance(ESR)	30 Ω Max
Aging @25°C 1 st year (Max)	±3ppm/year

QUARTZ CRYSTAL UNIT



SERIES 6BS/SS, Resistance Welded HC-49S Package

3. DIMENSION (Units: mm)

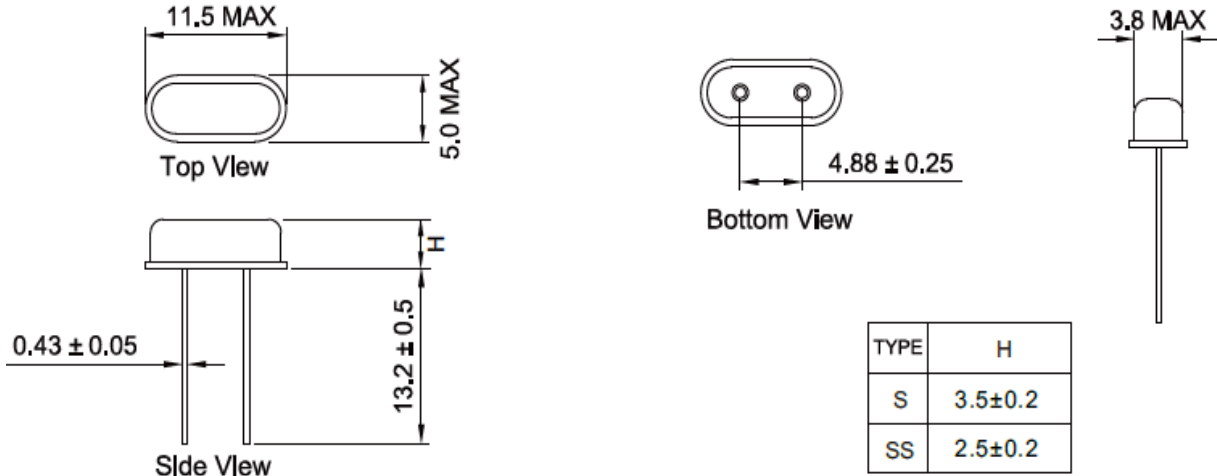

4. MARKING



5. REFLOW CONDITION / 回流焊

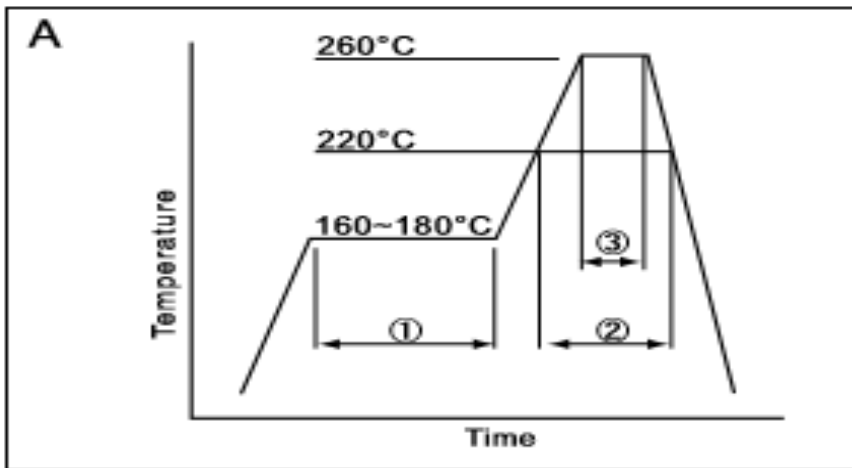

①	Preheat	160~180°C	120sec.
②	Primary heat	220°C	60sec.
③	Peak	260°C	10sec. max

QUARTZ CRYSTAL UNIT



SERIES 6BS/SS, Resistance Welded HC-49S Package

6. RELIABILITY TEST SPECIFICATION

1. Mechanical Endurance

No.	Test Item	Test Methods	REF.DOC
1.1	Drop Test	150 cm height, 3 times on concrete floor.	JIS C6701
1.2	Mechanical Shock	Device are shocked to half sine wave (1000 G) three mutually perpendicular axes each 3 times. 0.5m sec. duration time	MIL-STD-202F
1.3	Vibration	Frequency range 10 ~ 2000 Hz Amplitude 1.52 mm/20G Sweep time 20 minute Perpendicular axes each test time 4 hours (Total test time 12 hours)	MIL-STD-883E
1.4	Gross Leak	Standard Sample For Automatic Gross Leak Detector, Test Pressure: 2Kg / cm ²	MIL-STD-883E
1.5	Fine Leak	Helium Bombing 4.5 Kg/ cm ² for 2 hr	MIL-STD-883E
1.6	Solder ability	Temperature 245 °C ± 5°C Immersing depth 0.5 mm minimum Immersion time 5 ± 1 seconds Flux Rosin resin methyl alcohol solvent (1 : 4)	MIL-STD-883E

2. Environmental Endurance

No.	Test Item	Test Methods	REF.DOC
2.1	Resistance To Soldering Heat	Pre-heat temperature 125 °C Pre-heat time 60 ~ 120 sec. Test temperature 260 ± 5 °C Test time 10 ± 1 sec.	MIL-STD-202F
2.2	High Temp. Storage	+ 125 °C ± 3 °C for 500 ± 12 hours	MIL-STD-883E
2.3	Low Temp. Storage	- 40 °C ± 3 °C for 500 ± 12 hours	MIL-STD-883E
2.4	Thermal Shock	Total 100 cycles of the following temperature cycle 	MIL-STD-883E
2.5	High Temp & Humidity	85°C ± 3°C, RH 85% , 500Hrs	JIS C5023
2.6	Pressure Cooker Storage	121 ± 3°C , RH100% , 2 bar , 240Hrs	JIS C6701