



高速光耦
High Speed Photo
Coupler

ATW720

Product Data Sheet

AOTE DCC
RELEASE

台湾奥特半导体科技有限公司

TAIWAN AOTE SEMICONDUCTOR TECHNOLOGY CO.,LTD

www.aotesemi.com

概述 Description

ATW720 (单通道) 是采用 SOP6 封装的 CMOS 光耦合器。光电耦合器利用最新的 CMOS IC 技术，以极低的功耗实现了卓越的性能。

The ATW720 (single-channel) is CMOS optocouplers in SOP6 package. The optocouplers utilize the latest CMOS IC technology to achieve outstanding performance with very low power consumption.

特性 Features

- CMOS 可兼容：+3.3V 和 +5 V
+3.3V and +5V CMOS compatibility
- 脉冲宽度失真最大值：25ns
25ns max. pulse width distortion
- 传播延迟最大值：55ns
55ns max. propagation delay
- 传播延迟倾斜最大值：40ns
40ns max. propagation delay skew
- 高速：15MBd (最小)
High speed: 15 MBd min
- 共模抑制最小值：10 kV/μs
10 kV/μs minimum common mode rejection
- 温度范围：-40°C ~ 105°C
-40°C to 105°C temperature range
- 无故障上电功能
Glitch-Free Power-UP Feature
- 符合安规标准：UL 1577，VDE DIN EN60747-5-5 (VDE 0884-5)，CQC11-471543-2022
Meet Safety standard：UL 1577, VDE DIN EN60747-5-5 (VDE 0884-5)，CQC11-471543-2022

应用 Applications

- 消除接地回路
Ground loop elimination
- 数字现场总线隔离：RS485, RS232, CANbus
Digital field bus isolation: RS485, RS232, CANbus
- 多路数据传输
Multiplexed data transmission
- 计算机外围接口

真值表 Truth table

LED	VO
OFF	H
ON	L

封装和原理图 Package and Schematic Diagram

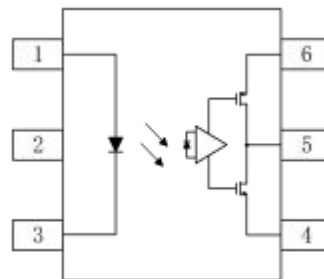

Pin Configuration

1. Anode
2. NC
3. Cathode
4. GND
5. VO
6. VCC

注：在引脚 4 和 6 之间必须连接一个 0.1μF 的旁路电容器。



Note: 0.1μF bypass capacitor must be connected between pins 4 and 6.

产品型号命名规则 Order Code
AT W720 - UN Y - W (V) (ZZ)

① ② ③ ④ ⑤ ⑥ ⑦

- ① 公司代码 Company Code (AT: 奥特 Aote)
- ② 产品系列 Product Series (W720)
- ③ 框架类型 Lead Frame (Cu: 铜框架 Copper)
- ④ 树脂类型 Epoxy Type (H: 无卤 Halogen-free)
- ⑤ 封装形式 Package (S: SOP)
- ⑥ 器件工作温度范围 Device Operating Temperature Range (特殊范围需填或者空白 Special Range need to be filled in or left blank)
- ⑦ 内部补充代码 Internal Supplementary Code (数字或者空白 Number or None)

印字信息 Marking Information

- 印字中 “” 为奥特品牌 LOGO
“” denotes LOGO
- 印字中的 “X” 代表产品分档：0
“X” denotes the classification：0
- 印字中 “Y” 代表年份；A(2018),B(2019),C(2020)
“Y” denotes YEAR：A(2018), B(2019), C(2020)
- 印字中 “WW” 代表周号
“WW” denotes week’s number
- 印字中 “N” 代表星期几
“N” denotes day of the week
- 印字中的 “H” 代表无卤
“H” denotes Halogen-free



绝缘和安规信息 Insulation and Safety related specifications

项目 Item	符号 Symbol	数值 Value	单位 Unit	备注 Remark
爬电距离 Creepage Distance	L	>8.0	mm	从输入端到输出端，沿本体最短距离路径 Measured from input terminals to output terminals, shortest distance path along body
电气间隙 Clearance Distance	L	>8.0	mm	从输入端到输出端，通过空气的最短距离 Measured from input terminals to output terminals, shortest distance through air
绝缘距离 Insulation Thickness	DTI	>0.4	mm	发射器和探测器之间的绝缘厚度 Insulation thickness between emitter and detector
峰值隔离电压 Peak Isolation Voltage	V_{IORM}	1500	V_{peak}	DIN/EN/IEC EN60747-5-5
瞬态隔离电压 Transient isolation voltage	V_{IOTM}	7000	V_{peak}	DIN/EN/IEC EN60747-5-5
隔离电压 Isolation Voltage	V_{iso}	>5000	Vrms	For 1 min

极限参数 Absolute Maximum Ratings (Ta = 25°C)

参数 Parameter	符号 Symbol	最小值 Min.	最大值 Max.	单位 Unit
电源电压 Supply Voltages	V_{DD}	0	6.0	V
输出电压 Output Voltage	V_O	-0.5	VDD+0.5	V
平均正向输入电流 Average Forward Input Current	I_F	-	10.0	mA
平均输出电流 Average Output Current	I_O	-	10.0	mA
隔离电压 Isolation voltage	V_{ISO}	5000	-	Vrms
工作温度 Operating Temperature	T_{opr}	-40	+105	°C
存储温度 Storage Temperature	T_{stg}	-55	+125	°C
铅焊温度 Lead Solder Temperature	T_{SOL}	260 摄氏度持续 10 秒，座位平面以下 1.6mm 260°C for 10 sec, 1.6 mm below seating plane		
焊机回流温度曲线 Solder Reflow Temperature Profile	请参阅回流焊温度曲线部分 See Solder Reflow Temperature Profile Section			

推荐工作条件 Recommended Operating Conditions

参数 Parameter	符号 Symbol	最小值 Min.	最大值 Max.	单位 Unit
电源电压 Supply Voltages	V_{DD}	4.5	5.5	V
		3	3.6	V
开启电流 Forward Input Current (ON)	$I_{F(ON)}$	3	10	mA
关断电压 Forward Input Voltage (OFF)	$V_{F(OFF)}$	0	1.3	V
操作温度 Operating Temperature	T_A	-40	105	°C

产品特性参数 Electro-optical Characteristics ($T_a = 25^\circ\text{C}$, $V_{DD} = 3.3\text{V}$)

参数 Parameter		符号 Symbol	条件 Condition	最小 Min.	典型 Typ.	最大 Max.	单位 Unit
发射端 Input	正向电压 Forward Voltage	V_F	$I_F = 6\text{mA}$	1	1.3	1.8	V
	反向击穿电压 Reverse Breakdown Voltage	B_{VR}	$I_R = 10\mu\text{A}$	5.0	-	-	V
接收端 Output	逻辑高输出电压 Logic High Output Voltage	V_{OH}	$I_F = 0, I_O = -4\text{mA}, V_{DD} = 3.3\text{V}$	$V_{DD} - 1$	$V_{DD} - 0.3$	-	V
			$I_F = 0, I_O = -4\text{mA}, V_{DD} = 5\text{V}$	$V_{DD} - 1$	$V_{DD} - 0.2$	-	V
	逻辑低输出电压 Logic Low Output Voltage	V_{OL}	$I_F = 6\text{mA}, I_O = 4\text{mA}, V_{DD} = 3.3\text{V}$	-	0.2	0.8	V
			$I_F = 6\text{mA}, I_O = 4\text{mA}, V_{DD} = 5\text{V}$	-	0.35	0.8	V
	输入阈值电流 Input Threshold Current	I_{TH}	$I_{OL} = 20\mu\text{A}$	-	3	5	mA
	逻辑低输出电源电流 Logic Low Output Supply Current	I_{DDL}	$I_F = 6\text{mA}$	-	4.5	6.5	mA
	逻辑高输出电源电流 Logic High Output Supply Current	I_{DDH}	$I_F = 0$	-	4	6	mA

开关特性 Switching Specification (Ta = 25 °C, V_{DD} = 3.3 V)

参数 Parameter	符号 Symbol	条件 Condition	最小 Min.	典型 Typ.	最大 Max.	单位 Unit
逻辑低电平传输延迟 Propagation Delay Time to Low Output Level	t _{PHL} ¹	I _F = 6mA, C _L = 15pF CMOS Signal Levels	-	40	55	ns
逻辑高电平传输延迟 Propagation Delay Time to High Output Level	t _{PLH} ¹		-	36	55	
脉冲宽度 Pulse Width	t _{PW}		66.7	-	-	
脉宽失真 Pulse Width Distortion t _{PHL} - t _{PLH}	PWD		0	4	25	
传播延迟偏斜 Propagation Delay Skew	t _{PSK}		-	-	40	
输出上升时间 Output Rise Time (10% ~ 90%)	t _R		-	3.5	-	
输出下降时间 Output Fall Time (90% ~ 10%)	t _F		-	3.5	-	
输出高电平共模抑制 Output High Level Common Mode Transient Immunity	CMH ²	VCM =1000V I _F =0mA	10	15	-	kV/μs
输出低电平共模抑制 Output Low Level Common Mode Transient Immunity	CML ³	VCM =1000V I _F =6.0mA	10	15	-	

注：Note:

- 从输入脉冲上升沿的 50%V_{DD} 电平到 V_O 信号下降沿的 50%V_{DD} 电平，测量 t_{PHL} 传播延迟。从输入脉冲下降沿的 50%V_{DD} 水平到 V_O 信号上升沿的 50%V_{DD} 水平，测量 t_{PLH} 传播延迟。
t_{PHL} propagation delay is measured from the 50% V_{DD} level on the rising edge of the input pulse to the 50% V_{DD} level of the falling edge of the V_O signal. t_{PLH} propagation delay is measured from the 50% V_{DD} level on the falling edge of the input pulse to the 50% V_{DD} level of the rising edge of the V_O signal.
- CMH 是共模电压上升的最大可容忍速率，以确保输出将保持在高逻辑状态。
CMH is the maximum tolerable rate of rise of the common mode voltage to assure that the output will remain in a high logic state.
- CML 是共模电压的最大可容忍的下降率，以确保输出将保持在低逻辑状态。
CML is the maximum tolerable rate of fall of the common mode voltage to assure that the output will remain in a low logic state.

典型光电特性曲线 Typical Electro-Optical Characteristics Curves

Fig.1 Input current vs. Forward Voltage

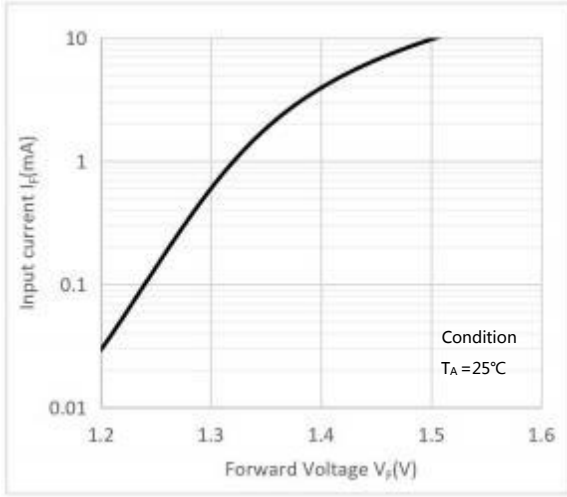

Fig.2 Input threshold current vs. Ambient temperature

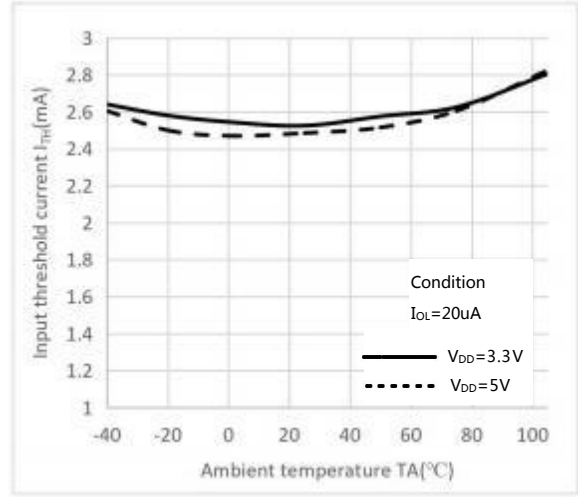

Fig.3 Logic high output supply current vs. Ambient temperature

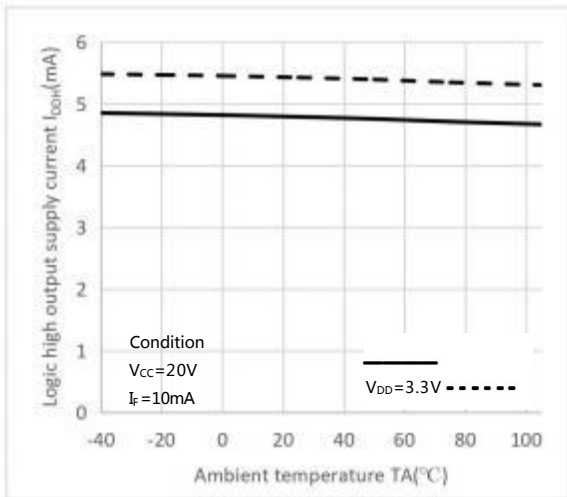

Fig.4 Logic low output supply current vs. Ambient temperature

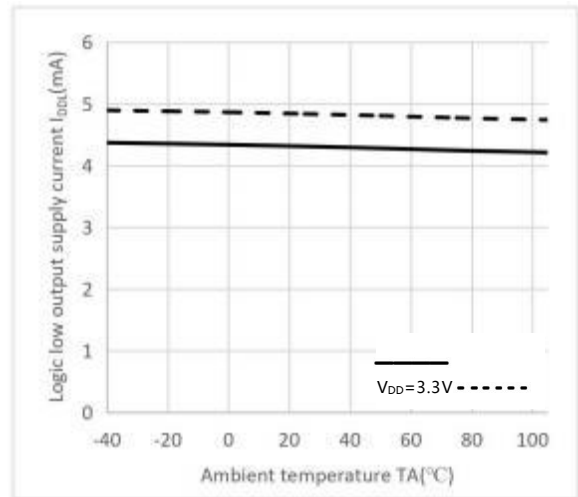

Fig.5 Propagation delay vs. Pulse input current

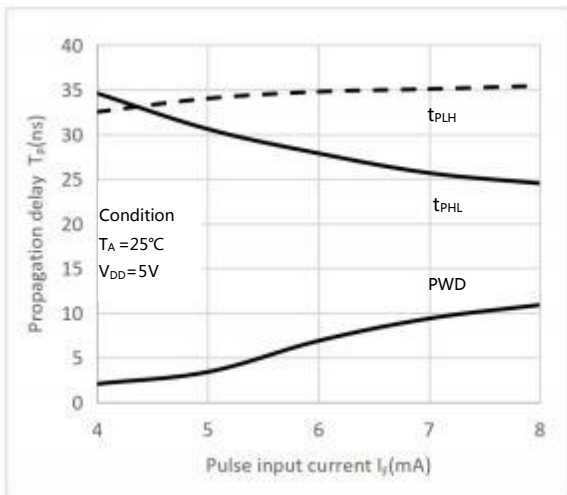

Fig.6 Propagation delay vs. Pulse input current

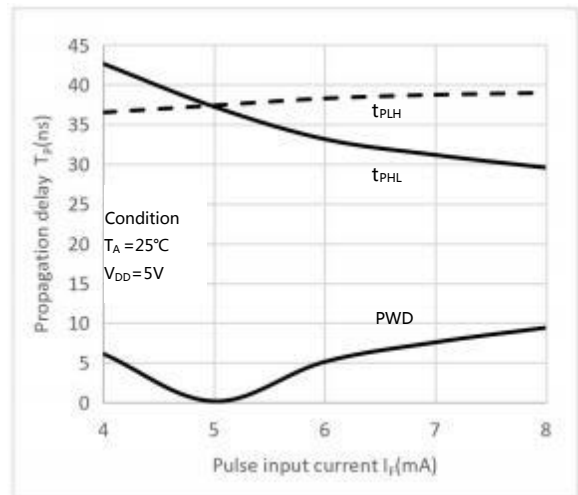

Fig.7 Forward voltage vs. Ambient temperature

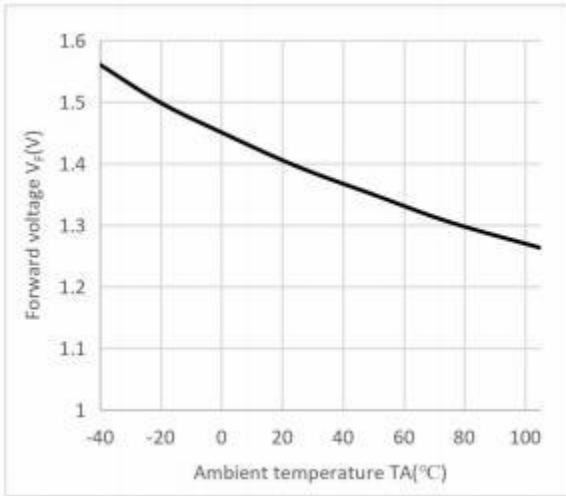

Fig.8 Propagation delay vs. Ambient temperature
($V_{DD}=5V, C_{peak}=100pF, R_{limit}=530\ \Omega$)

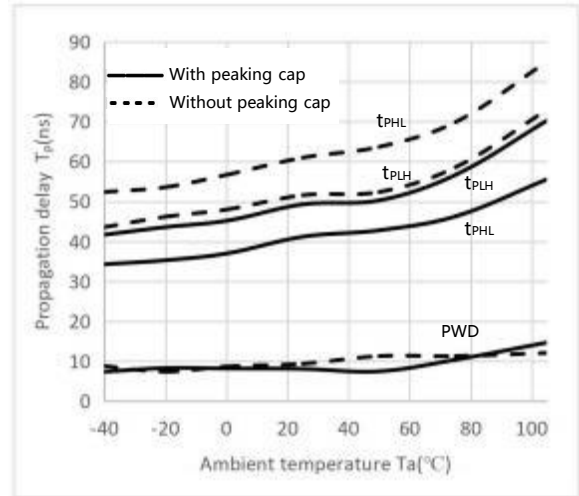
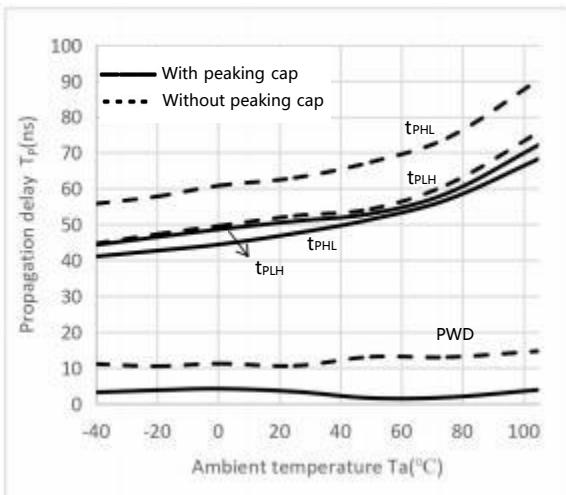
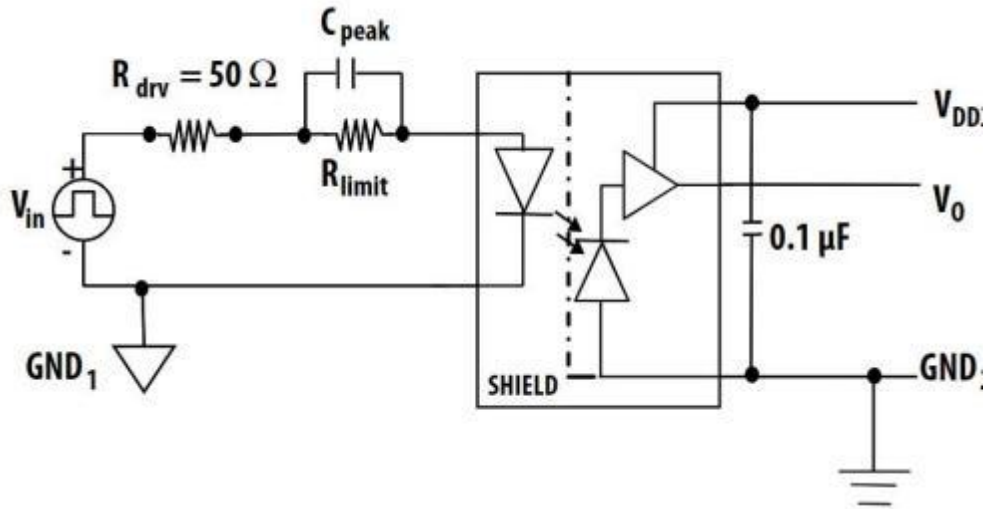

Fig.9 Propagation delay vs. Ambient temperature
($V_{DD}=3.3V, C_{peak}=100pF, R_{limit}=250\ \Omega$)



延迟时间测试电路 Propagation Delay Time Test Circuit



CMR 测试电路 Test Circuit for Common Mode Transient Immunity

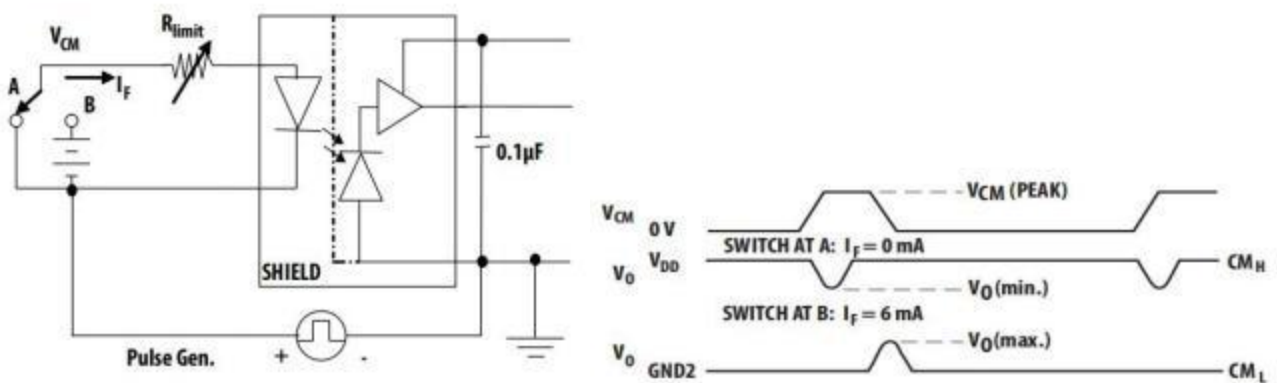

外形尺寸 Outline Dimensions

SOP6-W

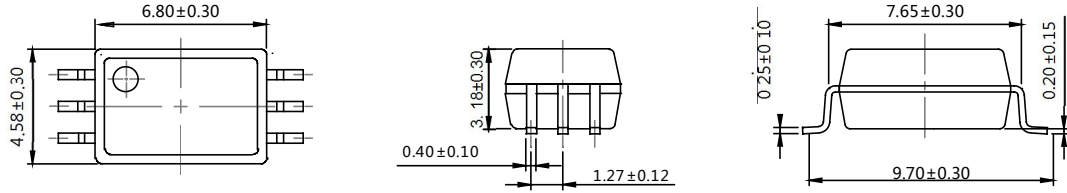

SOP6-P

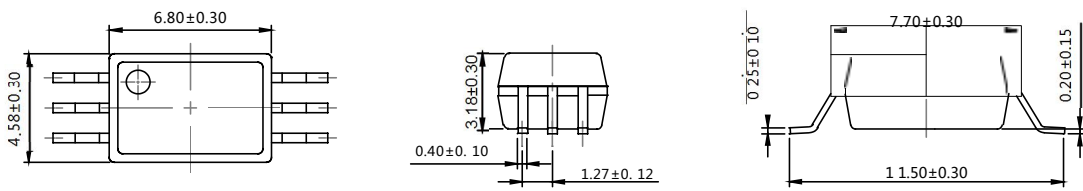

单位 Unit: mm

建议焊盘布局 Recommended Pad Layout

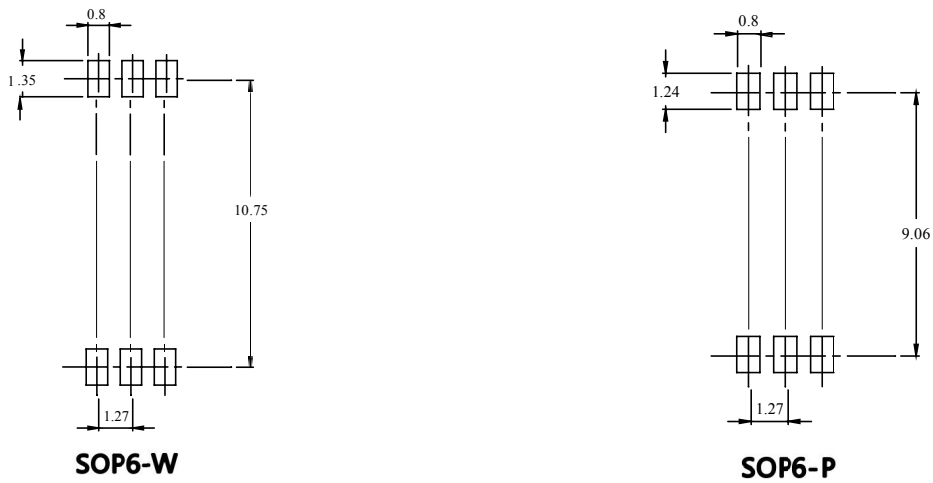

单位 Unit: mm

注：上图为产品正视图。
Note : The picture above is the front view of the product.

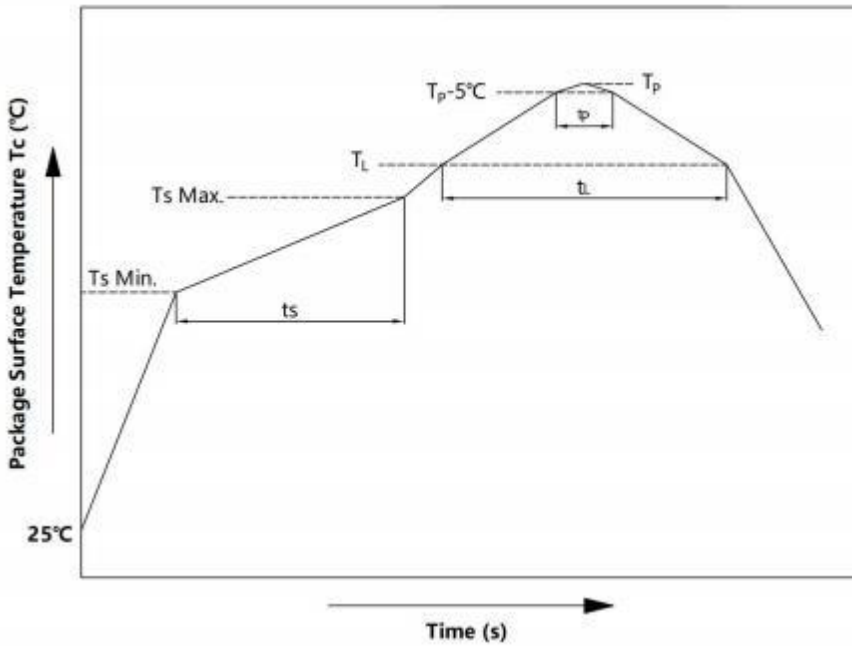
回流焊温度曲线图 Solder Reflow Profile

项目 Item	符号 Symbol	最小值 Min.	最大值 Max.	单位 Unit
预热温度 Preheat Temperature	Ts	150	200	°C
预热时间 Preheat Time	ts	60	120	s
升温速率 Ramp-Up Rate (T _L to T _p)	-	-	3	°C/s
液相线温度 Liquidus Temperature	T _L	217		°C
时间高于 T _L Time Above T _L	t _L	60	150	s
峰值温度 Peak Temperature	T _p	-	260	°C
Tc 在(T _p -5)和 T _p 之间的时间 Time During Which Tc Is Between (T _p -5) and T _p	t _p	-	30	s
降温速率 Ramp-down Rate(T _p to T _L)	-	-	6	°C/s

注 Note :

建议在所示的温度和时间条件下进行回流焊，最多不能超过三次；

Reflow soldering is recommended at the temperatures and times shown, no more than three times;

波峰焊温度曲线图 Wave Soldering Profile

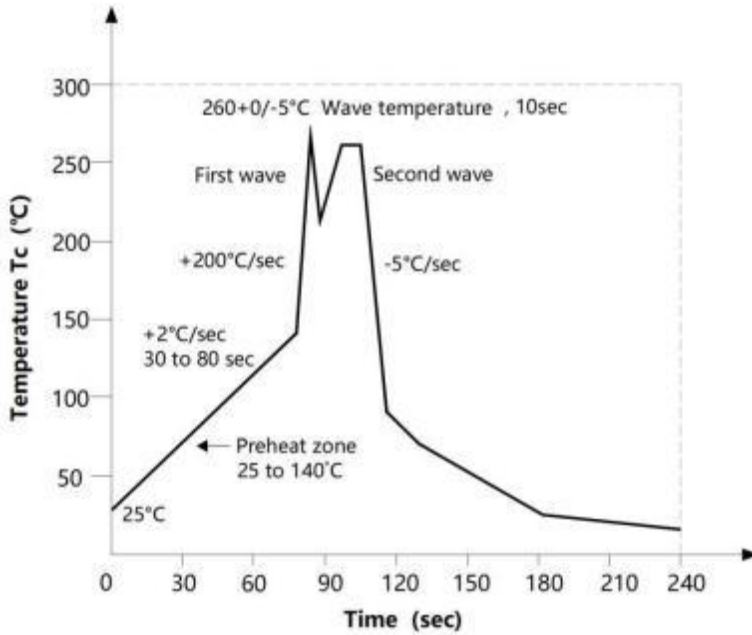

手工烙铁焊接 Soldering with hand soldering iron

- A. 手工烙铁焊仅用于产品返修或样品测试；
Hand soldering iron is only used for product rework or sample testing;
- B. 手工烙铁焊要求：温度 $360^{\circ}\text{C} \pm 5^{\circ}\text{C}$ ，时间 $\leq 3\text{s}$ 。
Hand soldering iron requirements：Temperature： $360^{\circ}\text{C} \pm 5^{\circ}\text{C}$, within 3s.

包装 Packing

■ 汇总表 Summary table

封装形式	包装方式	盘数量	盒数量	箱数量	静电袋规格	盒规格	箱(双瓦楞)规格	备注
SOP6	卷盘 (φ330mm 蓝盘)	1千只/盘	2盘/盒	10盒/箱	450*390*0.1mm	340*60*340mm	620*360*365mm	首尾端空至少 200mm
Package Type	Packing Form	Quantity per Reel	Quantity per Box	Quantity per Carton	Antistatic Bag Specification	Box Specification	Carton Specification	Note
SOP6	Reel(φ330mm Blue)	1k pcs/reel	2Reel/box	10box/ctn	450*390*0.1mm	340*60*340mm	620*360*365mm	Guard band 200mm min.

■ 编带包装 Tape & Reel

- 1) 每卷数量：1000只。
Qty/reel：1000 pcs.
- 2) 每箱数量：20000只。
Qty/ctn：20000 pcs.
- 3) 内包装：每卷盘1000只。
Inner packing：1000pcs/reel.
- 4) 示意图 Schematic：

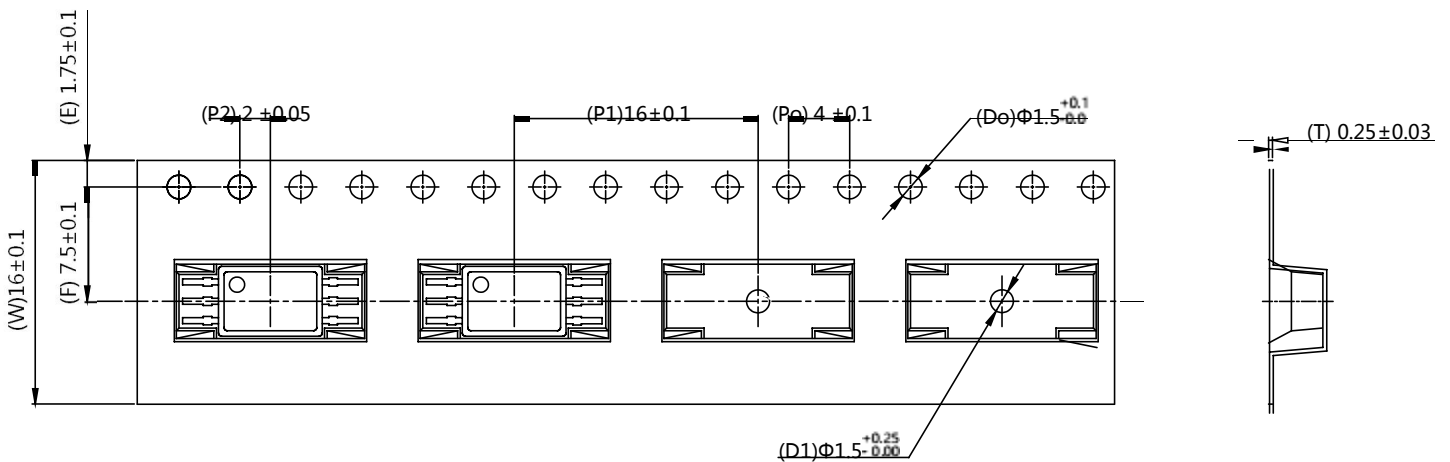

单位 Unit：mm

注意 Attention

- 奥特持续不断改进质量、可靠性、功能或设计，保留此文件更改的权利恕不另行通知。
AOTE continuously improve quality, reliability, function and design. We reserve the right to change this document without prior notice.
- 请遵守产品规格书使用，奥特不对使用时不符合产品规格书条件而导致的质量问题负责。
Please use in accordance with the product specification. AOTE is not responsible for the quality problems caused by non-compliance with the product specifications.
- 对于需要高可靠性或安全性的设备/装置需求，请联系我们的销售人员。
For equipment/devices requiring high reliability or safety, please contact our sales representatives.
- 当需要用于任何“特定”应用时，请咨询我们的销售人员。
When requiring a device for any “specific” application, please contact our sales in advice.
- 如对文件中表述的内容有疑问，欢迎联系我们。
If you have any questions about the contents of the document, please contact us.