



## 高速光耦

High Speed Photo Coupler

# 6N137S

Product Data Sheet

**AOTE DCC**  
**RELEASE**

**台湾奥特半导体科技有限公司**

TAIWAN AOTE SEMICONDUCTOR TECHNOLOGY CO.,LTD

[www.aotesemi.com](http://www.aotesemi.com)

## 概述 Description

6N137S 是一种用于单通道的高速光耦合器，由一个 850nm 的 AlGaAs LED 光学耦合到一个高速光电检测器组成。光电二极管偏极和输出晶体管集电极的单独连接，可以通过降低基极集电极电容，使速度比传统光电晶体管耦合器提高 100 倍。

The 6N137S optocoupler consists of an 850nm AlGaAs LED optically coupled to a high speed photodetector transistor. A separate connection for the bias of the photodiode improves the speed by several orders of magnitude over conventional phototransistor optocouplers by reducing the base-collector capacitance of the input transistor.

## 特性 Features

- 高比特率：1MBit/s  
High bit rate：1MBit/s
- 输入-输出隔离电压 ( $V_{ISO}=5000\text{ Vrms}$ )  
High isolation voltage between input and output ( $V_{ISO}=5000\text{ Vrms}$ )
- 兼容 TTL  
TTL Compatible
- 集电极开路输出  
Open-Collector Output
- 符合加强绝缘标准  
Meet reinforced insulation standards
- 符合安规标准：UL 1577，VDE DIN EN60747-5-5 (VDE 0884-5)，CQC11-471543-2022  
Meet Safety standard：UL 1577, VDE DIN EN60747-5-5 (VDE 0884-5)，CQC11-471543-2022

## 应用 Applications

- CMOS-LSTTL-TTL 的输出接口  
Output interface to CMOS-LSTTL-TTL
- 通信设备  
Telecommunication equipment
- 电机驱动器中的功率晶体管隔离  
Power transistor isolation in motor drives
- 替换低速光晶体管光耦合器  
Replacement for low speed phototransistor photo couplers

## 真值表 Truth table

LED	VO
OFF	H
ON	L

## 封装和原理图 Package and Schematic Diagram



DIP8



SMD8

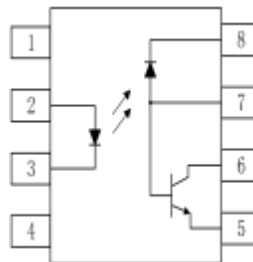



### Pin Configuration

1.NC	8.VCC
2. Anode	7.VB
3. Cathode	6.VO
4. NC	5.GND

注：在引脚 5 和 8 之间必须连接一个 0.1uF 的旁路电容器。

Note: 0.1uF bypass capacitor must be connected between pins 5 and 8.

## 印字信息 Marking Information

- 印字中 “” 为奥特品牌 LOGO  
“” denotes LOGO
- 印字中 “Y” 代表年份； A(2018),B(2019),C(2020) ... ..  
“Y” denotes YEAR： A(2018), B(2019), C(2020) ... ..
- 印字中 “WW” 代表周号  
“WW” denotes week’ s number
- 印字中 “N” 代表星期几  
“N” denotes day of the week
- 印字中的 “H” 代表无卤  
“H” denotes Halogen-free

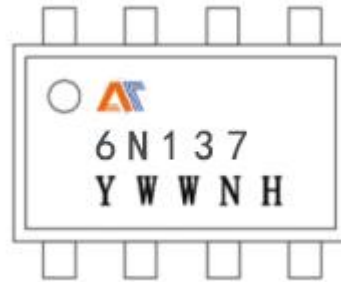

**绝缘和安规信息 Insulation and Safety related specifications**

项目 Item	符号 Symbol	数值 Value	单位 Unit	备注 Remark
爬电距离 Creepage Distance	L	> 7.6	mm	从输入端到输出端，沿本体最短距离路径 Measured from input terminals to output terminals, shortest distance path along body
电气间隙 Clearance Distance	L	> 7.6	mm	从输入端到输出端，通过空气的最短距离 Measured from input terminals to output terminals, shortest distance through air
绝缘距离 Insulation Thickness	DTI	> 0.4	mm	发射器和探测器之间的绝缘厚度 Insulation thickness between emitter and detector
峰值隔离电压 Peak Isolation Voltage	$V_{IORM}$	1500	$V_{peak}$	DIN/EN/IEC EN60747-5-5
瞬态隔离电压 Transient isolation voltage	$V_{IOTM}$	7000	$V_{peak}$	DIN/EN/IEC EN60747-5-5
隔离电压 Isolation Voltage	$V_{iso}$	> 5000	Vrms	For 1 min

**极限参数 Absolute Maximum Ratings (Ta = 25°C)**

参数 Parameter		符号 Symbol	额定值 Rating	单位 Unit
发射端 Input	平均正向输入电流 DC/Average forward input current	$I_{F(avg)}$	25	mA
	峰值正向输入电流 (50%占空比, 1ms p.w) Peak forward input current (50% duty cycle, 1 ms p.w.)	$I_{F(pk)}$	50	mA
	反向输入电压 Reverse input voltage	$V_R$	5	V
	峰值瞬态输入电流 (脉宽 $\leq 1 \mu s$ p.w., 300pps) Peak transient input current ( $\leq 1 \mu s$ p.w., 300 pps)	$I_{F(trans)}$	1	A
	输入功耗 Input power dissipation	$P_I$	45	mW
接收端 output	电源电压 Supply voltage	$V_{CC}$	-0.5 ~ 30	V
	输出电流 Output current	$I_O$	8	mA
	峰值输出电流 Peak output current	$I_{O(pk)}$	16	mA
	输出功耗 Output power dissipation	$P_O$	100	mW
	输出电压 Output voltage	$V_O$	-0.5 ~ 20	V
	发射极-基极反向电压 Emitter-base reverse voltage	$V_{EBR}$	5	V
	基极电流 Base current	$I_B$	5	mA

参数 Parameter	符号 Symbol	额定值 Rating	单位 Unit
工作温度 Operating Temperature	$T_{opr}$	-40 ~ +100	°C
存储温度 Storage Temperature	$T_{stg}$	-55 ~ +125	°C
焊接温度 Soldering Temperature	$T_{sol}$	260 for 10 sec	°C

### 推荐操作条件 Recommended Operating Conditions

参数 Parameter	符号 Symbol	最小值 Min	最大值 Max	单位 Unit
电源电压 Power Supply Voltage	$V_{CC}$	4.5	18	V
开启电流 Forward Input Current (ON)	$I_{F(ON)}$	6.0	20.0	mA
关断电压 Forward Input Voltage (OFF)	$V_{F(OFF)}$	0	1.3	V
操作温度 Operating Temperature	$T_A$	-40	+100	°C

**产品特性参数 Electro-optical Characteristics (Ta = 25°C)**

参数 Parameter		符号 Symbol	条件 Condition	最小 Min.	典型 Typ.	最大 Max.	单位 Unit	
发射端 Input	正向电压 Forward Voltage	$V_F$	$I_F=16mA$	-	145	1.7	V	
	反向击穿电压 Reverse Breakdown Voltage	$BV_R$	$I_R=10\mu A$	5	20	-	V	
	正向电压的温度系数 Diode Temperature Coefficient	$\Delta V_F/\Delta T_A$	$I_F=16mA$	-	-1.6	-	mV/°C	
接收端 Output	高电平电源电流 High Level Supply Current	$I_{CCH}$	$V_{CC}=15V$ $I_F=0mA$ $V_O=Open$	-	-	1	$\mu A$	
			$T_A=0 \sim 70^\circ C$	-	-	2	$\mu A$	
	低电平电源电流 Low Level Supply Current	$I_{CCL}$	$V_{CC}=15V$ $I_F=16mA$ $V_O=Open$	-	50	200	$\mu A$	
传输特性 Transfer Characteristics	高电平输出电流 HIGH Level Output Current	$I_{OH}$	$I_F=0mA$ $V_O=V_{CC}=5.5V$	-	0.001	0.5	$\mu A$	
			$I_F=0mA$ $V_O=V_{CC}=15V$	-	0.005	1		
			$T_A=0-70^\circ C$ $V_O=V_{CC}=15V$	-	-	50		
	低电平输出电压 LOW Level Output Voltage	$V_{OL}$	6N135	$I_F=16mA$ $V_{CC}=4.5V$ $I_O=1.1mA$	-	0.1	0.4	V
			6N136	$I_F=16mA$ $V_{CC}=4.5V$ $I_O=3mA$	-	0.1	0.4	V
电流传输比* Current Transfer ratio*	CTR	6N135	$I_F=16mA$ $V_{CC}=4.5V$ $V_O=0.4V$	7	18	50	%	
		6N136		19	24	50		
隔离电压 Isolation Voltage	$V_{ISO}$		$R_H < 50\%$ $T_A = 25^\circ C$ $I_{I-O} \leq 50\mu A$	5000	-	-	$V_{RMS}$	
隔离电阻 Isolation Resistance	$R_{I-O}$		$V_{I-O} = 500V$	-	$10^{12}$	-	$\Omega$	
隔离电容 Isolation Resistance	$C_{I-O}$		$f=1MHz$	-	0.6	-	pF	

 注\*：电流传输比= $I_C/I_F \times 100\%$ 。

 Note\*：CTR= $I_C/I_F \times 100\%$ 。

## 开关特性 Switching Specification

参数 Parameter	符号 Symbol	条件 Condition	最小 Min.	典型 Typ.	最大 Max.	单位 Unit
输出高电平传播延迟 Propagation Delay Time to High Output Level	$T_{PLH}$	6N135 $I_F = 16\text{mA}$ , $R_L = 4.1\text{k}\Omega$	-	1300	1500	ns
		6N136 $I_F = 16\text{mA}$ , $R_L = 1.9\text{k}\Omega$		600	800	
输出低电平传播延迟 Propagation Delay Time to Low Output Level	$T_{PHL}$	6N135 $I_F = 16\text{mA}$ , $R_L = 4.1\text{k}\Omega$	-	200	1500	ns
		6N136 $I_F = 16\text{mA}$ , $R_L = 1.9\text{k}\Omega$		200	800	
输出高电平共模瞬态抑制 Common Mode Transient Immunity at High Output Level	$ CM_H $	$R_L = 4.1\text{k}\Omega$	1000	-	-	V/ $\mu\text{s}$
		$T_A = 25^\circ\text{C}, I_F = 0\text{mA}$ $ V_{CM}  = 10\text{V(Peak)}$ $C_L = 15\text{pF}$				
输出低电平共模瞬态抑制 Common Mode Transient Immunity at Low Output Level	$ CM_L $	$R_L = 4.1\text{k}\Omega$	1000	-	-	V/ $\mu\text{s}$
		$T_A = 25^\circ\text{C}, I_F = 16\text{mA}$ $ V_{CM}  = 10\text{V(Peak)}$ $C_L = 15\text{pF}$				

典型光电特性曲线 Typical Electro-Optical Characteristics Curves

Fig.1 Normalized CTR vs. Input current

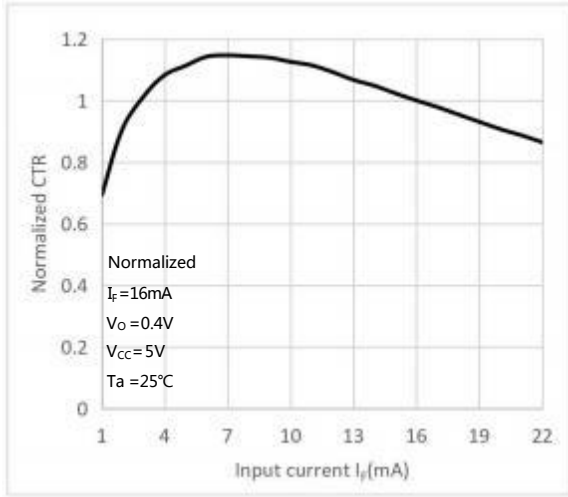

Fig.2 Normalized CTR vs. Ambient temperature

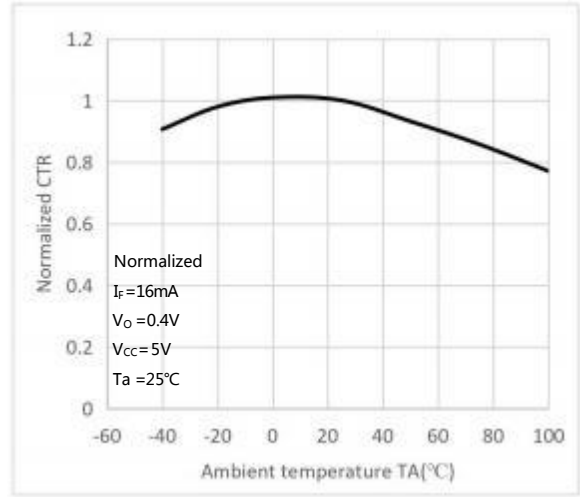

Fig.3 Output current vs. Output voltage

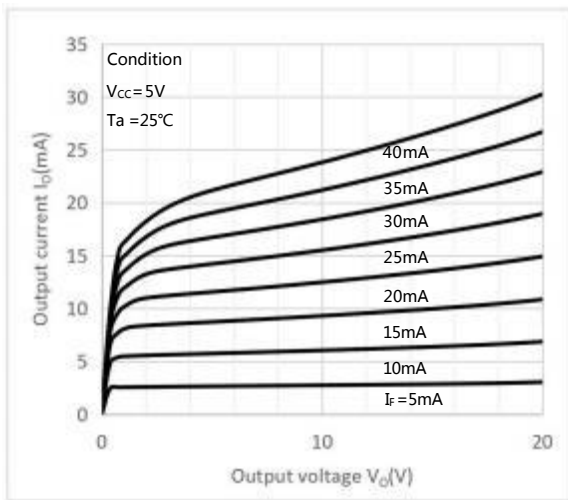

Fig.4 High level output voltage vs. Ambient temperature

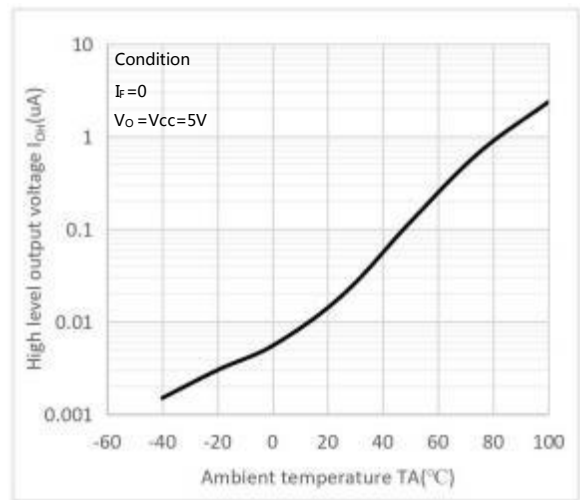

Fig.5 Propagation Delay Time vs. Ambient temperature

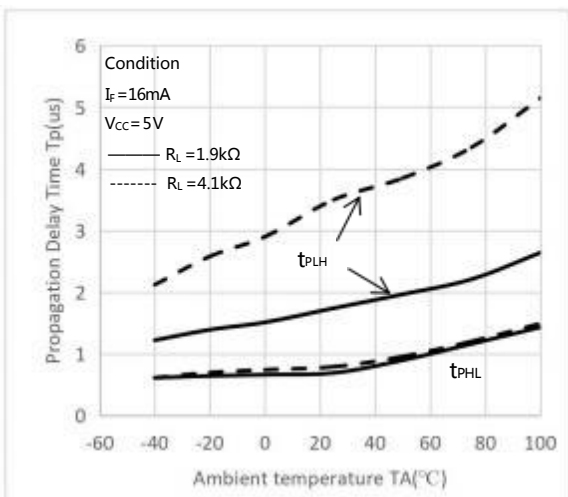
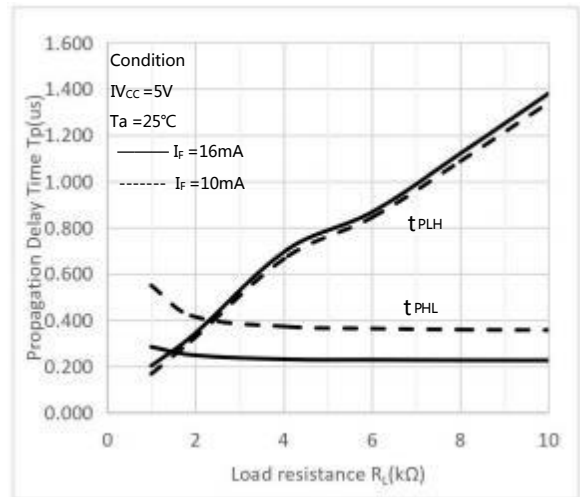
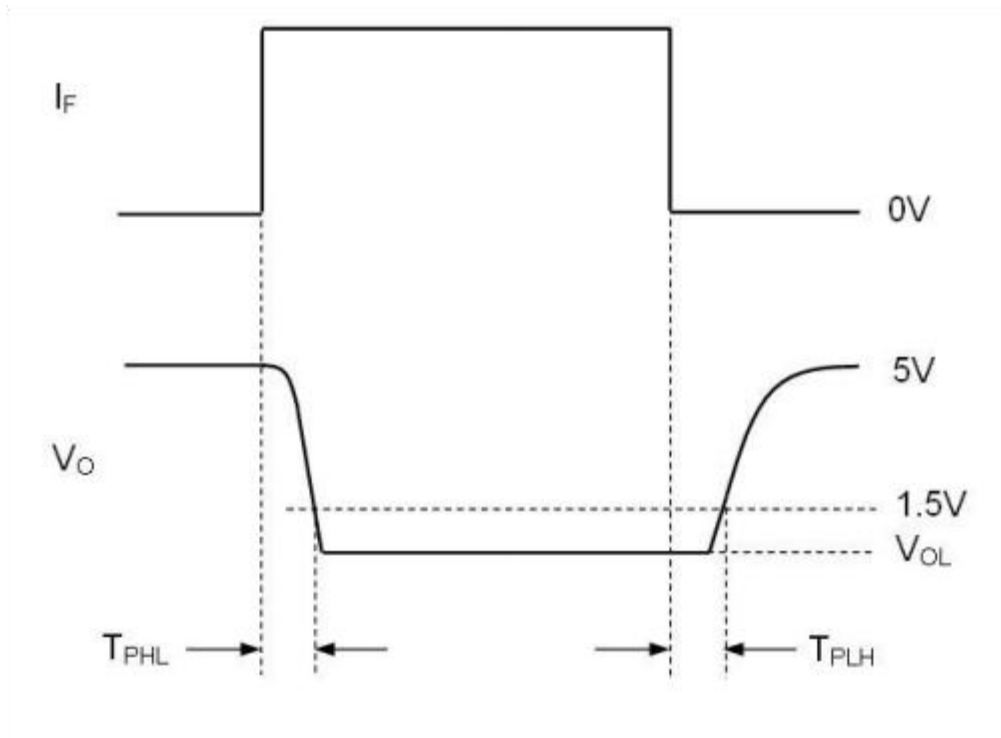
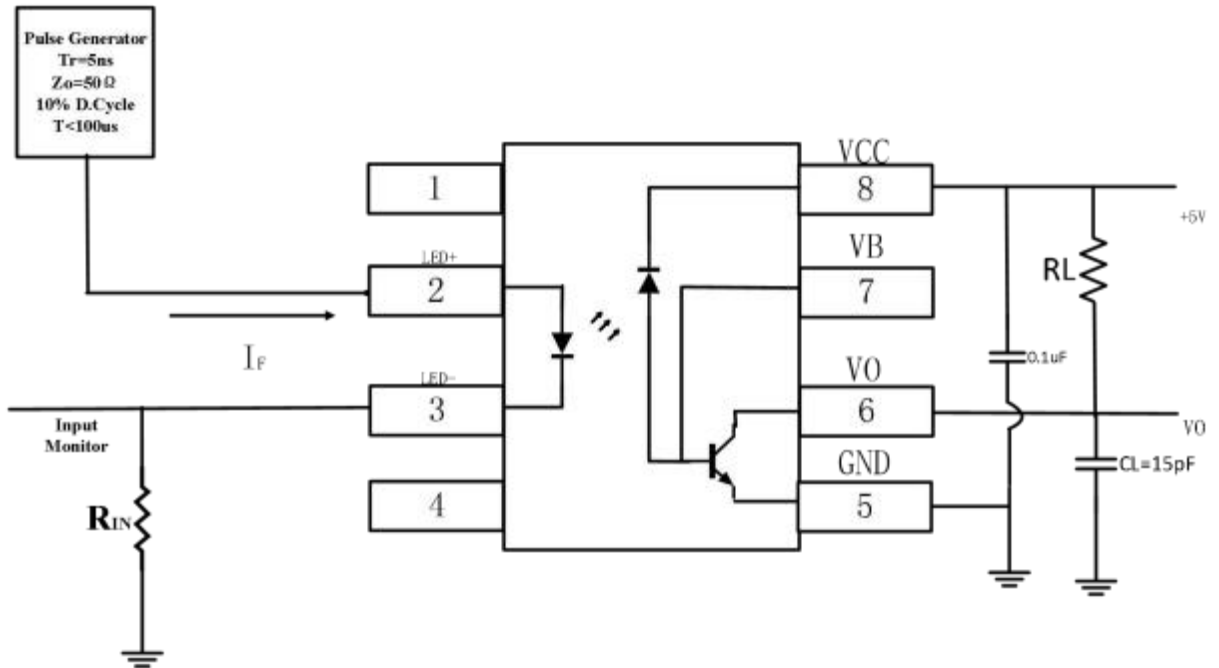

Fig.6 Propagation Delay Time vs. Load resistance





**开关时间测试电路 Witch Time Test Circuit**



**CMR 测试电路 Test Circuit for Common Mode Transient Immunity**

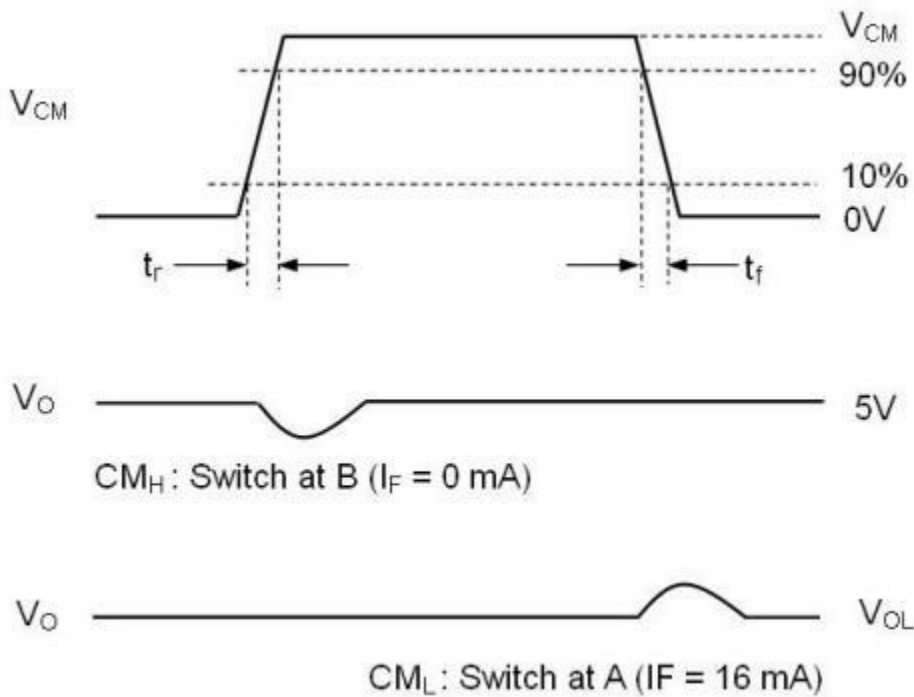
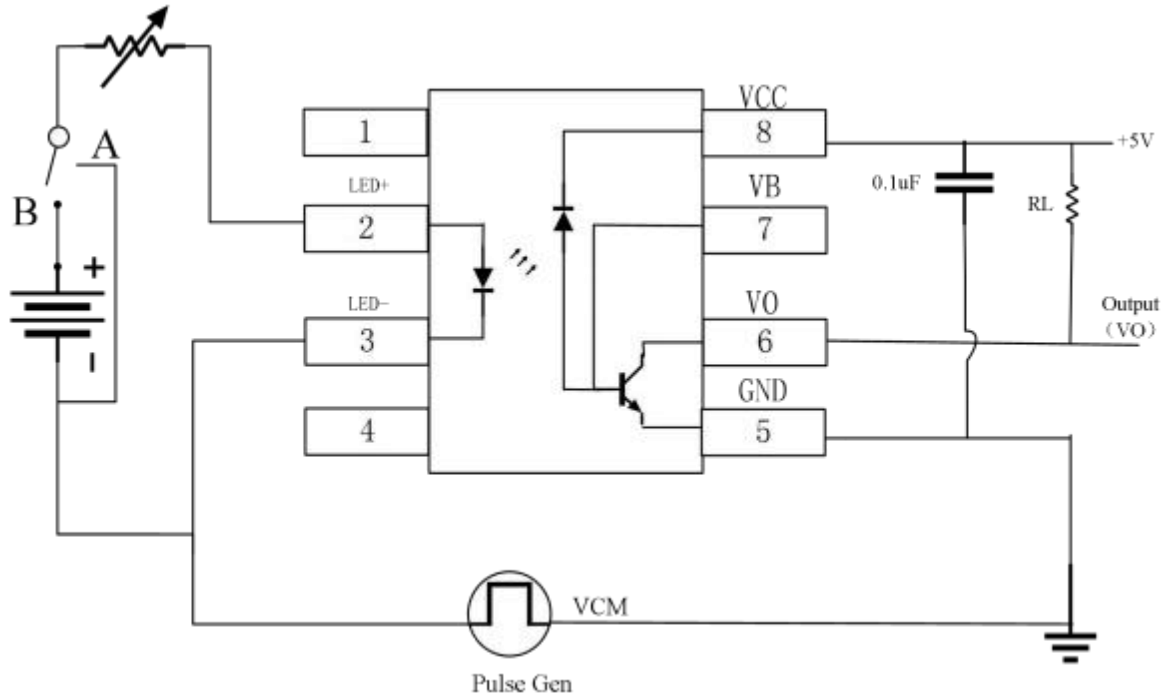

## 外形尺寸 Outline Dimensions

### DIP8

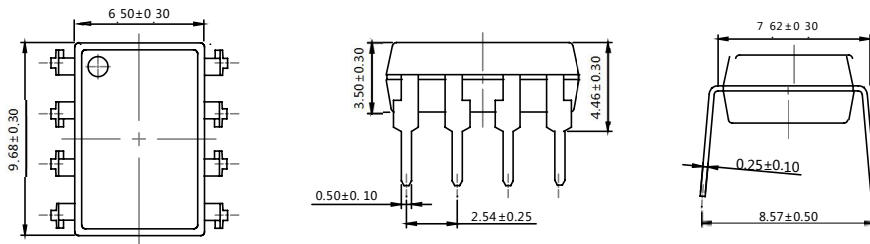

### SMD8

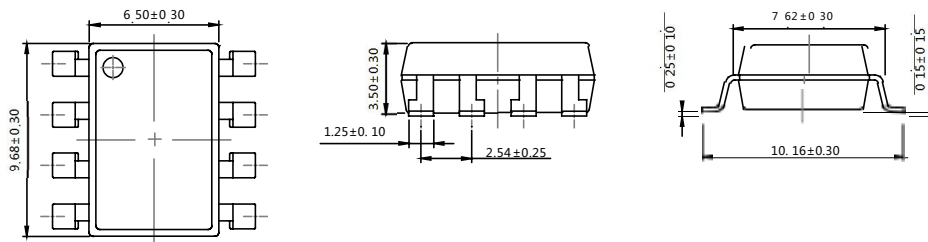

单位 Unit: mm

## 建议焊盘布局 Recommended Pad Layout

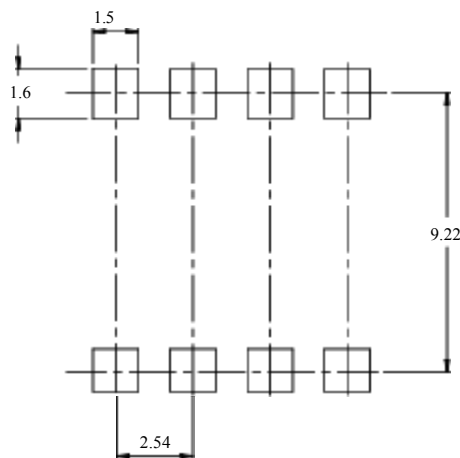

单位 Unit: mm

注：上图为产品正视图。

Note : The picture above is the front view of the product.

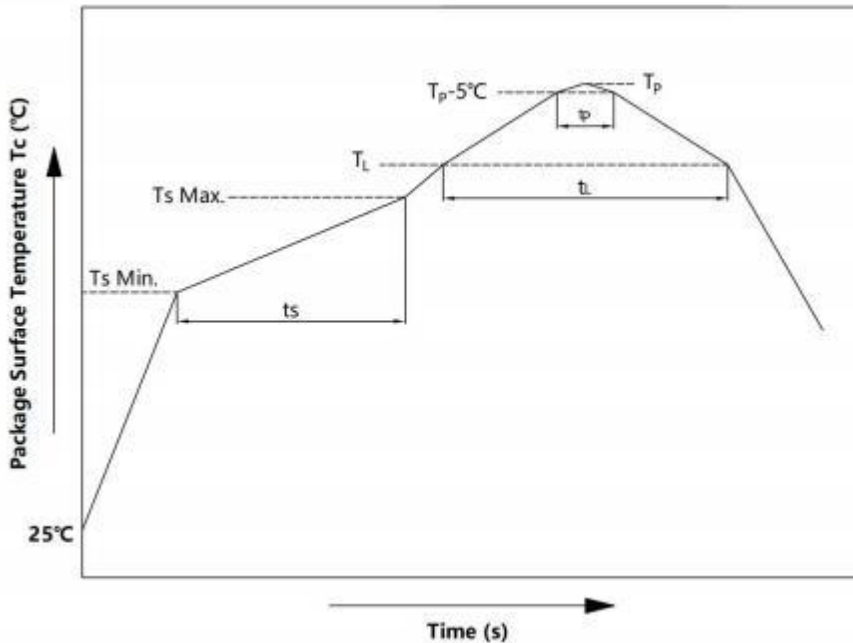
**回流焊温度曲线图 Solder Reflow Profile**

项目 Item	符号 Symbol	最小值 Min.	最大值 Max.	单位 Unit
预热温度 Preheat Temperature	Ts	150	200	°C
预热时间 Preheat Time	ts	60	120	s
升温速率 Ramp-Up Rate (T <sub>L</sub> to T <sub>p</sub> )	-	-	3	°C/s
液相线温度 Liquidus Temperature	T <sub>L</sub>	217		°C
时间高于 T <sub>L</sub> Time Above T <sub>L</sub>	t <sub>L</sub>	60	150	s
峰值温度 Peak Temperature	T <sub>p</sub>	-	260	°C
Tc 在(T <sub>p</sub> -5)和 T <sub>p</sub> 之间的时间 Time During Which Tc Is Between (T <sub>p</sub> -5) and T <sub>p</sub>	t <sub>p</sub>	-	30	s
降温速率 Ramp-down Rate(T <sub>p</sub> to T <sub>L</sub> )	-	-	6	°C/s

注 Note :

建议在所示的温度和时间条件下进行回流焊，最多不能超过三次；

Reflow soldering is recommended at the temperatures and times shown, no more than three times;

### 波峰焊温度曲线图 Wave Soldering Profile

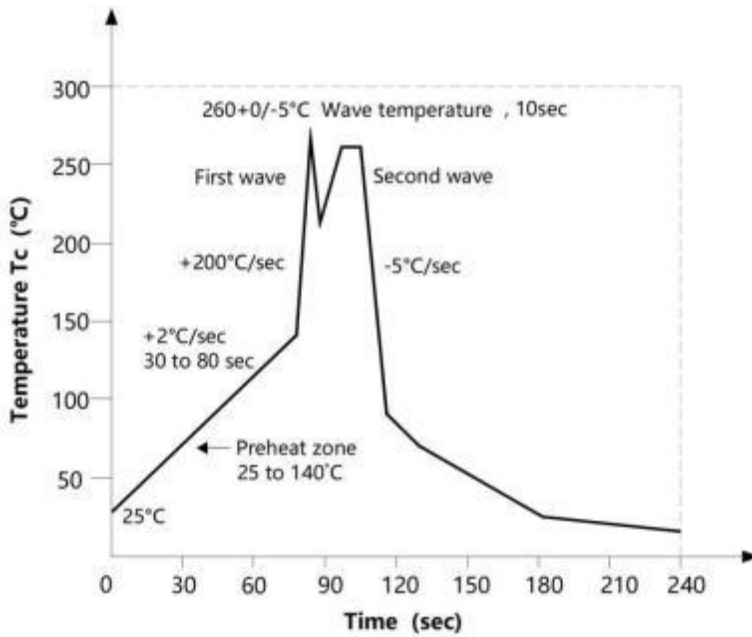

### 手工烙铁焊接 Soldering with hand soldering iron

- A. 手工烙铁焊仅用于产品返修或样品测试；  
Hand soldering iron is only used for product rework or sample testing;
- B. 手工烙铁焊要求：温度  $360^{\circ}\text{C} \pm 5^{\circ}\text{C}$ ，时间  $\leq 3\text{s}$ 。  
Hand soldering iron requirements：Temperature：  $360^{\circ}\text{C} \pm 5^{\circ}\text{C}$ , within 3s.

## 包装 Packing

### ■ 汇总表 Summary table

封装形式	包装方式	盘数量	盒数量	箱数量	静电袋规格	盒规格	箱(双瓦楞)规格	备注
SMD8	卷盘 ( $\phi 330$ mm 蓝盘)	1 千只/盘	2 盘/盒	10 盒/箱	450*390*0.1mm	340*60*340mm	380*360*365 mm	首端空 50 个空格, 末端空 100
DIP8	管装 (500*12*11mm)	45 只/管	50 管/盒	10 盒/箱	不适用	525*128*56mm	535*275*300 mm	每管使用蓝白胶塞, 方向须一致
Package Type	Packing Form	Quantity per Reel	Quantity per Box	Quantity per Carton	Antistatic Bag Specification	Box Specification	Carton Specification	Note
SMD8	Reel( $\phi 330$ mm Blue)	1k pcs/reel	2 reels /box	10 boxes /ctn	450*390*0.1mm	340*60*340 mm	380*360*365 mm	Leave 50 spaces at the beginning and 100 spaces at the end
DIP8	Tube (500*12*11mm)	45pcs /tube	50 tubes/box	10boxes/ctn	NA	525*128*56 mm	535*275*300 mm	Endplug (blue) and Endplug (white) keep the direction

### ■ 条管包装 Tube

- 1) 每箱数量：22500 只。  
Qty/ctn：22500pcs
- 2) 内包装：Inner packing：
  - i. 每条管 45 只。  
45pcs/tube
  - ii. 每盒 50 条管。  
50 tubes/box
- 3) 示意图 Schematic：

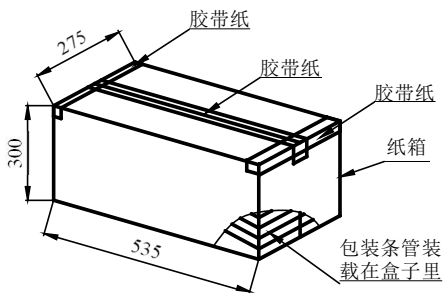

### ■ 编带包装 Tape & Reel

- 1) 每卷数量：1000 只。  
Qty/reel：1000 pcs.
- 2) 每箱数量：20000 只。  
Qty/ctn：20000 pcs.
- 3) 内包装：每盒 2 盘。  
Inner packing：2 reels/box.
- 4) 示意图 Schematic：

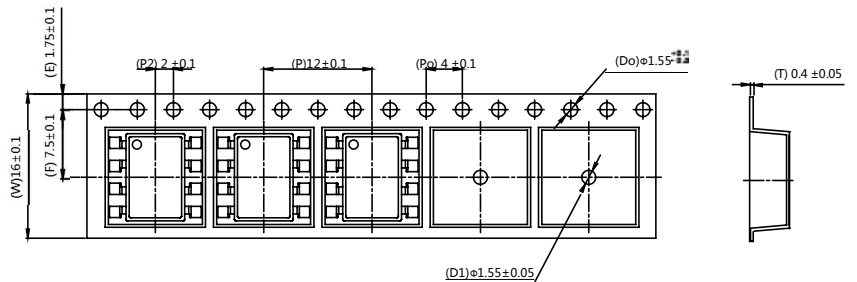

单位 Unit：mm

## 注意 Attention

- 奥特持续不断改进质量、可靠性、功能或设计，保留此文件更改的权利恕不另行通知。  
AOTE continuously improve quality, reliability, function and design. We reserve the right to change this document without prior notice.
- 请遵守产品规格书使用，奥特不对使用时不符合产品规格书条件而导致的质量问题负责。  
Please use in accordance with the product specification. AOTE is not responsible for the quality problems caused by non-compliance with the product specifications.
- 对于需要高可靠性或安全性的设备/装置需求，请联系我们的销售人员。  
For equipment/devices requiring high reliability or safety, please contact our sales representatives.
- 当需要用于任何“特定”应用时，请咨询我们的销售人员。  
When requiring a device for any “specific” application, please contact our sales in advice.
- 如对文件中表述的内容有疑问，欢迎联系我们。  
If you have any questions about the contents of the document, please contact us.