

**Data sheet | Item number: 721-176/001-000**

THT male header; 1.2 x 1.2 mm solder pin; straight; 100% protected against mismatching; Pin spacing 5 mm; 16-pole; light gray

[www.wago.com/721-176/001-000](http://www.wago.com/721-176/001-000)



Subject to changes. Please also observe the further product documentation!

WAGO GmbH & Co. KG  
Hansastr. 27  
32423 Minden  
Phone: +49571 887-0 | Fax: +49571 887-169  
Email: [info.de@wago.com](mailto:info.de@wago.com) | Web: [www.wago.com](http://www.wago.com)

Do you have any questions about our products?  
We are always happy to take your call at +49 (571) 887-44222.

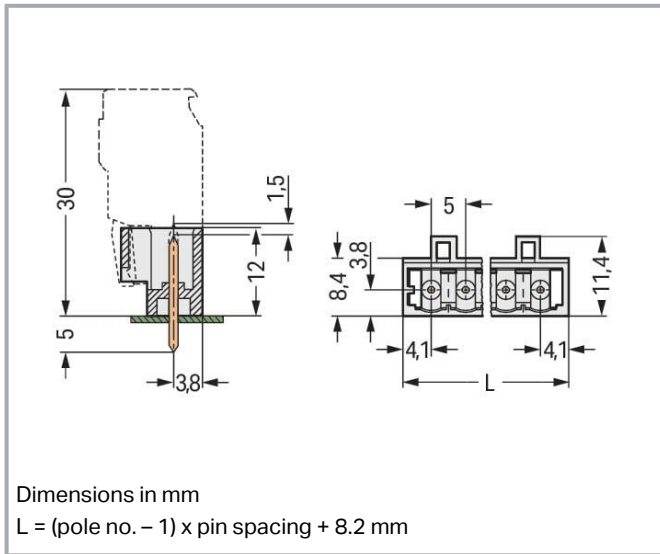

## Item description

- Horizontal or vertical PCB mounting via straight or angled solder pins
- 1.2 x 1.2 mm solder pins allow nominal current up to 16 A, enhancing stability of shorter headers
- 100 % protected against mismatching
- With coding fingers

## Data

### Notes

#### Safety information

The *MCS – MULTI CONNECTION SYSTEM* includes connectors without breaking capacity in accordance with DIN EN 61984. When used as intended, these connectors must not be connected /disconnected when live or under load. When used as intended, these connectors must not be connected/disconnected when live or under load. The circuit design should ensure header pins, which can be touched, are not live when unmated.

#### Variants:

#### Other pole numbers

3.8 mm pin projection for male headers with straight solder pins  
 Gold-plated or partially gold-plated contact surfaces  
 Other versions (or variants) can be requested from WAGO Sales or configured at <https://configurator.wago.com/>.

## Electrical data

Subject to changes. Please also observe the further product documentation!

WAGO GmbH & Co. KG  
 Hansastr. 27  
 32423 Minden  
 Phone: +49571 887-0 | Fax: +49571 887-169  
 Email: [info.de@wago.com](mailto:info.de@wago.com) | Web: [www.wago.com](http://www.wago.com)

Do you have any questions about our products?  
 We are always happy to take your call at +49 (571) 887-44222.



### Ratings per IEC/EN

Ratings per	IEC/EN 60664-1
Nominal voltage (III/3)	250 V
Rated impulse voltage (III/3)	4 kV
Rated voltage (III/2)	320 V
Rated impulse voltage (III/2)	4 kV
Nominal voltage (II/2)	630 V
Rated surge voltage (II/2)	4 kV
Rated current	16 A
Legend (ratings)	(III / 2) $\triangleq$ Overvoltage category III / Pollution degree 2

### Ratings per UL

Approvals per	UL 1059
Rated voltage UL (Use Group B)	300 V
Rated current UL (Use Group B)	15 A
Rated voltage UL (Use Group D)	300 V
Rated current UL (Use Group D)	10 A

### Ratings per UL 1977

Rated voltage (UL 1977)	600 V
Rated current UL 1977	15 A

### Ratings per CSA

Approvals per	CSA
Rated voltage CSA (Use Group B)	300 V
Rated current CSA (Use Group B)	15 A
Rated voltage CSA (Use Group D)	300 V
Rated current CSA (Use Group D)	10 A

### Connection data

Total number of potentials	16
Number of connection types	1
Number of levels	1

Subject to changes. Please also observe the further product documentation!



## Connection 1

Pole number	16
-------------	----

## Physical data

Pin spacing	5 mm / 0.197 inches
Width	83.2 mm / 3.276 inches
Height	17 mm / 0.669 inches
Height from the surface	12 mm / 0.472 inches
Depth	11.4 mm / 0.449 inches
Solder pin length	5 mm
Solder pin dimensions	1.2 x 1.2 mm
Drilled hole diameter with tolerance	1.7 <sup>(+0.1)</sup> mm

## Mechanical Data

Variable coding	Yes
Anti-rotation protection	Yes

## Plug-in connection

Contact type (pluggable connector)	Male connector/plug
Connector (connection type)	for PCB
Mismating protection	Yes
Plugging without loss of pin spacing	No
Mating direction to the PCB	90 °
Locking of plug-in connection	none

## PCB contact

PCB contact	THT
Solder pin arrangement	over the entire male connector (in-line)
Number of solder pins per potential	1

## Material data

Note (material data)	Information on material specifications can be found here
Color	light gray

Subject to changes. Please also observe the further product documentation!



Material group	I
Insulation material	Polyamide (PA66)
Flammability class per UL94	V0
Contact material	Electrolytic copper (E <sub>Cu</sub> )
Contact plating	Tin
Fire load	0.092 MJ
Weight	6.1 g

### Environmental requirements

Limit temperature range	-60 ... +100 °C
Processing temperature	-35 ... +60 °C

### Commercial data

Product Group	3 (Multi Conn. System)
eCl@ss 10.0	27-44-04-02
eCl@ss 9.0	27-44-04-02
ETIM 8.0	EC002637
ETIM 7.0	EC002637
PU (SPU)	50 pcs
Packaging type	box
Country of origin	PL
GTIN	4044918932875
Customs tariff number	85366930000

### Environmental Product Compliance



RoHS Compliance Status	Compliant, No Exemption
------------------------	-------------------------

### Approvals / Certificates

#### General approvals

Logo	Approval	Additional Approval Text	Certificate name
	CB DEKRA Certification B.V.	IEC 61984	NL-39756 /A1
	CSA DEKRA Certification B.V.	C22.2	1466354

Subject to changes. Please also observe the further product documentation!

	<b>KEMA/KEUR</b> DEKRA Certification B.V.	EN 61984	71- 121453
	<b>UL</b> Underwriters Laboratories Inc.	UL 1977	E45171
	<b>UL</b> Underwriters Laboratories Inc.	UL 1059	E45172

**Declarations of conformity and manufacturer's declarations**

Logo	Approval	Additional Approval Text	Certificate name
	<b>Railway</b> WAGO GmbH & Co. KG	-	Railway Ready

**Approvals for marine applications**

Logo	Approval	Additional Approval Text	Certificate name
	<b>ABS</b> American Bureau of Shipping	-	19- HG1869876- PDA
	<b>BV</b> Bureau Veritas S.A.	IEC 60998	11915/DO BV
	<b>DNV</b> DNV GL SE	-	TAE000016Z

**Counterpart**

	<b>Item no.721-116/026-000</b> 1-conductor female connector; CAGE CLAMP®; 2.5 mm²; Pin spacing 5 mm; 16-pole; 100% protected against mismatching; 2,50 mm²; light gray	<a href="http://www.wago.com/721-116/026-000">www.wago.com/721-116/026-000</a>
--	---	--

Subject to changes. Please also observe the further product documentation!

## Optional accessories

### Coding

Coding



Item no.: 231-129

Coding key; snap-on type; light gray

[www.wago.com/231-129](http://www.wago.com/231-129)

### Marking accessories

Marking strip



Item no.: 210-833

Marking strips; 25 m on roll; 6 mm wide; plain; Self-adhesive; white

[www.wago.com/210-833](http://www.wago.com/210-833)



Item no.: 210-834

Marking strips; on reel; 5 mm wide; plain; Self-adhesive; white

[www.wago.com/210-834](http://www.wago.com/210-834)

## Downloads

### Documentation

#### Additional Information

2019 Apr 3

pdf  
2.1 MB

Download

## CAD/CAE-Data

### CAE data

EPLAN Data Portal 721-176/001-000

URL

Download

ZUKEN Portal 721-176/001-000

URL

Download

EPLAN Data Portal 721-176/001-000

URL

Download

### PCB Design

Symbol and Footprint via Ultra Librarian 721-176/001-000

URL

Download

CAX data for your PCB design, consisting of "schematic symbols and PCB footprints", allow easy integration of the WAGO component into your development environment.

#### Supported formats:

- Accel EDA 14 & 15
- Altair
- Altium 6 to current version
- Autodesk Fusion 360

Subject to changes. Please also observe the further product documentation!

WAGO GmbH & Co. KG

Hansastr. 27

32423 Minden

Phone: +49571 887-0 | Fax: +49571 887-169

Email: [info.de@wago.com](mailto:info.de@wago.com) | Web: [www.wago.com](http://www.wago.com)

Do you have any questions about our products?

We are always happy to take your call at +49 (571) 887-44222.



- Cadence Allegro
- DesignSpark
- Eagle Libraries
- KiCad
- Mentor Graphics
- BoardStation
- Mentor Graphics Design Architect
- Mentor Graphics Design
- Expedition 99 and 2000
- OrCAD 9.X PCB and Capture
- PADS PowerPCB 3, 3.5, 4.X, and 5.X
- PADS PowerPCB and PowerLogic 3.0
- PCAD 2000, 2001, 2002, 2004, and 2006
- Pulsonix 8.5 or newer
- STL
- 3D STEP
- TARGET 3001!
- View Logic ViewDraw
- Quadcept
- Zuken CadStar 3 and 4
- Zuken CR-5000 and CR-8000
- Zuken eCADSTAR 2020 and 2021Zuken CR-5000 and CR-8000

PCB Component Libraries (EDA), PCB CAD Library Ultra Librarian

---

Symbol and Footprint via SamacSys 721-176/001-000

[URL](#)

[Download](#)

CAx data for your PCB design, consisting of "schematic symbols and PCB footprints", allow easy integration of the WAGO component into your development environment.

Supported formats:

- 3D (stp)
- Altium
- CADSTAR
- Capture
- CircuitStudio
- CR-5000
- CR-8000
- DEHDL

Subject to changes. Please also observe the further product documentation!

---

WAGO GmbH & Co. KG

Hansastr. 27

32423 Minden

Phone: +49571 887-0 | Fax: +49571 887-169

Email: [info.de@wago.com](mailto:info.de@wago.com) | Web: [www.wago.com](http://www.wago.com)

Do you have any questions about our products?

We are always happy to take your call at +49 (571) 887-44222.





- DesignSpark PCB
- DesignSpark PCB PRO
- DipTrace
- EAGLE
- Easy-PC
- EasyEDA
- eCADSTAR
- KiCad
- OrCAD\_Allegro16
- PADS
- Proteus
- Pulsonix
- Quadcept
- SOLIDWORKS PCB
- TARGET 3001!
- xDX Designer
- Xpedition

PCB Component Libraries (EDA), PCB CAD Library SamacSys Electronic Component Search Engine

---

#### CAD data

2D/3D Models 721-176/001-000	<a href="#">URL</a>	<a href="#">Download</a>
------------------------------	---------------------	--------------------------

---

#### Asset Administration Shell

Asset Administration Shell 721-176/001-000	<a href="#">URL</a>	<a href="#">Download</a>
--	---------------------	--------------------------

---

### Environmental Product Compliance

#### Compliance Search

Environmental Product Compliance 721-176/001-000 THT male header; 1.2 x 1.2 mm solder pin; straight; 100% protected against mismatching; Pin spacing 5 mm; 16-pole; light gray	<a href="#">URL</a>	<a href="#">Download</a>
---	---------------------	--------------------------

---

### Installation Notes

Subject to changes. Please also observe the further product documentation!

---

WAGO GmbH & Co. KG  
Hansastr. 27  
32423 Minden  
Phone: +49571 887-0 | Fax: +49571 887-169  
Email: [info.de@wago.com](mailto:info.de@wago.com) | Web: [www.wago.com](http://www.wago.com)

Do you have any questions about our products?  
We are always happy to take your call at +49 (571) 887-44222.

### Coding

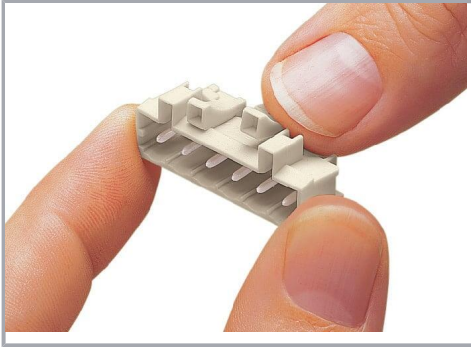

Coding a male header – fitting coding key(s).

### Product family

**MCS MIDI**

[Show all products from the family](#)

Subject to changes. Please also observe the further product documentation!