

**Data sheet | Item number: 283-671**

3-conductor through terminal block; 16 mm<sup>2</sup>; center marking; for DIN-rail 35 x 15 and 35 x 7.5; CAGE CLAMP®; 16,00 mm<sup>2</sup>; gray

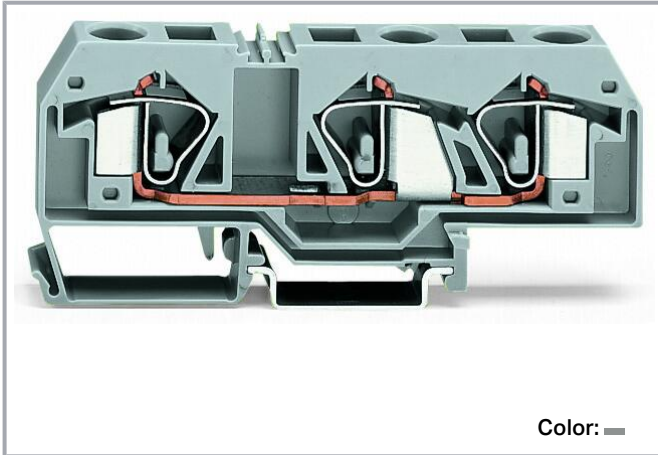

[www.wago.com/283-671](http://www.wago.com/283-671)



Color: —

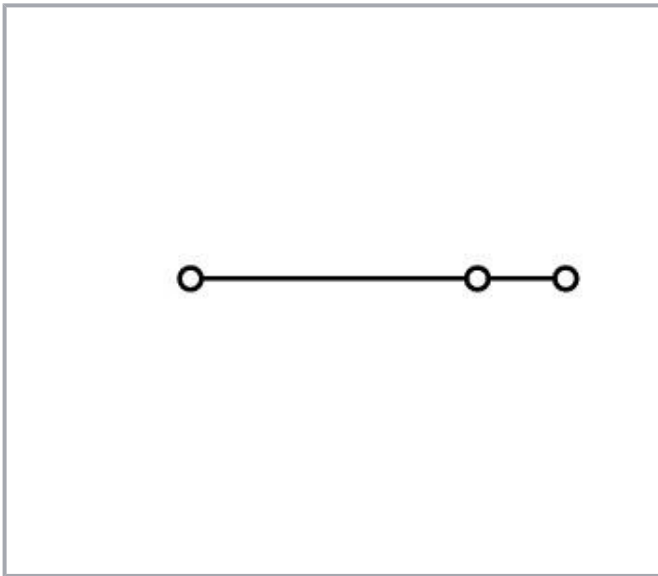
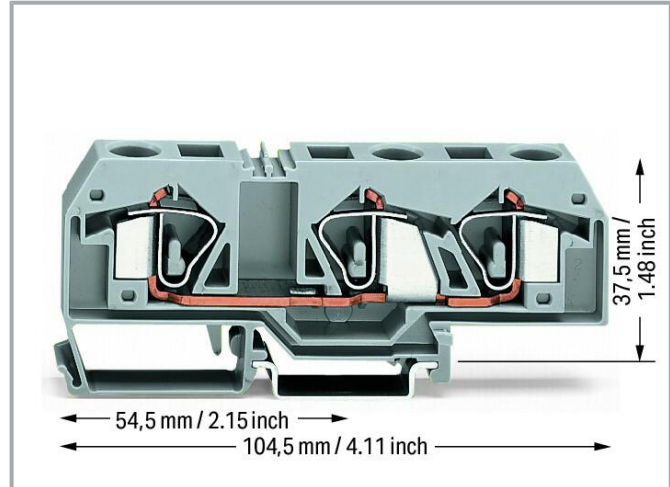

**Data  
Notes**

Safety information

Notice: This terminal block cannot be commoned with adjacent jumpers.

**Electrical data**

Subject to changes. Please also observe the further product documentation!

WAGO GmbH & Co. KG  
Hansastr. 27  
32423 Minden  
Phone: +49571 887-0 | Fax: +49571 887-169  
Email: [info.de@wago.com](mailto:info.de@wago.com) | Web: [www.wago.com](http://www.wago.com)

Do you have any questions about our products?  
We are always happy to take your call at +49 (571) 887-44222.



## Ratings per IEC/EN

Ratings per	IEC/EN 60947-7-1
Nominal voltage (III/3)	800 V
Rated impulse voltage (III/3)	8 kV
Rated current	76 A
Legend (ratings)	(III / 3) $\hat{=}$ Overvoltage category III / Pollution degree 3

## Power Loss

Power loss, per pole (potential)	2.426 W
Rated current $I_N$ for specified power loss	76 A
Resistance value for specified, current-dependent power loss	0 $\Omega$

## Connection data

Connection points	3
Total number of potentials	1
Number of levels	1

## Connection 1

Connection technology	CAGE CLAMP <sup>®</sup>
Actuation type	Operating tool
Connectable conductor materials	Copper
Solid conductor	0.2 ... 16 mm <sup>2</sup> / 24 ... 6 AWG
Fine-stranded conductor	0.2 ... 16 mm <sup>2</sup> / 24 ... 6 AWG
Strip length	16 ... 17 mm / 0.63 ... 0.67 inches
Wiring direction	Front-entry wiring

## Physical data

Width	12 mm / 0.472 inches
Height	104.5 mm / 4.114 inches
Depth from upper-edge of DIN-rail	37.5 mm / 1.476 inches

## Mechanical Data

Mounting type	DIN-35 rail
Marking level	Center marking

Subject to changes. Please also observe the further product documentation!

## Material data

Note (material data)

Information on material specifications can be found here

Color	gray
Material group	I
Insulation material	Polyamide (PA66)
Flammability class per UL94	V0
Fire load	0.619 MJ
Weight	45.3 g

## Environmental requirements

Processing temperature	-35 ... +85 °C
Continuous operating temperature	-60 ... +105 °C

## Commercial data

Product Group	1 (Rail Mounted Terminal Blocks)
eCl@ss 10.0	27-14-11-20
eCl@ss 9.0	27-14-11-20
ETIM 8.0	EC000897
ETIM 7.0	EC000897
PU (SPU)	20 pcs
Packaging type	box
Country of origin	DE
GTIN	4044918543637
Customs tariff number	85369010000

## Environmental Product Compliance



RoHS Compliance Status	Compliant, No Exemption
------------------------	-------------------------

## Approvals / Certificates

### General approvals

Logo	Approval	Additional Approval Text	Certificate name
	CCA DEKRA Certification B.V.	EN 60947	NTR NL 7895



Subject to changes. Please also observe the further product documentation!

	CSA DEKRA Certification B.V.	C22.2 No. 158	1536072
	KEMA/KEUR DEKRA Certification B.V.	EN 60947	71- 120777
	UL UL International Germany GmbH	UL 1059	E45172

## Declarations of conformity and manufacturer's declarations

Logo	Approval	Additional Approval Text	Certificate name
	EU-Declaration of Conformity WAGO GmbH & Co. KG	-	-

## Approvals for marine applications

Logo	Approval	Additional Approval Text	Certificate name
	ABS American Bureau of Shipping	-	20- HG1941090- PDA
	BV Bureau Veritas S.A.	EN 60947	07436/F0 BV
	DNV GL Det Norske Veritas, Germanischer Lloyd	-	TAE00001V2

## Required accessories

## End plate

	Item no.: 283-350 End and intermediate plate; 2.5 mm thick; gray	<a href="http://www.wago.com/283-350">www.wago.com/283-350</a>
--	---	--

Subject to changes. Please also observe the further product documentation!

**Item no.: 283-352**

End and intermediate plate; 2.5 mm thick; orange

[www.wago.com/283-352](http://www.wago.com/283-352)

## Optional accessories

### Cover

#### Cover

**Item no.: 283-400**

Finger guard; touchproof cover protects unused conductor entries; yellow

[www.wago.com/283-400](http://www.wago.com/283-400)

### Mounting

#### Cover carrier

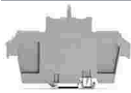
**Item no.: 709-168**

Cover carrier; Type 2; incl. fixing/retaining screws and knurled nut; suitable for 283 to 285 Series rail-mounted terminal blocks; suitable for 279 to 281 Series double- and triple-deck terminal blocks; suitable for 780 to 785, 775, 776 and 777 Series TOPJOB® rail-mounted terminal blocks; suitable for 280 Series sensor and actuator terminal blocks; suitable for 282 Series disconnect/test terminal blocks for transformer circuits; gray

[www.wago.com/709-168](http://www.wago.com/709-168)

#### Cover

**Item no.: 709-154**

Cover; Type 2; suitable for cover carrier, type 2; 1 m long; transparent

[www.wago.com/709-154](http://www.wago.com/709-154)

#### Mounting accessories

**Item no.: 209-106**

Mounting carrier; for isolated mounting on DIN 35 rails; gray

[www.wago.com/209-106](http://www.wago.com/209-106)**Item no.: 249-116**

Screwless end stop; 6 mm wide; for DIN-rail 35 x 15 and 35 x 7.5; gray

[www.wago.com/249-116](http://www.wago.com/249-116)

### Marking accessories

#### Marker

**Item no.: 2009-115/000-002**

WMB-Inline; for Smart Printer; 1500 pieces on roll; stretchable 5 - 5.2 mm; plain; snap-on type; yellow

[www.wago.com/2009-115/000-002](http://www.wago.com/2009-115/000-002)**Item no.: 2009-115/000-007**

WMB-Inline; for Smart Printer; 1500 pieces on roll; stretchable 5 - 5.2 mm; plain; snap-on type; gray

[www.wago.com/2009-115/000-007](http://www.wago.com/2009-115/000-007)**Item no.: 2009-115/000-017**

WMB-Inline; for Smart Printer; 1500 pieces on roll; stretchable 5 - 5.2 mm; plain; snap-on type; light green

[www.wago.com/2009-115/000-017](http://www.wago.com/2009-115/000-017)

Subject to changes. Please also observe the further product documentation!

WAGO GmbH &amp; Co. KG

Hansastr. 27











32423 Minden

Phone: +49571 887-0 | Fax: +49571 887-169

Email: [info.de@wago.com](mailto:info.de@wago.com) | Web: [www.wago.com](http://www.wago.com)

Do you have any questions about our products?

We are always happy to take your call at +49 (571) 887-44222.

	<p><b>Item no.: 2009-115/000-023</b> WMB-Inline; for Smart Printer; 1500 pieces on roll; stretchable 5 - 5.2 mm; plain; snap-on type; green</p>	<p><a href="http://www.wago.com/2009-115/000-023">www.wago.com/2009-115/000-023</a></p>
	<p><b>Item no.: 2009-115/000-024</b> WMB-Inline; for Smart Printer; 1500 pieces on roll; stretchable 5 - 5.2 mm; plain; snap-on type; violet</p>	<p><a href="http://www.wago.com/2009-115/000-024">www.wago.com/2009-115/000-024</a></p>
	<p><b>Item no.: 2009-115</b> WMB-Inline; for Smart Printer; 1500 pieces on roll; stretchable 5 - 5.2 mm; plain; snap-on type; white</p>	<p><a href="http://www.wago.com/2009-115">www.wago.com/2009-115</a></p>
	<p><b>Item no.: 793-5501/000-007</b> WMB marking card; as card; for terminal block width 5 - 17.5 mm; stretchable 5 - 5.2 mm; plain; snap-on type; gray</p>	<p><a href="http://www.wago.com/793-5501/000-007">www.wago.com/793-5501/000-007</a></p>
	<p><b>Item no.: 793-5501/000-012</b> WMB marking card; as card; for terminal block width 5 - 17.5 mm; stretchable 5 - 5.2 mm; plain; snap-on type; orange</p>	<p><a href="http://www.wago.com/793-5501/000-012">www.wago.com/793-5501/000-012</a></p>
	<p><b>Item no.: 793-5501/000-017</b> WMB marking card; as card; for terminal block width 5 - 17.5 mm; stretchable 5 - 5.2 mm; plain; snap-on type; light green</p>	<p><a href="http://www.wago.com/793-5501/000-017">www.wago.com/793-5501/000-017</a></p>
	<p><b>Item no.: 793-5501/000-023</b> WMB marking card; as card; for terminal block width 5 - 17.5 mm; stretchable 5 - 5.2 mm; plain; snap-on type; green</p>	<p><a href="http://www.wago.com/793-5501/000-023">www.wago.com/793-5501/000-023</a></p>
	<p><b>Item no.: 793-5501/000-024</b> WMB marking card; as card; for terminal block width 5 - 17.5 mm; stretchable 5 - 5.2 mm; plain; snap-on type; violet</p>	<p><a href="http://www.wago.com/793-5501/000-024">www.wago.com/793-5501/000-024</a></p>
	<p><b>Item no.: 793-501/000-002</b> WMB marking card; as card; not stretchable; plain; snap-on type; yellow</p>	<p><a href="http://www.wago.com/793-501/000-002">www.wago.com/793-501/000-002</a></p>
	<p><b>Item no.: 793-501/000-007</b> WMB marking card; as card; not stretchable; plain; snap-on type; gray</p>	<p><a href="http://www.wago.com/793-501/000-007">www.wago.com/793-501/000-007</a></p>
	<p><b>Item no.: 793-501/000-017</b> WMB marking card; as card; not stretchable; plain; snap-on type; light green</p>	<p><a href="http://www.wago.com/793-501/000-017">www.wago.com/793-501/000-017</a></p>

Subject to changes. Please also observe the further product documentation!



**Item no.: 793-501/000-012**  
WMB marking card; as card; not stretchable; plain; snap-on type; orange

[www.wago.com/793-501/000-012](http://www.wago.com/793-501/000-012)



**Item no.: 793-501/000-023**  
WMB marking card; as card; not stretchable; plain; snap-on type; green

[www.wago.com/793-501/000-023](http://www.wago.com/793-501/000-023)



**Item no.: 793-501/000-006**  
WMB marking card; as card; not stretchable; plain; snap-on type; blue

[www.wago.com/793-501/000-006](http://www.wago.com/793-501/000-006)



**Item no.: 793-501/000-005**  
WMB marking card; as card; not stretchable; plain; snap-on type; red

[www.wago.com/793-501/000-005](http://www.wago.com/793-501/000-005)



**Item no.: 793-501**  
WMB marking card; as card; not stretchable; plain; snap-on type; white

[www.wago.com/793-501](http://www.wago.com/793-501)



**Item no.: 793-501/000-024**  
WMB marking card; as card; not stretchable; plain; snap-on type; violet

[www.wago.com/793-501/000-024](http://www.wago.com/793-501/000-024)



**Item no.: 793-5501/000-005**  
WMB marking card; as card; for terminal block width 5 - 17.5 mm; stretchable 5 - 5.2 mm; plain; snap-on type; red

[www.wago.com/793-5501/000-005](http://www.wago.com/793-5501/000-005)

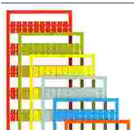

**Item no.: 793-5501/000-002**  
WMB marking card; as card; for terminal block width 5 - 17.5 mm; stretchable 5 - 5.2 mm; plain; snap-on type; yellow

[www.wago.com/793-5501/000-002](http://www.wago.com/793-5501/000-002)

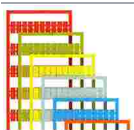

**Item no.: 793-5501/000-006**  
WMB marking card; as card; for terminal block width 5 - 17.5 mm; stretchable 5 - 5.2 mm; plain; snap-on type; blue

[www.wago.com/793-5501/000-006](http://www.wago.com/793-5501/000-006)



**Item no.: 793-5501**  
WMB marking card; as card; for terminal block width 5 - 17.5 mm; stretchable 5 - 5.2 mm; plain; snap-on type; white

[www.wago.com/793-5501](http://www.wago.com/793-5501)



**Item no.: 2009-115/000-012**  
WMB-Inline; for Smart Printer; 1500 pieces on roll; stretchable 5 - 5.2 mm; plain; snap-on type; orange

[www.wago.com/2009-115/000-012](http://www.wago.com/2009-115/000-012)

Subject to changes. Please also observe the further product documentation!

**Item no.:** 2009-115/000-006

WMB-Inline; for Smart Printer; 1500 pieces on roll; stretchable 5 - 5.2 mm; plain; snap-on type; blue

[www.wago.com/2009-115/000-006](http://www.wago.com/2009-115/000-006)

## Group marker carrier

**Item no.:** 249-105

Group marker carrier; gray

[www.wago.com/249-105](http://www.wago.com/249-105)

## Carrier rail

## Mounting accessories

**Item no.:** 210-197

Steel carrier rail; 35 x 15 mm; 1.5 mm thick; 2 m long; slotted; similar to EN 60715; silver-colored

[www.wago.com/210-197](http://www.wago.com/210-197)**Item no.:** 210-198

Copper carrier rail; 35 x 15 mm; 2.3 mm thick; 2 m long; unslotted; according to EN 60715; copper-colored

[www.wago.com/210-198](http://www.wago.com/210-198)**Item no.:** 210-504

Steel carrier rail; 35 x 7.5 mm; 1 mm thick; 2 m long; slotted; galvanized; according to EN 60715; silver-colored

[www.wago.com/210-504](http://www.wago.com/210-504)**Item no.:** 210-505

Steel carrier rail; 35 x 7.5 mm; 1 mm thick; 2 m long; unslotted; galvanized; according to EN 60715; silver-colored

[www.wago.com/210-505](http://www.wago.com/210-505)**Item no.:** 210-506

Steel carrier rail; 35 x 15 mm; 1.5 mm thick; 2 m long; unslotted; galvanized; similar to EN 60715; silver-colored

[www.wago.com/210-506](http://www.wago.com/210-506)**Item no.:** 210-508

Steel carrier rail; 35 x 15 mm; 1.5 mm thick; 2 m long; slotted; galvanized; similar to EN 60715; silver-colored

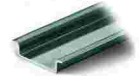
[www.wago.com/210-508](http://www.wago.com/210-508)**Item no.:** 210-113

Steel carrier rail; 35 x 7.5 mm; 1 mm thick; 2 m long; unslotted; according to EN 60715; silver-colored

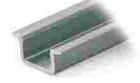
[www.wago.com/210-113](http://www.wago.com/210-113)**Item no.:** 210-118

Steel carrier rail; 35 x 15 mm; 2.3 mm thick; 2 m long; unslotted; according to EN 60715; silver-colored

[www.wago.com/210-118](http://www.wago.com/210-118)**Item no.:** 210-112Steel carrier rail; 35 x 7.5 mm; 1 mm thick; 2 m long; slotted; according to EN 60715; "Hole width 25 mm; silver-colored [www.wago.com/210-112](http://www.wago.com/210-112)**Item no.:** 210-114

Steel carrier rail; 35 x 15 mm; 1.5 mm thick; 2 m long; unslotted; similar to EN 60715; silver-colored

[www.wago.com/210-114](http://www.wago.com/210-114)**Item no.:** 210-115Steel carrier rail; 35 x 7.5 mm; 1 mm thick; 2 m long; slotted; according to EN 60715; "Hole width 18 mm; silver-colored [www.wago.com/210-115](http://www.wago.com/210-115)

Subject to changes. Please also observe the further product documentation!

WAGO GmbH &amp; Co. KG

Hansastr. 27

32423 Minden

Phone: +49571 887-0 | Fax: +49571 887-169

Email: [info.de@wago.com](mailto:info.de@wago.com) | Web: [www.wago.com](http://www.wago.com)

Do you have any questions about our products?

We are always happy to take your call at +49 (571) 887-44222.



**Item no.: 210-196**

Aluminum carrier rail; 35 x 8.2 mm; 1.6 mm thick; 2 m long; unslotted; similar to EN 60715; silver-colored

[www.wago.com/210-196](http://www.wago.com/210-196)**Protective warning marker**

Cover

**Item no.: 283-415**

Protective warning marker; for 5 terminal blocks; with high-voltage symbol, black; yellow

[www.wago.com/283-415](http://www.wago.com/283-415)**Ferrule**

Ferrule

**Item no.: 216-108**Ferrule; Sleeve for 6 mm<sup>2</sup> / AWG 10; uninsulated; electro-tin plated; silver-colored[www.wago.com/216-108](http://www.wago.com/216-108)**Item no.: 216-109**Ferrule; Sleeve for 10 mm<sup>2</sup> / AWG 8; uninsulated; electro-tin plated[www.wago.com/216-109](http://www.wago.com/216-109)**Item no.: 216-286**Ferrule; Sleeve for 2.5 mm<sup>2</sup> / AWG 14; insulated; electro-tin plated; electrolytic copper; gastight crimped; acc. to DIN 46228, Part 4/09.90; blue[www.wago.com/216-286](http://www.wago.com/216-286)**Item no.: 216-287**Ferrule; Sleeve for 4 mm<sup>2</sup> / AWG 12; insulated; electro-tin plated; electrolytic copper; gastight crimped; acc. to DIN 46228, Part 4/09.90; gray[www.wago.com/216-287](http://www.wago.com/216-287)**Item no.: 216-288**Ferrule; Sleeve for 6 mm<sup>2</sup> / AWG 10; insulated; electro-tin plated; electrolytic copper; gastight crimped; acc. to DIN 46228, Part 4/09.90; yellow[www.wago.com/216-288](http://www.wago.com/216-288)**Item no.: 216-289**Ferrule; Sleeve for 10 mm<sup>2</sup> / AWG 8; insulated; electro-tin plated; electrolytic copper; gastight crimped; acc. to DIN 46228, Part 4/09.90; red[www.wago.com/216-289](http://www.wago.com/216-289)**Tool**

Operating tool

**Item no.: 210-721**

Operating tool; Blade: 5.5 x 0.8 mm; with a partially insulated shaft; multicoloured

[www.wago.com/210-721](http://www.wago.com/210-721)**Downloads****Documentation****Bid Text**

283-671 X81 - Datei	2019 Feb 19	xml 3.4 kB	Download
283-671 doc - Datei	2017 Feb 28	doc 25.6 kB	Download

Subject to changes. Please also observe the further product documentation!

WAGO GmbH & Co. KG  
 Hansastr. 27  
 32423 Minden  
 Phone: +49571 887-0 | Fax: +49571 887-169  
 Email: [info.de@wago.com](mailto:info.de@wago.com) | Web: [www.wago.com](http://www.wago.com)

Do you have any questions about our products?  
 We are always happy to take your call at +49 (571) 887-44222.



### Additional Information

pdf  
2.3 MB      Download

### CAD/CAE-Data

#### CAD data

2D/3D Models 283-671      URL      Download

#### CAE data

EPLAN Data Portal 283-671      URL      Download

WSCAD Universe 283-671      URL      Download

ZUKEN Portal 283-671      URL      Download

#### Asset Administration Shell

Asset Administration Shell 283-671      URL      Download

### Environmental Product Compliance

#### Compliance Search

Environmental Product Compliance 283-671      URL      Download

3-conductor through terminal block; 16 mm<sup>2</sup>; center marking; for DIN-rail 35 x 15 and 35 x 7.5; CAGE CLAMP®; 16,00 mm<sup>2</sup>; gray

### Installation Notes

#### Installation

Subject to changes. Please also observe the further product documentation!

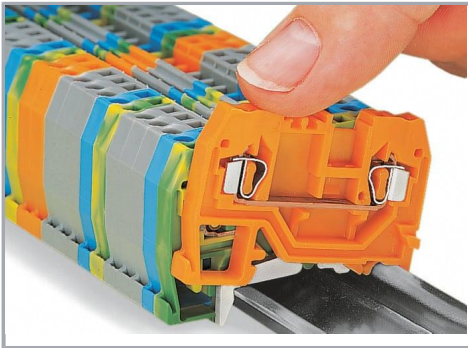

Snapping a terminal block onto the DIN-rail.

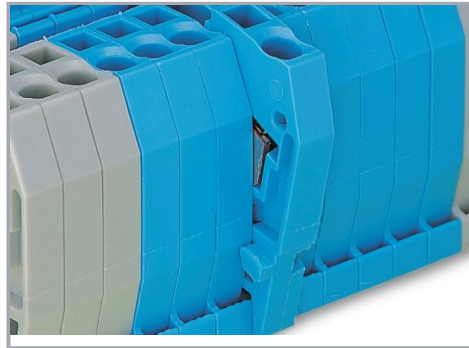

Quick assembly keys prevent reverse mounting.

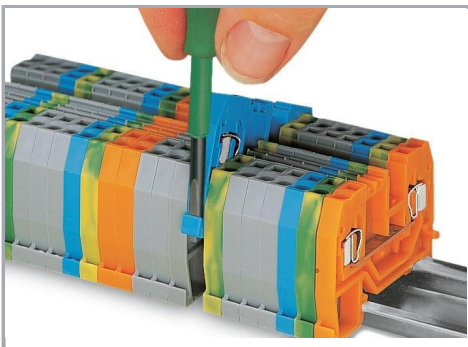

Removing a terminal block from the assembly.

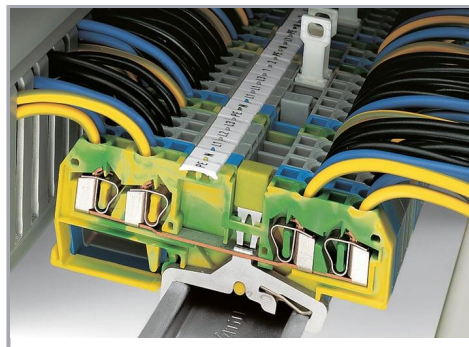

Steel DIN-rails are not suited for PEN (ground and N-conductor) applications per EN 60947-7-2 (VDE 0611, Part 3).

### Conductor termination

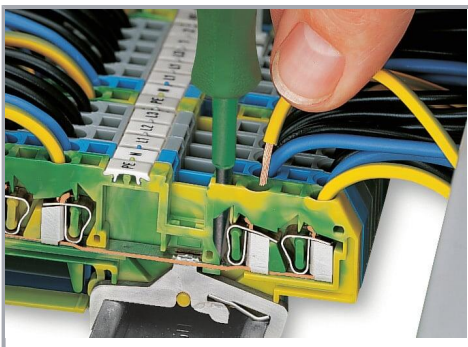

**CAGE CLAMP® connection**  
Inserting a conductor.

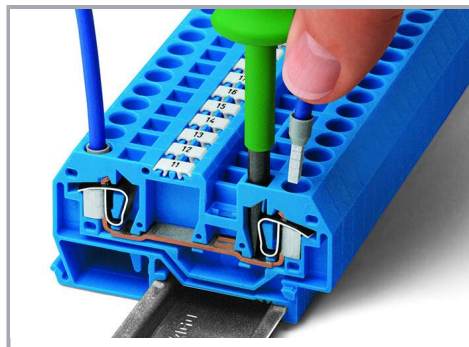

**CAGE CLAMP® connection**  
Inserting a conductor.  
With ferruled conductors, it is necessary to use a terminal block one size larger than the conductor's nominal cross-section.

Subject to changes. Please also observe the further product documentation!

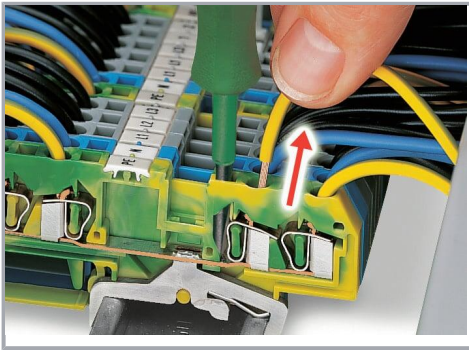

**CAGE CLAMP® connection**  
Removing a solid conductor.

### Cover

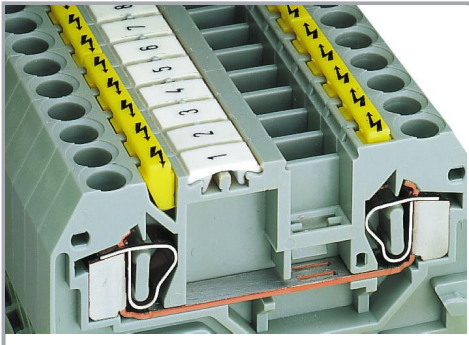

Protective warning markers inserted into the operating slots

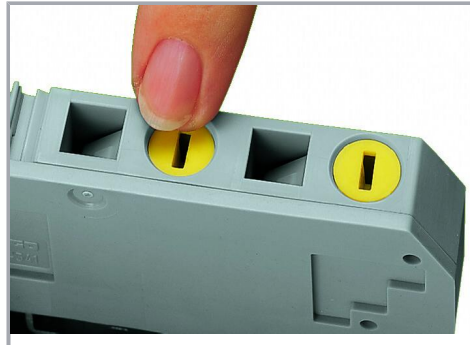

Finger guard seals an unused conductor entry.

### Marking

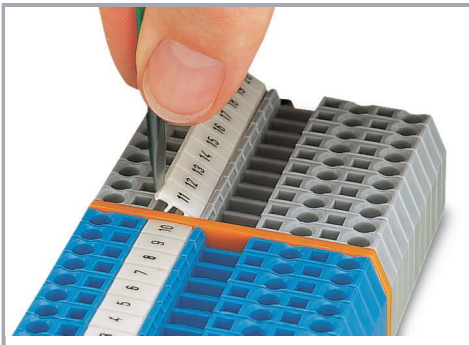

Labeling via WMB Multi Marking System.

Subject to changes. Please also observe the further product documentation!

WAGO GmbH & Co. KG  
Hansastr. 27  
32423 Minden  
Phone: +49571 887-0 | Fax: +49571 887-169  
Email: [info.de@wago.com](mailto:info.de@wago.com) | Web: [www.wago.com](http://www.wago.com)

Do you have any questions about our products?  
We are always happy to take your call at +49 (571) 887-44222.