



EVM3808-LE-00A

5.5V, 3A, Synchronous Step-Down Module Evaluation Board, AEC-Q100 Qualified

DESCRIPTION

The EVM3808-LE-00A evaluation board is designed to demonstrate the capabilities of the MPM3808, an easy-to-use, fully integrated, synchronous step-down power module with a built-in inductor and power MOSFETs. It can achieve up to 3A of continuous output current (I_{OUT}), with excellent load and line regulation.

The constant-on-time (COT) control scheme provides fast transient response and eases loop stabilization. Fault protections include cycle-by-cycle current limiting and thermal shutdown. An open-drain power good (PG) signal indicates when the output voltage (V_{OUT}) exceeds 90% of its nominal voltage.

The MPM3808 is ideal for a wide range of applications, including high-performance digital signal processors (DSPs), advanced driver-assistance system (ADAS) sensors, portable and mobile devices, and other low-power systems with size constraints.

The EVM3808-LE-00A is fully assembled and tested. The MPM3808 is available in a small QFN-15 (3mmx4mmx1.6mm) package with wettable flanks, and requires a minimal number of readily available, standard external components.

PERFORMANCE SUMMARY

Specifications are at $T_A = 25^\circ\text{C}$, unless otherwise noted.

Parameters	Conditions	Value
Input voltage (V_{IN}) range		2.5V to 5.5V
Output voltage (V_{OUT})	$V_{IN} = 2.5\text{V to } 5.5\text{V}$, $I_{OUT} = 0\text{A to } 3\text{A}$	$V_{OUT} = 1.2\text{V}$
Maximum output current (I_{OUT})	$V_{IN} = 2.5\text{V to } 5.5\text{V}$	3A
Typical efficiency	$V_{IN} = 3.3\text{V}$, $V_{OUT} = 1.2\text{V}$, $I_{OUT} = 3\text{A}$	74.98%
Peak efficiency	$V_{IN} = 2.5\text{V}$, $V_{OUT} = 1.2\text{V}$, $I_{OUT} = 300\text{mA}$	90.29%
Switching frequency (f_{sw})		2.4MHz

EVM3808-LE-00A EVALUATION BOARD

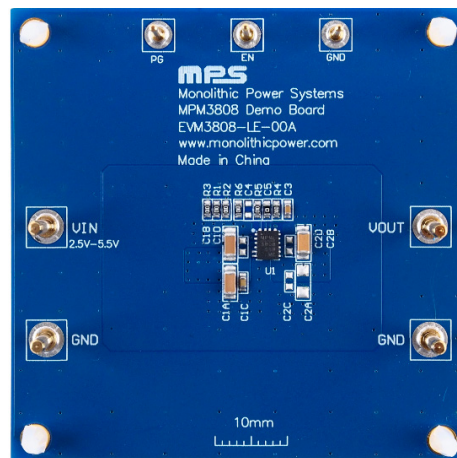

LxWxH (6.3cmx6.3cmx1cm)

Board Number	MPS IC Number
EVM3808-LE-00A	MPM3808GLE-AEC1

QUICK START GUIDE

1. Preset the power supply (V_{IN}) between 2.5V and 5.5V, then turn the power supply off.
2. Set the load current between 0A and 3A. Electronic loads represent a negative impedance to the regulator, and setting a current too high can trigger over-current protection (OCP).
3. If longer cables (>0.5m total) are used between the source and the evaluation board, install a damping capacitor at the input terminals, especially when $V_{IN} \geq 5V$.
4. Connect the power supply terminals to:
 - a. Positive (+): V_{IN}
 - b. Negative (-): GND
5. Connect the load terminals to:
 - a. Positive (+): V_{OUT}
 - b. Negative (-): GND
6. After making the connections, turn the power supply on.
7. To use the enable function, apply a digital input to the EN pin. Drive EN above 0.9V to turn the regulator on; drive EN below 0.65V to turn the regulator off. If the enable function is not used, connect EN directly to V_{IN} .
8. To use the power good (PG) function, connect a probe between the PG and GND pins. PG pulls to GND before the soft start (SS) completes. If V_{FB} rises to be 90% of V_{REF} , PG pulls high through a 100k Ω resistor connected to V_{IN} . If V_{FB} drops to 85% of V_{REF} , the PG pin's voltage (V_{PG}) pulls to GND to indicate an output failure. PG can also be connected to an external voltage source.
9. The external resistor divider sets the output voltage (V_{OUT}).

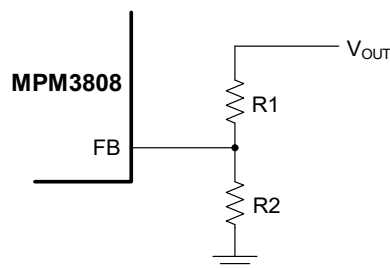

Figure 1: Feedback Divider Network with Adjustable Output

R1 is selected to be 100k Ω . Then R2 can be calculated with Equation (1):

$$R2 = \frac{R1}{\frac{V_{OUT}}{0.6} - 1} \quad (1)$$

Refer to the Application Information section in the MPM3808 datasheet to recalculate the output capacitance when V_{OUT} changes.

10. Figure 2 shows the measurement equipment set-up.

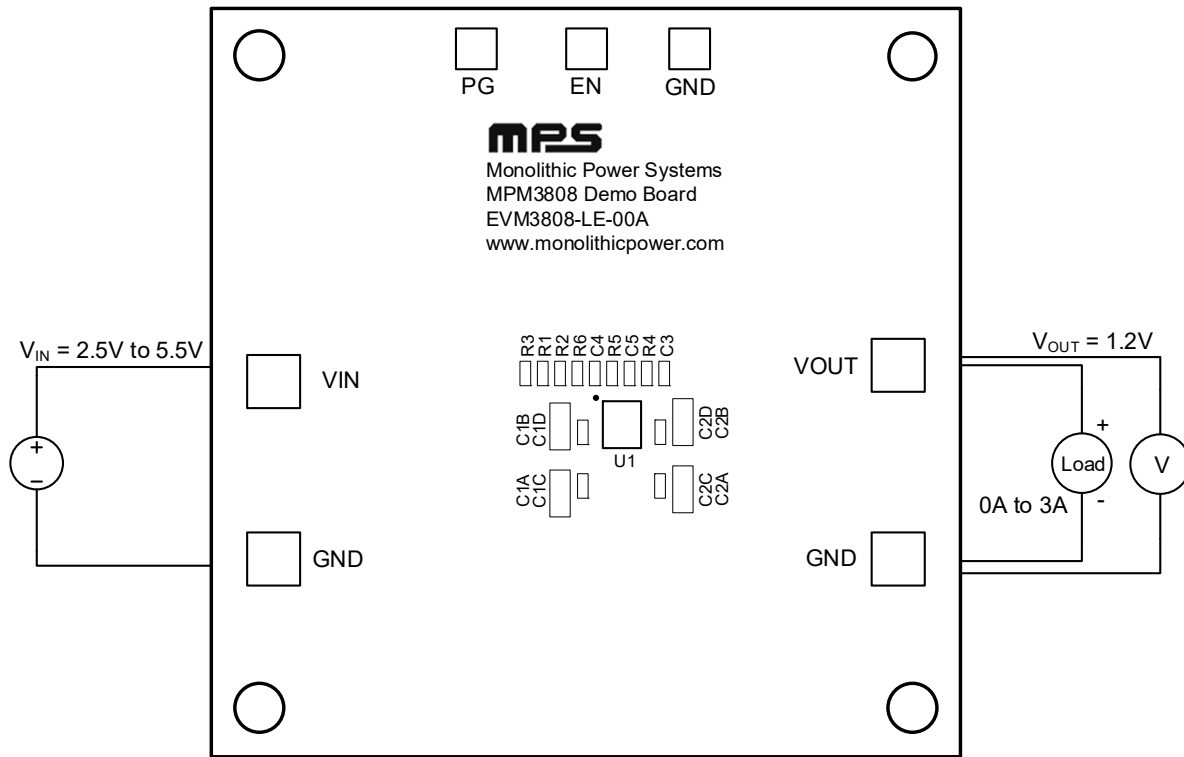

Figure 2: Measurement Equipment Set-Up

EVALUATION BOARD SCHEMATIC

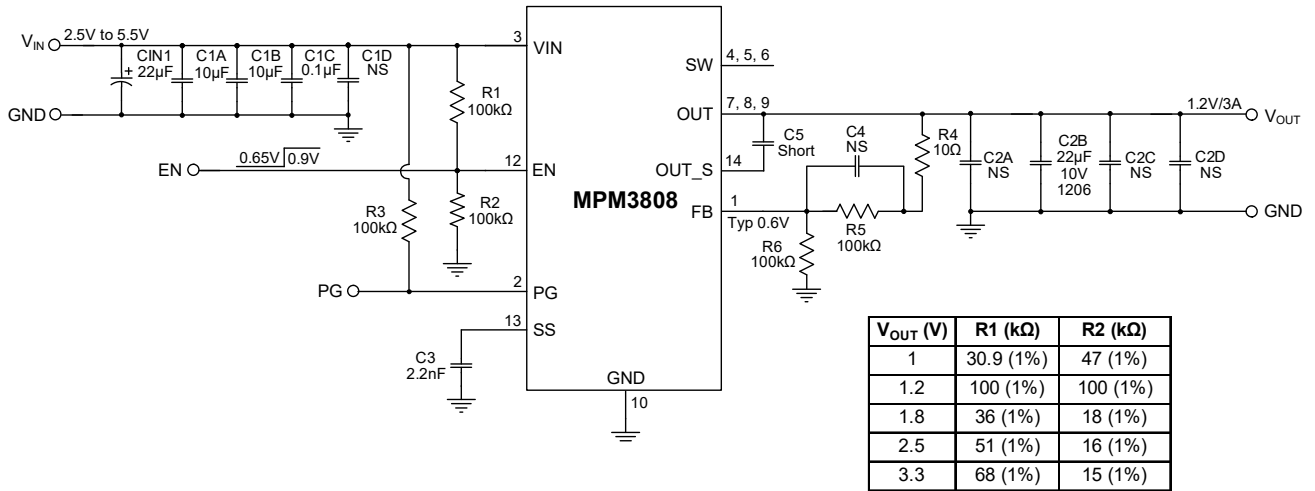
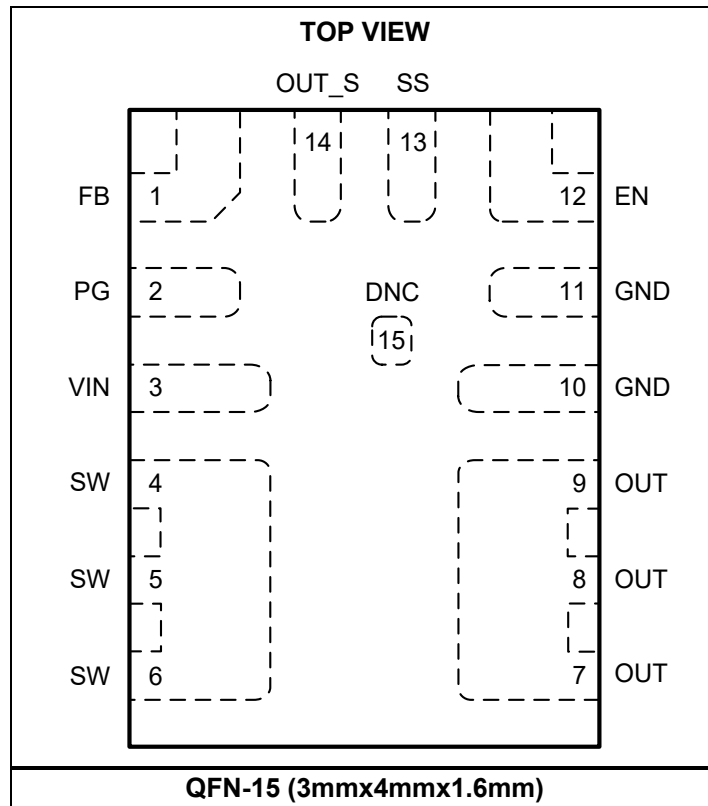

Figure 3: Evaluation Board Schematic

PACKAGE REFERENCE



EVM3808-LE-00A BILL OF MATERIALS

Qty	Ref	Value	Description	Package	Manufacturer	Manufacturer PN
0	C1D, C2A, C2C, C2D	NS				
1	CIN1	22 μ F	Electrical capacitor, 63V	SMD	Jianghai	VTD-63V22
0	C4	NS				
2	C1A, C1B	10 μ F	Ceramic capacitor, 35V, X7R	1206	TDK	C3216X7R1V106K
1	C1C	0.1 μ F	Ceramic capacitor, 16V, X7R	0603	TDK	C1608X7R1C104K
1	C2B	22 μ F	Ceramic capacitor, 10V, X7R	1206	Murata	GRM32ER71A226KE20L
1	C3	2.2nF	Ceramic capacitor, 50V, X7R	0603	TDK	C1608X7R1H222K
1	C5	0 Ω	Film resistor, 5%	0603	Yageo	RC0603JR-070RL
5	R1, R2, R3, R5, R6	100k Ω	Film resistor, 1%	0603	Yageo	RC0603FR-07100KL
1	R4	10 Ω	Film resistor, 1%	0603	Yageo	RC0603FR-0710RL
1	U1	MPM3808	5.5V, 3A, synchronous step-down module, AEC-Q100	QFN-15 (3mmx 4mmx 1.6mm)	MPS	MPM3808GLE-AEC1

EVB TEST RESULTS

Performance curves and waveforms are tested on the evaluation board. $V_{IN} = 3.3V$, $V_{OUT} = 1.2V$, $T_A = 25^\circ C$, unless otherwise noted.

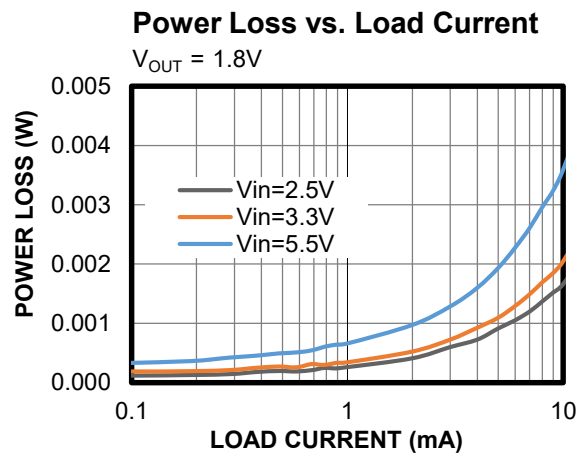
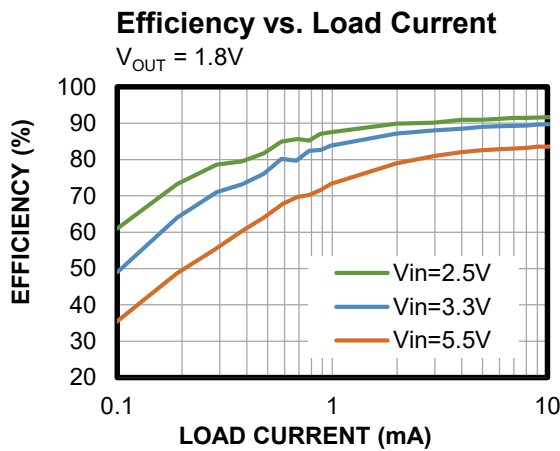
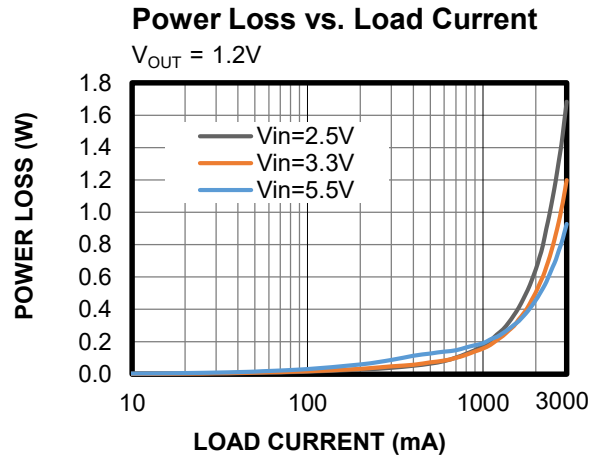
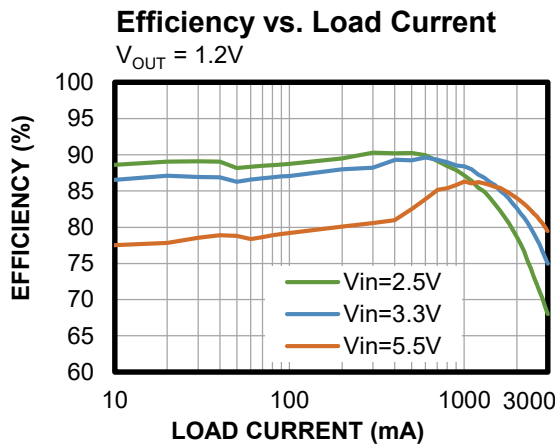
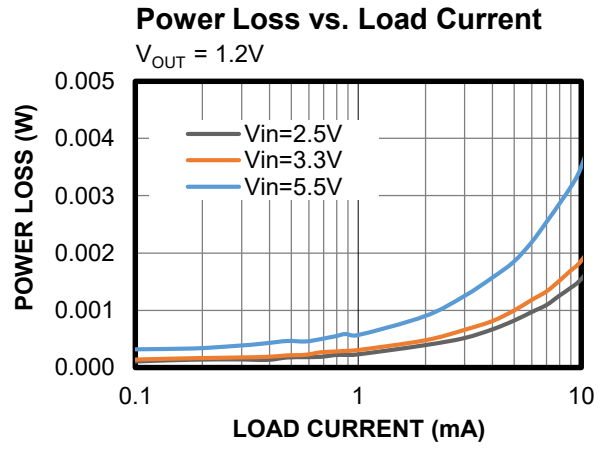
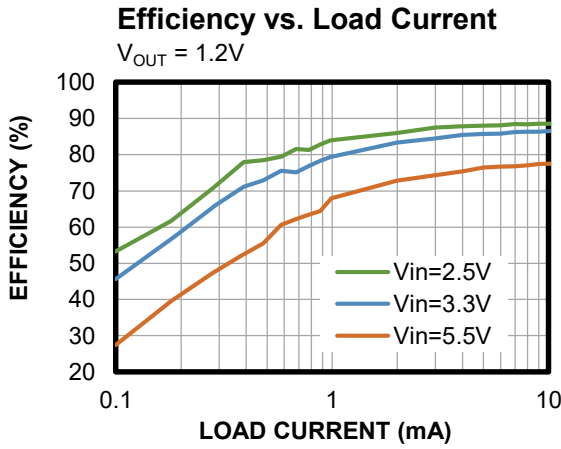

EVB TEST RESULTS (continued)

Performance curves and waveforms are tested on the evaluation board. $V_{IN} = 3.3V$, $V_{OUT} = 1.2V$, $T_A = 25^{\circ}C$, unless otherwise noted.

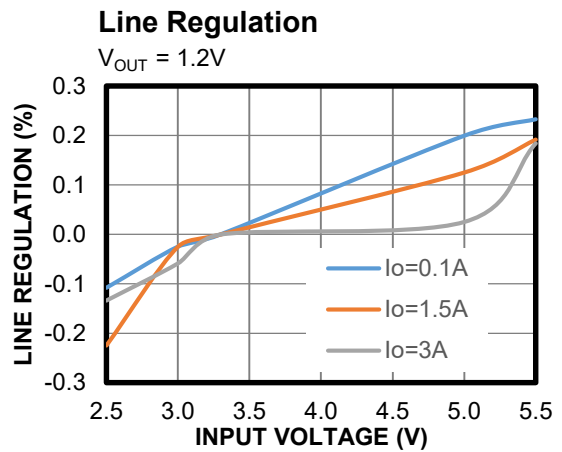
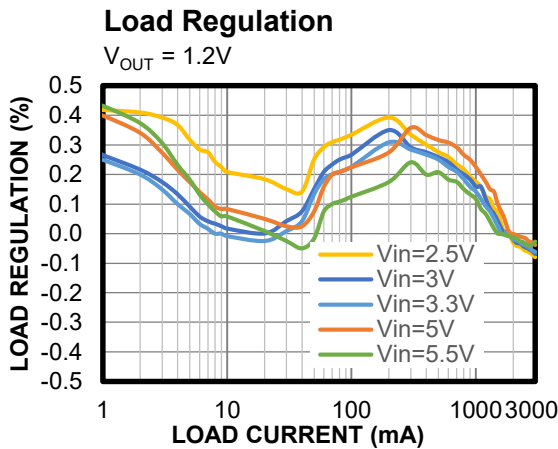
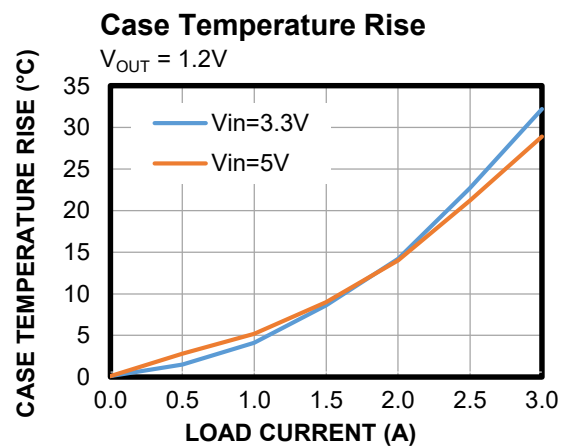
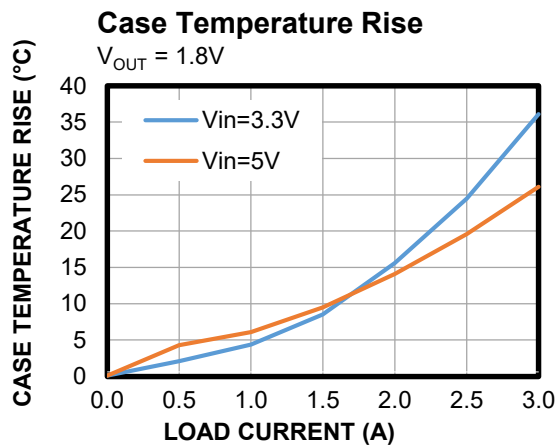
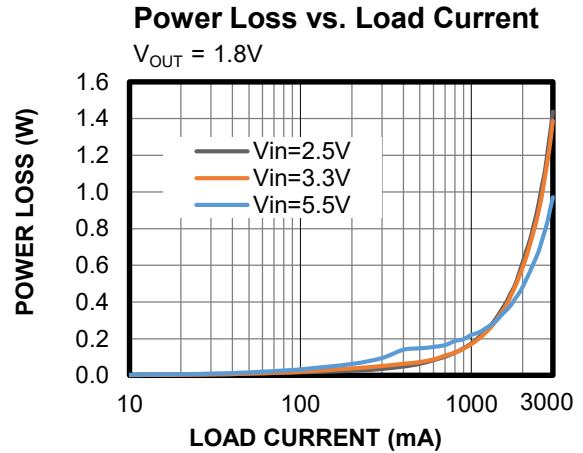
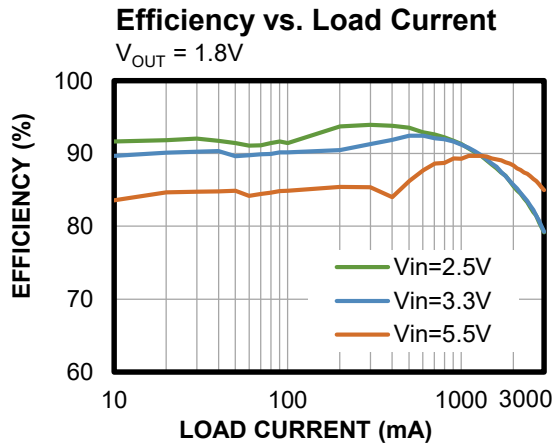

EVB TEST RESULTS *(continued)*

Performance curves and waveforms are tested on the evaluation board. $V_{IN} = 3.3V$, $V_{OUT} = 1.2V$, $T_A = 25^\circ C$, unless otherwise noted.

Thermal Performance

$I_{OUT} = 1.5A$, no forced airflow, $T_{CASE} = 35.2^\circ C$

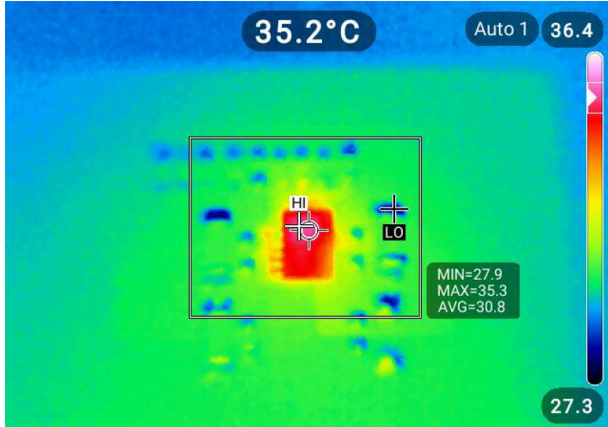

Thermal Performance

$I_{OUT} = 3A$, no forced airflow, $T_{CASE} = 55.6^\circ C$

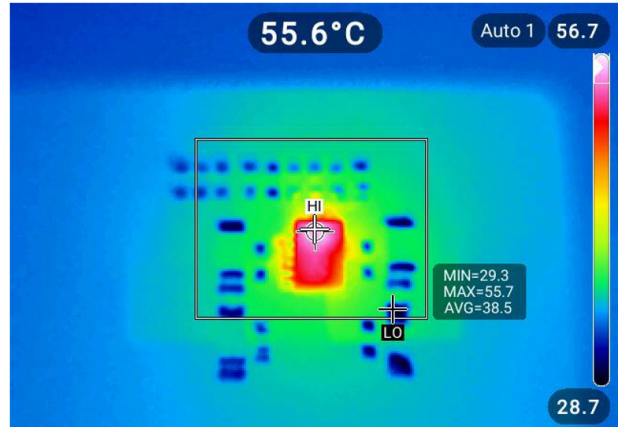

EVB TEST RESULTS (continued)

Performance curves and waveforms are tested on the evaluation board. $V_{IN} = 3.3V$, $V_{OUT} = 1.2V$, $T_A = 25^{\circ}C$, unless otherwise noted.

Steady State

$I_{OUT} = 0A$

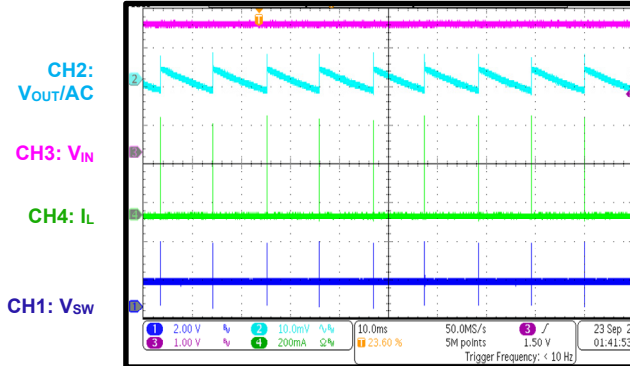

Steady State

$I_{OUT} = 3A$

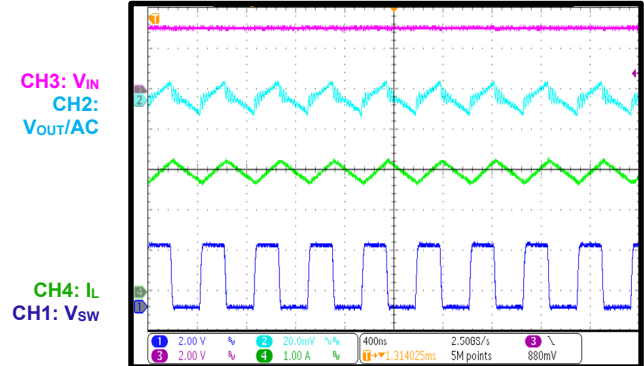

Start-Up through VIN

$I_{OUT} = 0A$

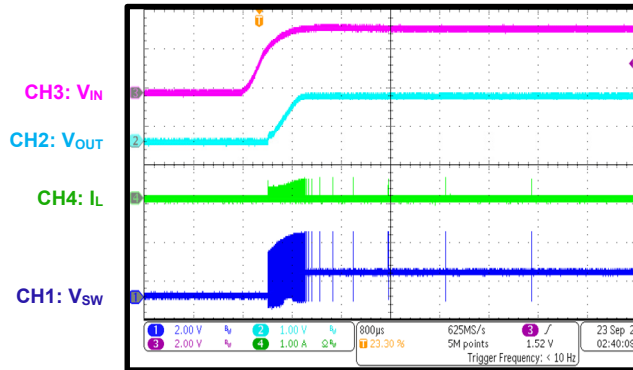

Start-Up through VIN

$I_{OUT} = 3A$

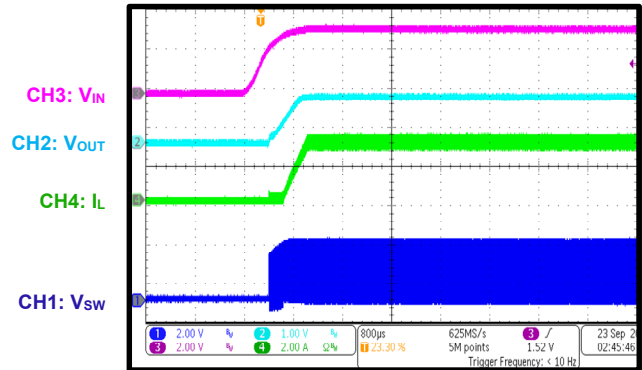

Shutdown through VIN

$I_{OUT} = 0A$

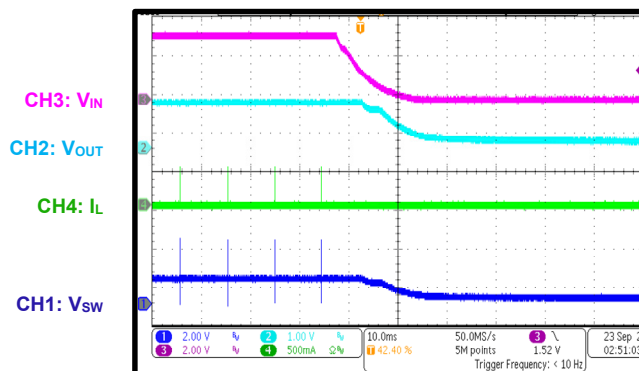

Shutdown through VIN

$I_{OUT} = 3A$

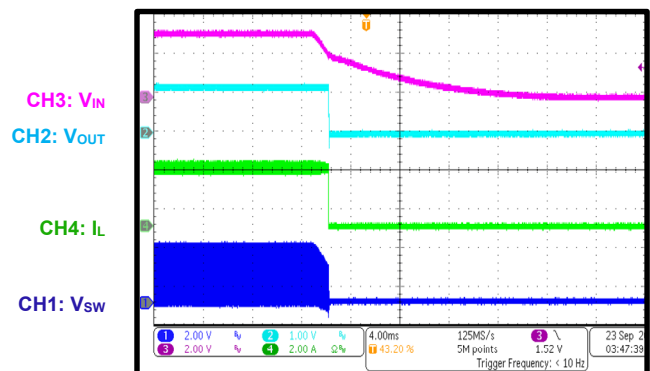

EVB TEST RESULTS (continued)

Performance curves and waveforms are tested on the evaluation board. $V_{IN} = 3.3V$, $V_{OUT} = 1.2V$, $T_A = 25^{\circ}C$, unless otherwise noted.

Start-Up through EN

$I_{OUT} = 0A$

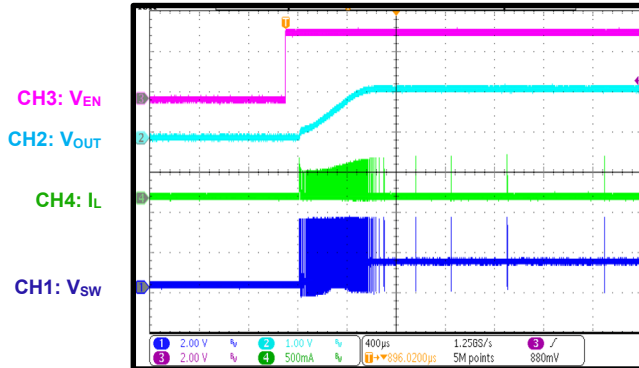

Start-Up through EN

$I_{OUT} = 3A$

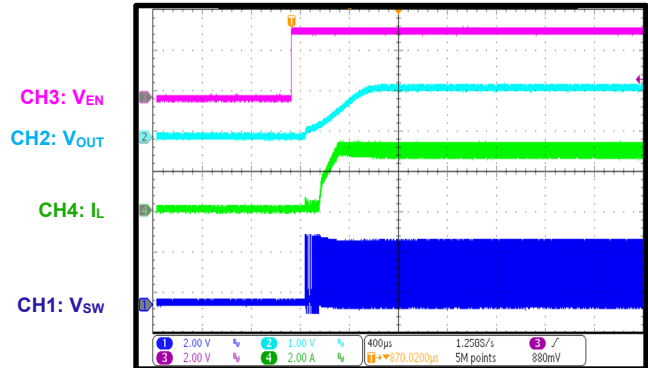

Shutdown through EN

$I_{OUT} = 0A$

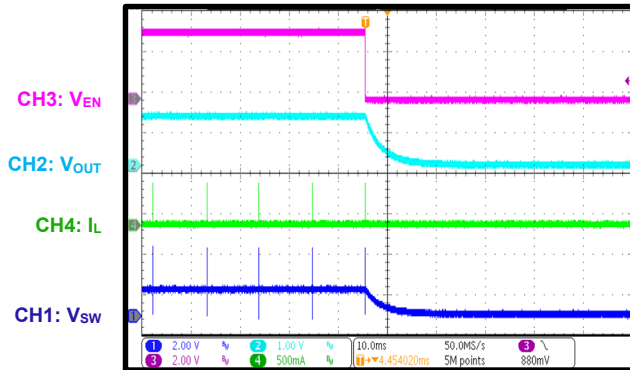

Shutdown through EN

$I_{OUT} = 3A$

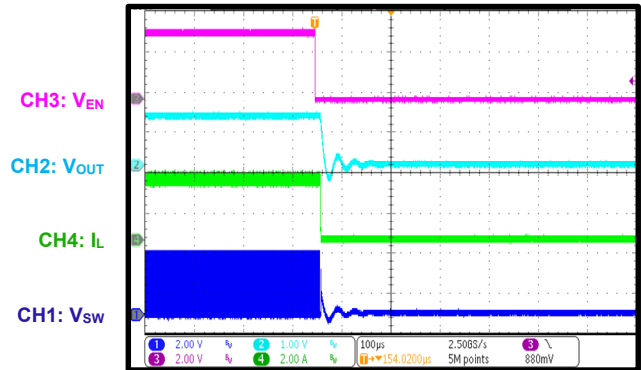

SCP Entry

$I_{OUT} = 0A$

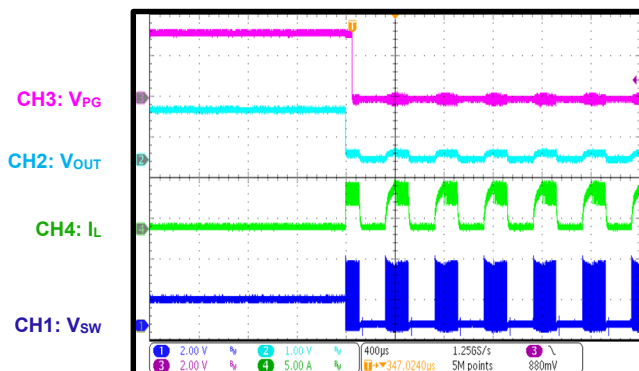

SCP Entry

$I_{OUT} = 3A$

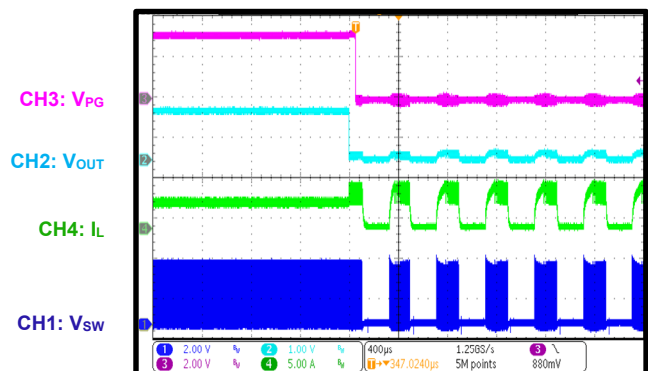

EVB TEST RESULTS (continued)

Performance curves and waveforms are tested on the evaluation board. $V_{IN} = 3.3V$, $V_{OUT} = 1.2V$, $T_A = 25^{\circ}C$, unless otherwise noted.

SCP Recovery

$I_{OUT} = 0A$

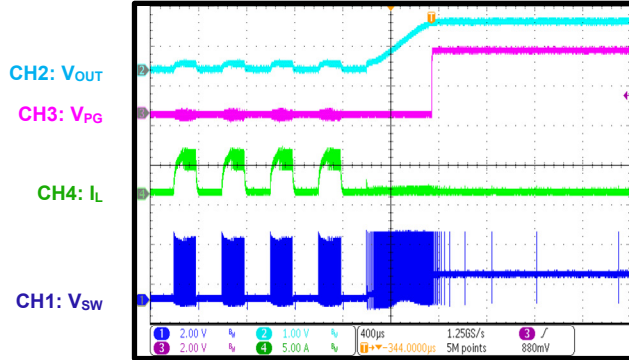

SCP Recovery

$I_{OUT} = 3A$

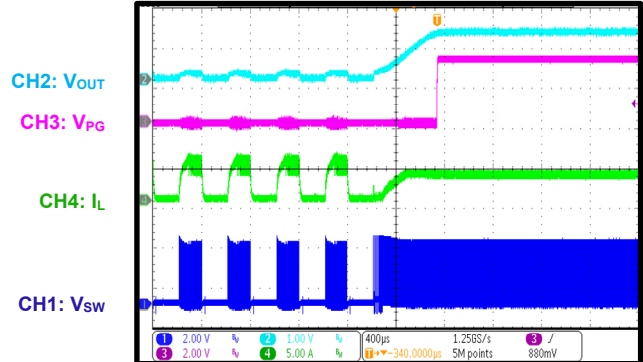

Short Circuit Protection

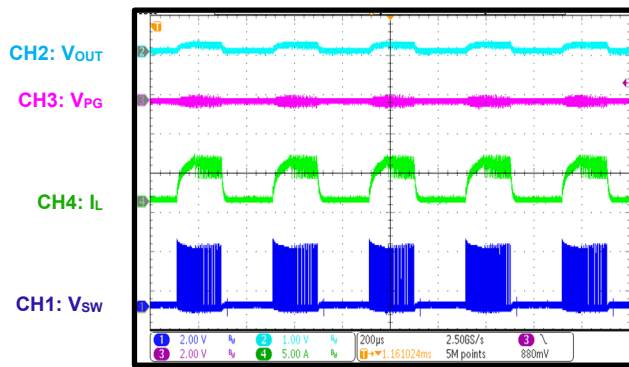

PG Start-Up through VIN

$I_{OUT} = 3A$

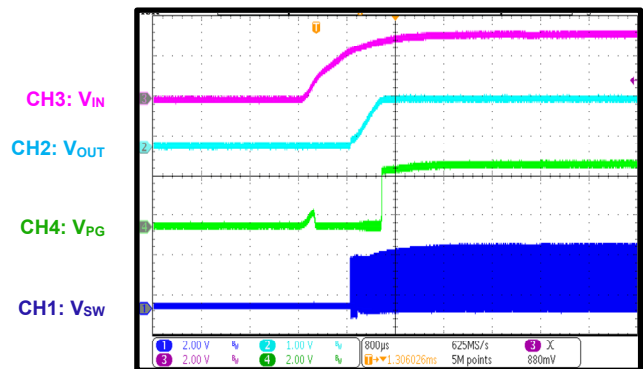

PG Shutdown through VIN

$I_{OUT} = 3A$

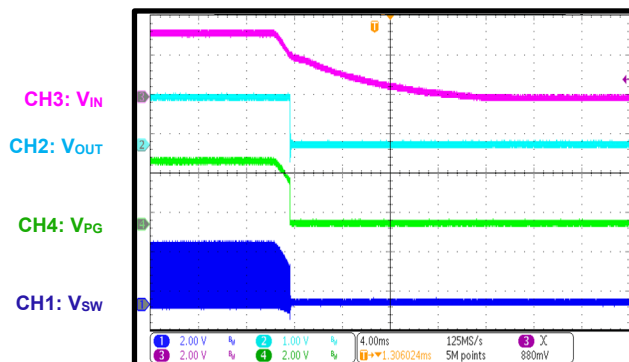

PG Start-Up through EN

$I_{OUT} = 3A$

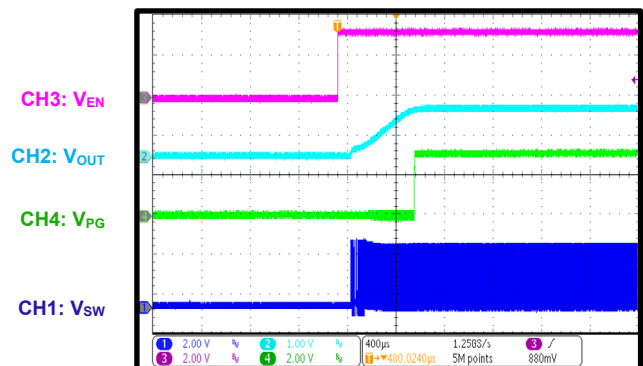

EVB TEST RESULTS *(continued)*

Performance curves and waveforms are tested on the evaluation board. $V_{IN} = 3.3V$, $V_{OUT} = 1.2V$, $T_A = 25^{\circ}C$, unless otherwise noted.

PG Shutdown through EN

$I_{OUT} = 3A$

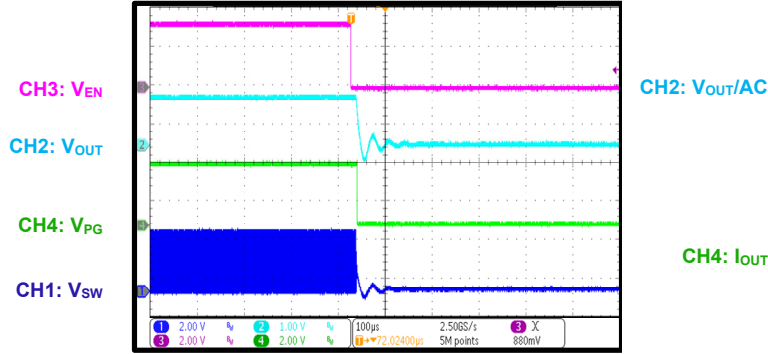

Load Transient

$I_{OUT} = 0A$ to $1.5A$, $1A/\mu s$

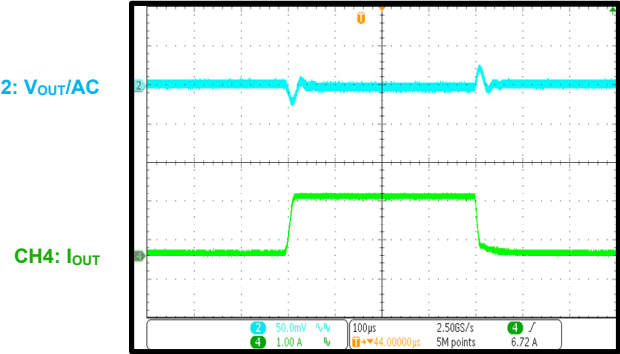

Load Transient

$I_{OUT} = 1.5A$ to $3A$, $1A/\mu s$

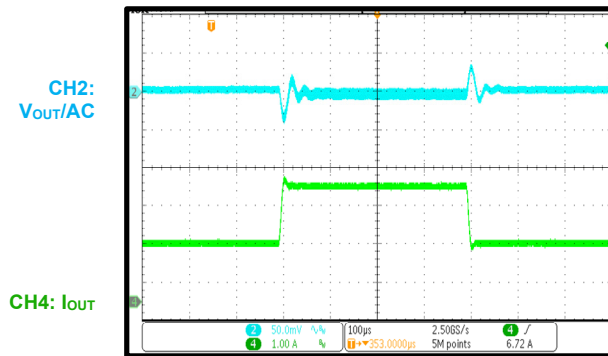

PCB LAYOUT (1)

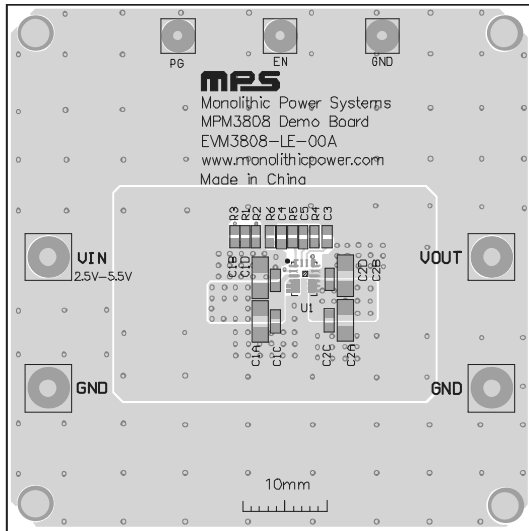

Figure 3: Top Silk and Top Layer

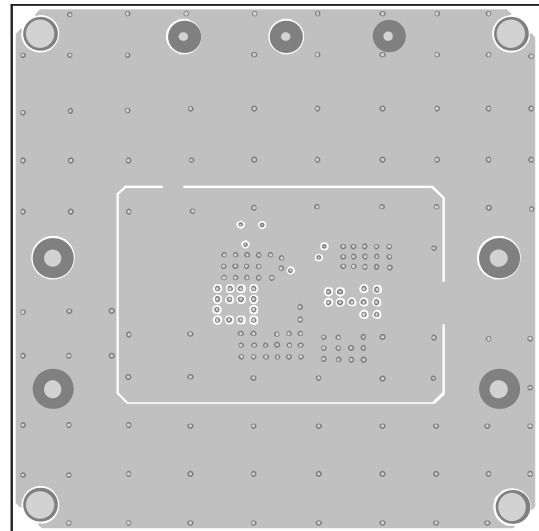

Figure 4: Mid-Layer 1

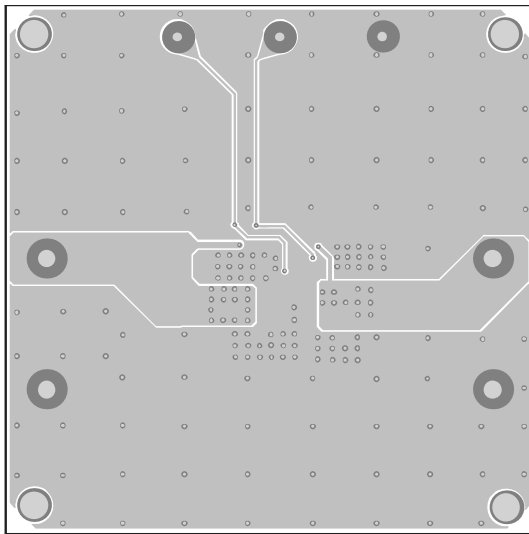

Figure 5: Mid-Layer 2

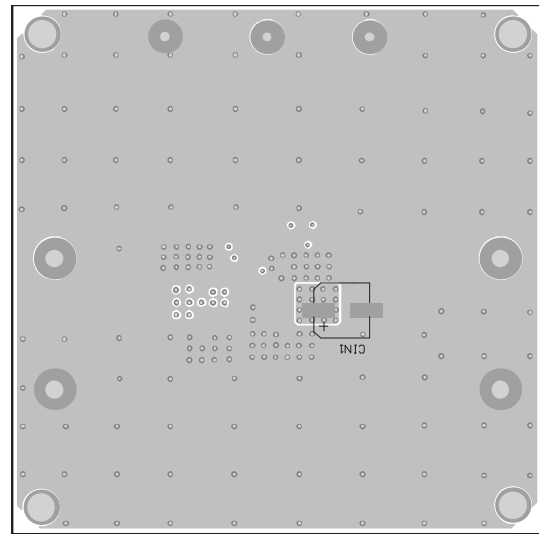

Figure 6: Bottom Layer and Bottom Silk

Note:

- 1) The copper thickness of all layers is 2oz.

REVISION HISTORY

Revision #	Revision Date	Description	Pages Updated
1.0	8/5/2022	Initial Release	-

Notice: The information in this document is subject to change without notice. Please contact MPS for current specifications. Users should warrant and guarantee that third-party Intellectual Property rights are not infringed upon when integrating MPS products into any application. MPS will not assume any legal responsibility for any said applications.