

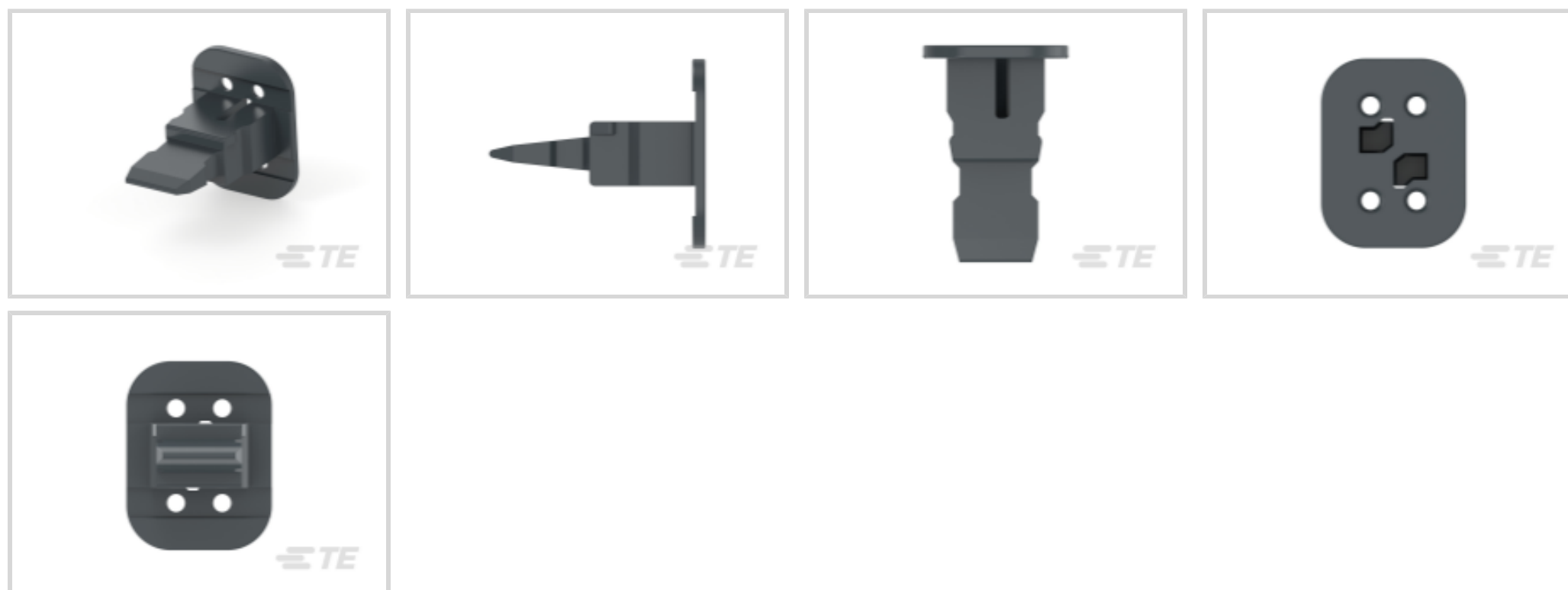

Connectors > Automotive Connectors > Automotive Connector Accessories > Automotive Connector Locks & Position Assurance >

Wedgelocks: DEUTSCH DT



Connector & Contact Retention Accessory Type: **Secondary Lock**

Primary Product Color: **Black**

Primary Product Material: **PBT**

Number of Positions: **4**

Sealable: **No**

[All Wedgelocks: DEUTSCH DT \(51\)](#)

Features

Product Type Features

Connector & Contact Retention Accessory Type	Secondary Lock
Sealable	No

Configuration Features

Number of Positions	4
---------------------	---

Body Features

Primary Product Color	Black
Primary Product Material	PBT

Usage Conditions

Operating Temperature Range	-55 – 125 °C[-67 – 257 °F]
-----------------------------	----------------------------

Industry Standards

UL Flammability Rating	UL 94HB
------------------------	---------

Packaging Features



Packaging Method	Box
------------------	-----

Other

Serviceable	Yes
-------------	-----

Product Compliance

[For compliance documentation, visit the product page on TE.com>](#)

EU RoHS Directive 2011/65/EU	Compliant
EU ELV Directive 2000/53/EC	Compliant
China RoHS 2 Directive MIIT Order No 32, 2016	No Restricted Materials Above Threshold
EU REACH Regulation (EC) No. 1907/2006	Current ECHA Candidate List: JUNE 2023 (235) Candidate List Declared Against: JUNE 2023 (235) Does not contain REACH SVHC
Halogen Content	Low Halogen - Br, Cl, F, I < 900 ppm per homogenous material. Also BFR/CFR/PVC Free
Solder Process Capability	Not reviewed for solder process capability

Product Compliance Disclaimer

This information is provided based on reasonable inquiry of our suppliers and represents our current actual knowledge based on the information they provided. This information is subject to change. The part numbers that TE has identified as EU RoHS compliant have a maximum concentration of 0.1% by weight in homogenous materials for lead, hexavalent chromium, mercury, PBB, PBDE, DBP, BBP, DEHP, DIBP, and 0.01% for cadmium, or qualify for an exemption to these limits as defined in the Annexes of Directive 2011/65/EU (RoHS2). Finished electrical and electronic equipment products will be CE marked as required by Directive 2011/65/EU. Components may not be CE marked. Additionally, the part numbers that TE has identified as EU ELV compliant have a maximum concentration of 0.1% by weight in homogenous materials for lead, hexavalent chromium, and mercury, and 0.01% for cadmium, or qualify for an exemption to these limits as defined in the Annexes of Directive 2000/53/EC (ELV). Regarding the REACH Regulation, the information TE provides on SVHC in articles for this part number is based on the latest European Chemicals Agency (ECHA) 'Guidance on requirements for substances in articles' posted at this URL: <https://echa.europa.eu/guidance-documents/guidance-on-reach>

Compatible Parts



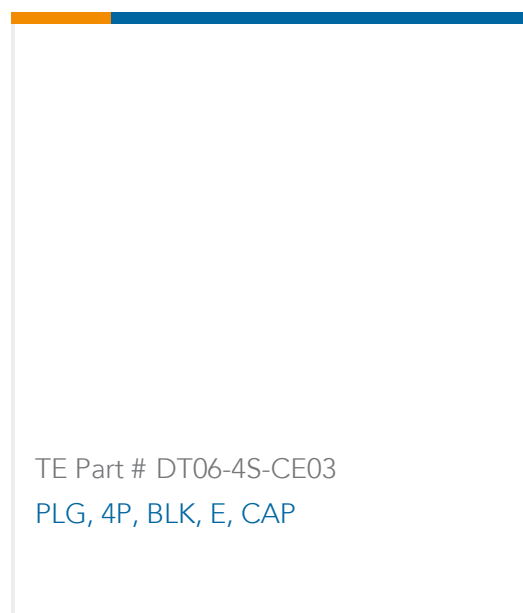

Also in the Series | **DEUTSCH DT**

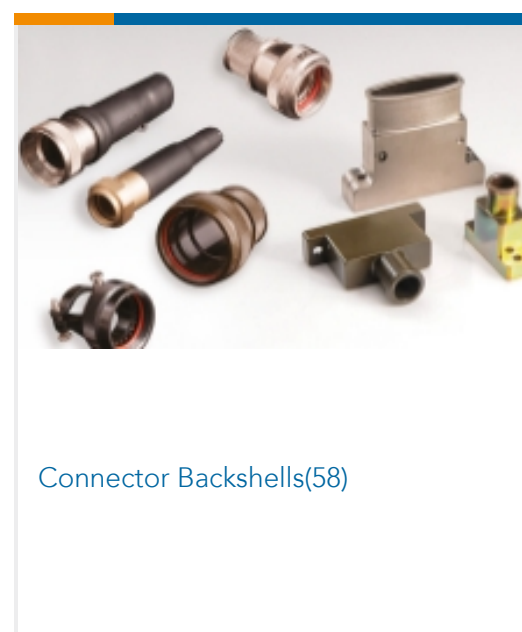
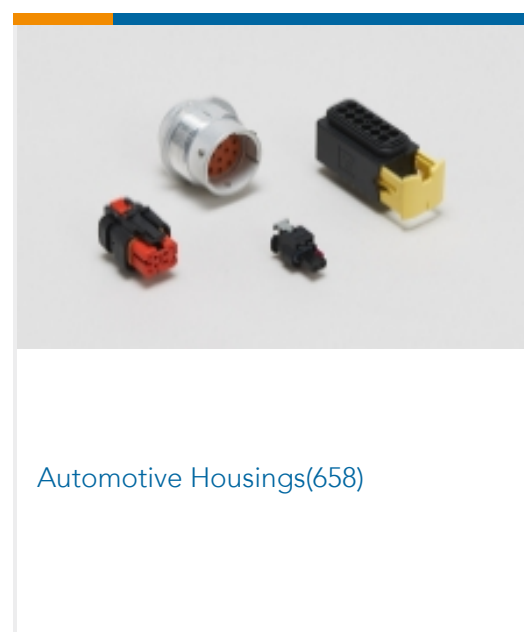
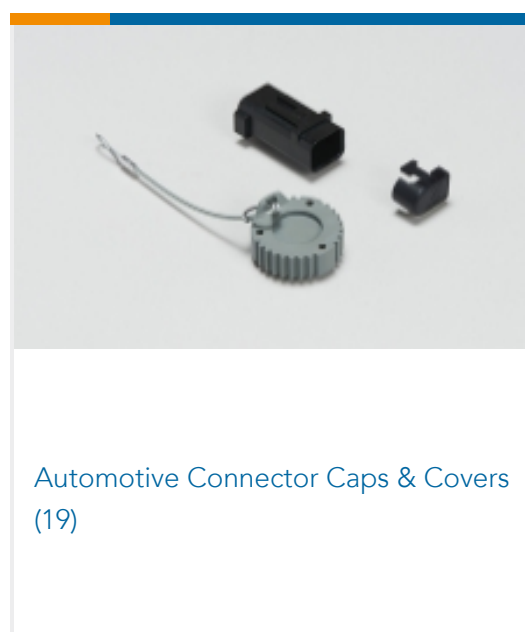

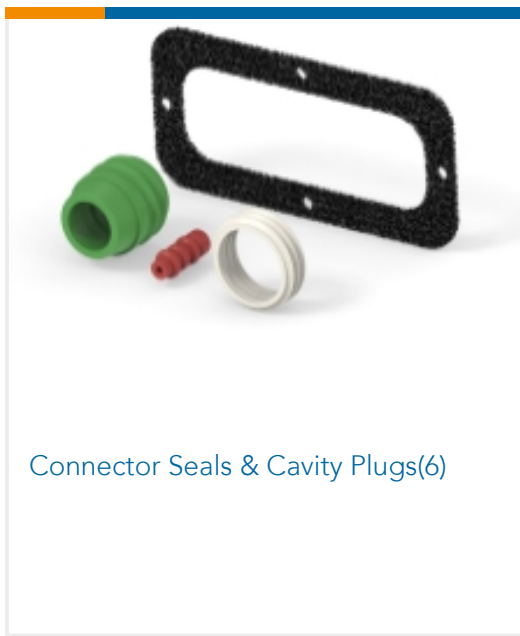

Connector Seals & Cavity Plugs(6)



Connector Strain Relief(28)

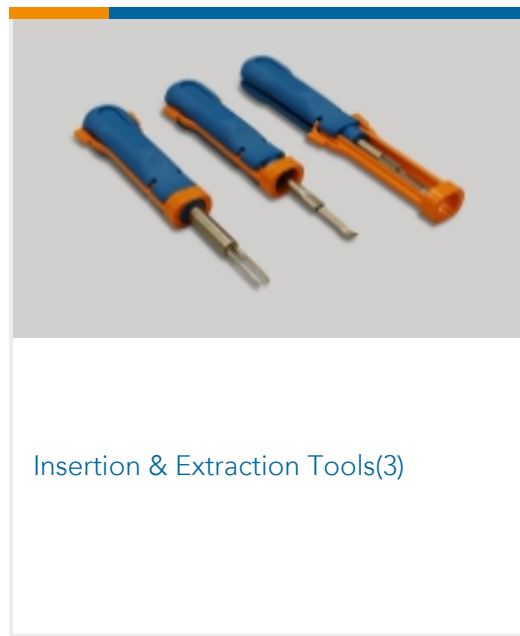

Insertion & Extraction Tools(3)

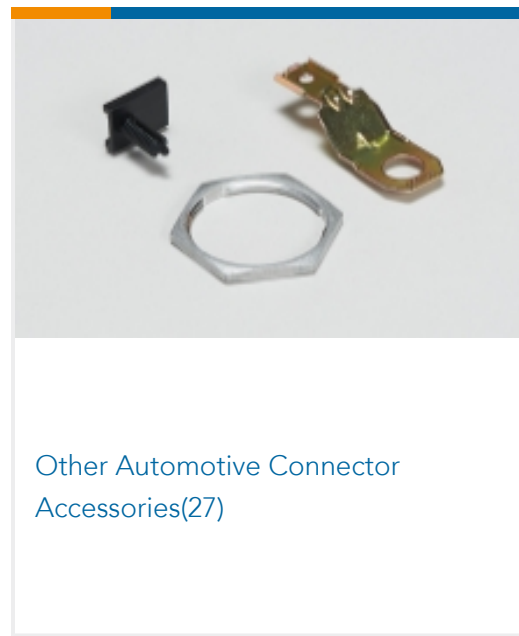

Other Automotive Connector Accessories(27)



PCB Headers & Receptacles(103)

Customers Also Bought



TE Part #W4PD
Wedgelocks: DEUTSCH DT



TE Part #1-6609037-8
3EMC3=F8146



TE Part #6609048-6
6EQ3=F7263 S0



TE Part #3-826646-2
32P AMPMODU II STIFT LEI



TE Part #K1160589
Emergency Switch ES-2002-T312-081E



TE Part #CB3126-000
D-1744-02-LF

Documents

Product Drawings

WEDGE LOCK, 4P, PLG, BLK, STD, DT, B

English

CAD Files

3D PDF

3D

Customer View Model

ENG_CVM_CVM_W4SB_D.2d_dxf.zip



English

Customer View Model

[ENG_CVM_CVM_W4SB_D.3d_igs.zip](#)

English

Customer View Model

[ENG_CVM_CVM_W4SB_D.3d_stp.zip](#)

English

By downloading the CAD file I accept and agree to the [Terms and Conditions](#) of use.

Datasheets & Catalog Pages

[CONNECTOR SELECTOR](#)

English

Agency Approvals

[UL Report](#)

English