NI-9219

Specifications

2022-10-07

Contents

NI-9219 Datasheet.....	3
NI-9219 Specifications.....	12

NI-9219 Datasheet

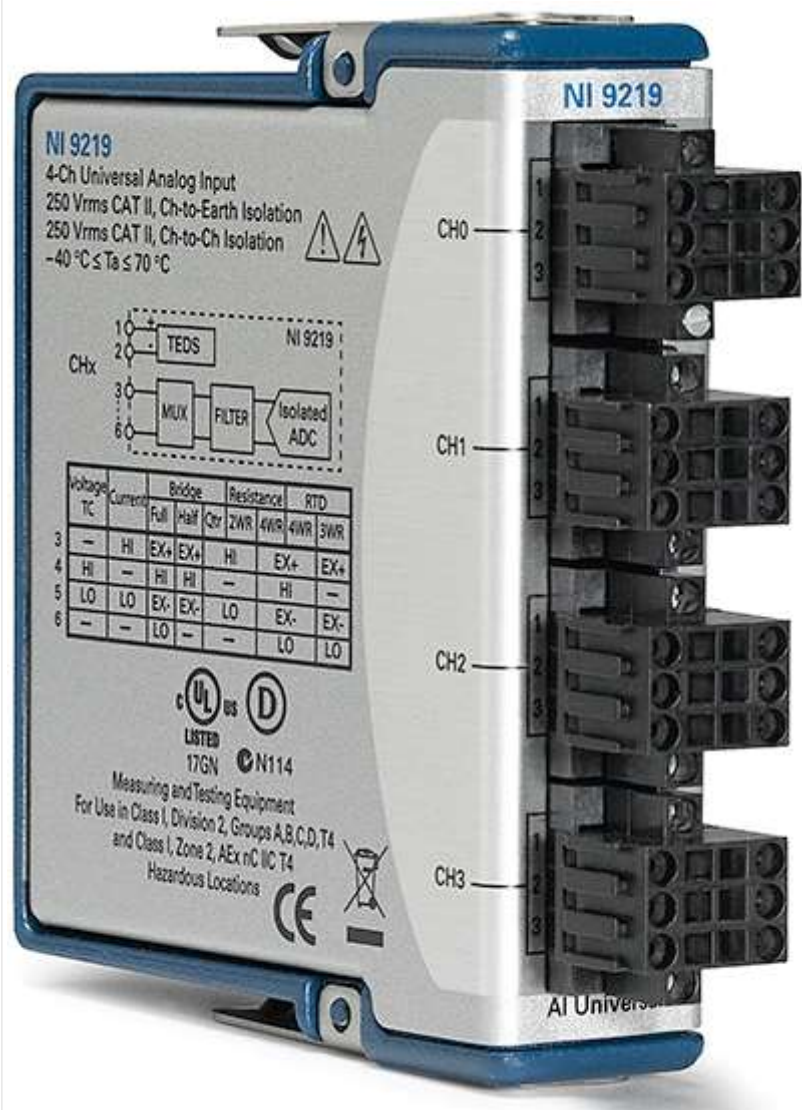

NI 9219
4-Ch Universal Analog Input
250 Vrms CAT II, Ch-to-Earth Isolation
250 Vrms CAT II, Ch-to-Ch Isolation
-40 °C ≤ Ta ≤ 70 °C

CHx

1 2 3
2 3 6

NI 9219

MUX FILTER Isolated ADC

Voltage	TC	Current	Bridge		Resistance		RTD	
			Full	Half	2WR	4WR	4WR	3WR
3	-	HI	EX+	EX+	HI	EX+	EX+	EX+
4	HI	-	HI	HI	-	HI	-	-
5	LO	LO	EX-	EX-	LO	EX-	EX-	EX-
6	-	-	LO	-	-	LO	LO	LO

UL US D
LISTED
17GN N114
Measuring and Testing Equipment
For Use in Class I, Division 2, Groups A,B,C,D,T4
and Class I, Zone 2, AEx nC IIC T4
Hazardous Locations

NI 9219



CH0
CH1
CH2
CH3

AI Universal

- Spring terminal connectivity
- Support for Thermocouple (50 S/s/ch), RTD, Resistance, Full-Bridge, Half-Bridge, Quarter-Bridge, Voltage, and Current Measurements
- Voltage and current excitation
- 250 VAC, CAT II, channel-to-channel isolation

The NI-9219 is a universal C Series module designed for multipurpose testing in any NI CompactDAQ or CompactRIO chassis. With the NI-9219, you can measure several signals from sensors such as strain gages, RTDs, thermocouples, load cells, and other powered sensors. The channels are individually selectable, so you can perform a different measurement type on each of the four channels. Measurement

ranges differ for each type of measurement and include up to ± 60 V for voltage and ± 25 mA for current.

	<p>Kit Contents</p>	<ul style="list-style-type: none"> • NI 9219 • NI 9219 Getting Started Guide • Screw Driver
	<p>Accessories</p>	<ul style="list-style-type: none"> • NI 9972 Backshell Connector Kit

NI C Series Overview



NI provides more than 100 C Series modules for measurement, control, and communication applications. C Series modules can connect to any sensor or bus and allow for high-accuracy measurements that meet the demands of advanced data acquisition and control applications.

- Measurement-specific signal conditioning that connects to an array of sensors and signals
- Isolation options such as bank-to-bank, channel-to-channel, and channel-to-earth ground
- -40 °C to 70 °C temperature range to meet a variety of application and environmental needs
- Hot-swappable

The majority of C Series modules are supported in both CompactRIO and CompactDAQ platforms and you can move modules from one platform to the other with no modification.

CompactRIO



CompactRIO combines an open-embedded architecture with small size, extreme ruggedness, and C Series modules in a platform powered by the NI LabVIEW reconfigurable I/O (RIO) architecture. Each system contains an FPGA for custom timing, triggering, and processing with a wide array of available modular I/O to meet any embedded application requirement.

CompactDAQ

CompactDAQ is a portable, rugged data acquisition platform that integrates connectivity, data acquisition, and signal conditioning into modular I/O for directly interfacing to any sensor or signal. Using CompactDAQ with LabVIEW, you can easily customize how you acquire, analyze, visualize, and manage your measurement data.



Software

LabVIEW Professional Development System for Windows

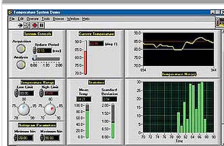

- Use advanced software tools for large project development
- Generate code automatically using DAQ Assistant and Instrument I/O Assistant
- Use advanced measurement analysis and digital signal processing

LabVIEW Professional Development System for Windows

- Take advantage of open connectivity with DLLs, ActiveX, and .NET objects
- Build DLLs, executables, and MSI installers

NI LabVIEW FPGA Module

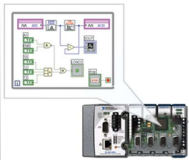

- Design FPGA applications for NI RIO hardware
- Program with the same graphical environment used for desktop and real-time applications
- Execute control algorithms with loop rates up to 300 MHz
- Implement custom timing and triggering logic, digital protocols, and DSP algorithms
- Incorporate existing HDL code and third-party IP including Xilinx IP generator functions
- Purchase as part of the LabVIEW Embedded Control and Monitoring Suite

NI LabVIEW Real-Time Module

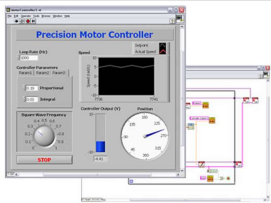

- Design deterministic real-time applications with LabVIEW graphical programming
- Download to dedicated NI or third-party hardware for reliable execution and a wide selection of I/O
- Take advantage of built-in PID control, signal processing, and analysis functions
- Automatically take advantage of multicore CPUs or set processor affinity manually
- Take advantage of real-time OS, development and debugging support, and board support
- Purchase individually or as part of a LabVIEW suite

NI-9219 Circuitry

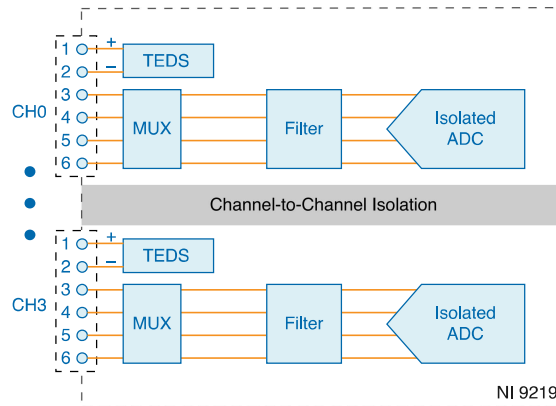

- The NI-9219 is channel-to-channel isolated.
- Four 24-bit analog-to-digital converters (ADCs) simultaneously sample all four analog input channels.
- The NI-9219 enables an excitation circuit for all input modes that require excitation.
- The NI-9219 reconfigures the signal conditioning for each measurement type.

Voltage Circuitry

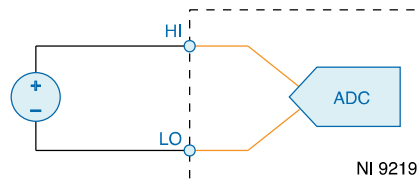

- The ADC measures voltage across the HI and LO terminals.
- The NI-9219 has ± 60 V, ± 15 V, ± 4 V, ± 1 V, and ± 125 mV voltage ranges.

Current Circuitry

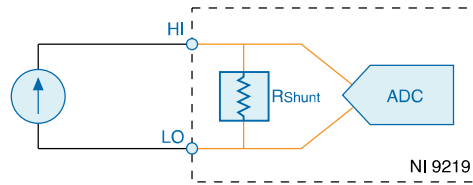

The NI-9219 computes current from the voltage that the ADC measures across an internal shunt resistor.

Thermocouple Circuitry

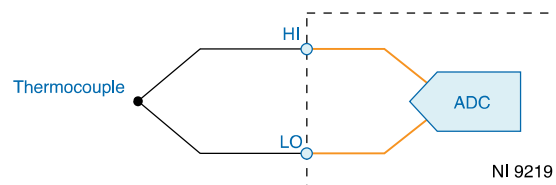

- The NI-9219 uses the ± 125 mV range of the ADC to return a voltage reading.
- Each channel has a built-in thermistor for cold-junction compensation (CJC) calculations.

4-Wire Resistance and 4-Wire RTD Circuitry

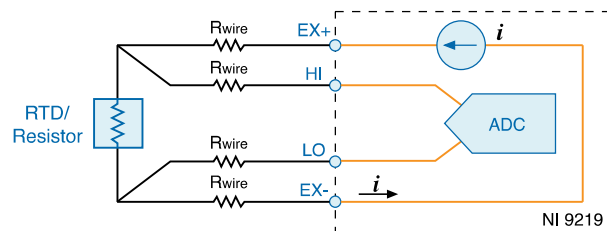

- The NI-9219 sources a current, which varies based on the resistance of the load, between the EX+ and EX- terminals. The NI-9219 computes measured resistance from the resulting voltage reading.
- Lead wire resistance does not affect these measurement types because a negligible amount of current flows across the HI and LO terminals due to the high input impedance of the ADC.

3-Wire RTD Circuitry

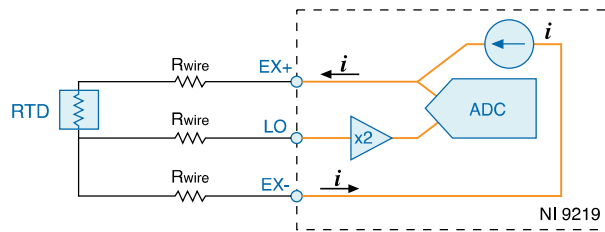

- The NI-9219 sources a current, which varies based on the resistance of the load, between the EX+ and EX- terminals.
- The NI-9219 compensates for lead wire resistance in hardware if all the lead wires have the same resistance.
- The NI-9219 applies a gain of 2x to the voltage across the negative lead wire and the ADC uses this voltage as the negative reference to cancel the resistance error across the positive lead wire.

2-Wire Resistance and Quarter-Bridge Circuitry

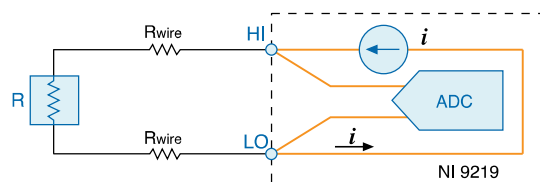

- The NI-9219 sources a current, which varies based on the resistance of the load, between the HI and LO terminals.
- The NI-9219 computes measured resistance from the resulting voltage reading.
- 2-Wire Resistance and Quarter-Bridge measurement types do not compensate for lead wire resistance.

Full-Bridge Circuitry

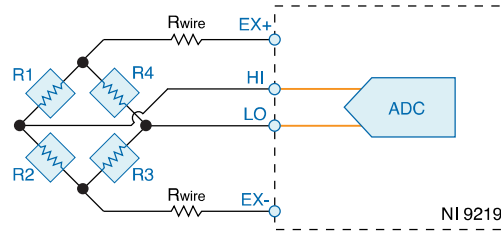

- The ADC reads the HI and LO inputs differentially.
- The internal voltage excitation sets the input range of the ADC and returns voltage readings that are proportional to the excitation level. The internal excitation voltage varies based on the resistance of the sensor.

Half-Bridge Circuitry

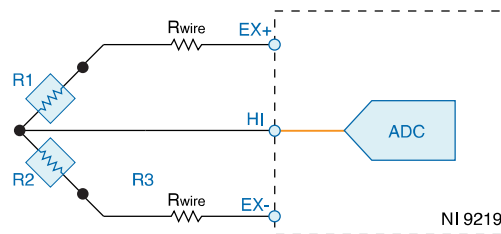

- The HI input is referenced to EX-.
- The internal voltage excitation sets the input range of the ADC and returns voltage readings that are proportional to the excitation level. The internal excitation voltage varies based on the resistance of the sensor.

Digital In Circuitry

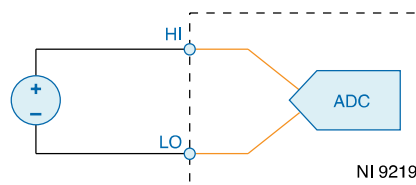

- The NI-9219 has a 60 V unipolar threshold that you can set in software.
- The digital in measurement type is only supported in CompactRIO systems.

Open Contact Circuitry

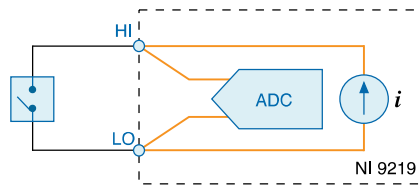

- The NI-9219 sources a current between the HI and LO terminals and determines if the two terminals are open or closed based on the measured current through the terminals.
- When the circuit is open, make sure no more than ± 60 V is sourced across the switch.
- The open contact measurement type is only supported in CompactRIO systems.

Timing Modes

The NI-9219 supports high-resolution, best 50 Hz rejection, best 60 Hz rejection, and high-speed timing modes. High-resolution timing mode optimizes maximum overall noise rejection and provides rejection of 50 Hz and 60 Hz noise. Best 50 Hz rejection optimizes 50 Hz noise rejection. Best 60 Hz rejection optimizes 60 Hz noise rejection. High-speed timing mode optimizes sample rate.

NI-9219 Specifications

The following specifications are typical for the range -40 °C to 70 °C unless otherwise noted.

Caution Do not operate the NI-9219 in a manner not specified in this document. Product misuse can result in a hazard. You can compromise the safety protection built into the product if the product is damaged in any way. If the product is damaged, return it to NI for repair.

Input Characteristics

Number of channels	4 analog input channels
ADC resolution	24 bits
Type of ADC	Delta-sigma (with analog prefiltering)
Sampling mode	Simultaneous
Type of TEDS supported	IEEE 1451.4 TEDS Class 2 (Interface)

Measurement Type	Nominal Range(s)	Actual Range(s)
Voltage	±60 V, ±15 V, ±4 V, ±1 V, ±125 mV	±60 V, ±15 V, ±4 V, ±1 V, ±125 mV
Current	±25 mA	±25 mA
Thermocouple	±125 mV	±125 mV
4-Wire and 2-Wire Resistance	10 kΩ, 1 kΩ	10.5 kΩ, 1.05 kΩ
4-Wire and 3-Wire RTD	Pt 1000, Pt 100	5.05 kΩ, 505 Ω
Quarter-Bridge	350 Ω, 120 Ω	390 Ω, 150 Ω
Half-Bridge	±500 mV/V	±500 mV/V
Full-Bridge	±62.5 mV/V, ±7.8 mV/V	±62.5 mV/V, ±7.8125 mV/V

Measurement Type	Nominal Range(s)	Actual Range(s)
Digital In	—	0 V to 60 V
Open Contact	—	1.05 k Ω

Table 1. Input Ranges

Conversion time, all channels		
No channels configured as a thermocouple		
High speed		10 ms
Best 60 Hz rejection		110 ms
Best 50 Hz rejection		130 ms
High resolution		500 ms
One or more channels configured as a thermocouple		
High speed		20 ms
Best 60 Hz rejection		120 ms
Best 50 Hz rejection		140 ms
High resolution		510 ms
Overvoltage protection		
Terminals 1 and 2		± 30 V
Terminals 3 through 6, across any combination		± 60 V
Input impedance		

Voltage and Digital In (± 60 V, ± 15 V, ± 4 V)	1 M Ω
Current	< 40 Ω
All other measurement types	>1 G Ω

Measurement Type	Range	Gain Error (Percent of Reading)	Offset Error (ppm of Range)
		Typical (25 °C \pm 5 °C), Maximum (-40 °C to 70 °C)	
Voltage	± 60 V	$\pm 0.3, \pm 0.4$	$\pm 20, \pm 50$
	± 15 V	$\pm 0.3, \pm 0.4$	$\pm 60, \pm 180$
	± 4 V	$\pm 0.3, \pm 0.4$	$\pm 240, \pm 720$
	± 1 V	$\pm 0.1, \pm 0.18$	$\pm 15, \pm 45$
Voltage/Thermocouple	± 125 mV	$\pm 0.1, \pm 0.18$	$\pm 120, \pm 360$
Current	± 25 mA	$\pm 0.1, \pm 0.6$	$\pm 30, \pm 100$
4-Wire and 2-Wire ^[1] Resistance	10 k Ω	$\pm 0.1, \pm 0.5$	$\pm 120, \pm 320$
	1 k Ω	$\pm 0.1, \pm 0.5$	$\pm 1200, \pm 3200$
4-Wire and 3-Wire RTD	Pt 1000	$\pm 0.1, \pm 0.5$	$\pm 240, \pm 640$
	Pt 100	$\pm 0.1, \pm 0.5$	$\pm 2400, \pm 6400$
Quarter-Bridge	350 Ω	$\pm 0.1, \pm 0.5$	$\pm 2400, \pm 6400$
	120 Ω	$\pm 0.1, \pm 0.5$	$\pm 2400, \pm 6400$
Half-Bridge	± 500 mV/V	$\pm 0.03, \pm 0.07$	$\pm 300, \pm 450$
Full-Bridge	± 62.5 mV/V	$\pm 0.03, \pm 0.08$	$\pm 300, \pm 1000$
	± 7.8 mV/V	$\pm 0.03, \pm 0.08$	$\pm 2200, \pm 8000$

Table 2. Accuracy

Cold-junction compensation sensor accuracy			± 1 °C typical
Measurement Type	Range	Gain Drift (ppm of Reading/ $^{\circ}$ C)	Offset Drift (ppm of Range/ $^{\circ}$ C)
Voltage	± 60 V	± 20	± 0.2
	± 15 V	± 20	± 0.8
	± 4 V	± 20	± 3.2

Measurement Type	Range	Gain Drift (ppm of Reading/°C)	Offset Drift (ppm of Range/°C)
	±1 V	±10	±0.2
Voltage/Thermocouple	±125 mV	±10	±1.6
Current	±25 mA	±15	±0.4
4-Wire and 2-Wire Resistance	10 kΩ	±15	±3
	1 kΩ	±15	±30
4-Wire and 3-Wire RTD	Pt 1000	±15	±6
	Pt 100	±15	±60
Quarter-Bridge	350 Ω	±15	±120
	120 Ω	±15	±240
Half-Bridge	±500 mV/V	±3	±20
Full-Bridge	±62.5 mV/V	±3	±20
	±7.8 mV/V	±3	±20

Table 3. Stability

Measurement Type	Range	Timing Mode			
		High Speed	Best 60 Hz Rejection	Best 50 Hz Rejection	High Resolution
Voltage	±60 V	7.6	1.3	1.3	0.5
	±15 V	10.8	1.9	1.9	0.7
	±4 V	10.8	2.7	2.7	1.3
	±1 V	7.6	1.3	1.3	0.5
Voltage/Thermocouple	±125 mV	10.8	1.9	1.9	1.0
Current	±25 mA	10.8	1.9	1.9	1.0
4-Wire and 2-Wire Resistance	10 kΩ	4.1	1.3	0.8	0.3
	1 kΩ	7.1	1.8	1.2	0.7
4-Wire and 3-Wire RTD	Pt 1000	7.6	1.7	1.1	0.4
	Pt 100	10.8	1.9	1.9	0.9
Quarter-Bridge	350 Ω	5.4	1.0	1.0	0.7
	120 Ω	5.4	1.0	1.0	0.7
Half-Bridge	±500 mV/V	3.8	0.5	0.5	0.2
Full-Bridge	±62.5 mV/V	5.4	1.0	1.0	0.8

Measurement Type	Range	Timing Mode			
		High Speed	Best 60 Hz Rejection	Best 50 Hz Rejection	High Resolution
	±7.8 mV/V	30	4.7	4.7	2.3

Table 4. Input Noise in ppm of Range_{rms}

Input bias current	<1 nA
INL	±15 ppm
CMRR ($f_{in} = 60$ Hz)	>100 dB
NMRR	
Best 60 Hz rejection	90 dB at 60 Hz
Best 50 Hz rejection	80 dB at 50 Hz
High resolution	65 dB at 50 Hz and 60 Hz

Measurement Type	Load Resistance (Ω)	Characteristic Excitation Level ^[2]
Half-Bridge	700	2.5 V
	240	2.0 V
Full-Bridge	350	2.7 V
	120	2.2 V
Resistance, RTD, and Quarter-Bridge	120	50 mV
	350	150 mV
	1,000	430 mV
	10,000	2200 mV

Table 5. Half-Bridge, Full-Bridge, Quarter-Bridge, Resistance, and RTD Excitation Level

MTBF	384,716 hours at 25 °C; Bellcore Issue 2, Method 1, Case 3, Limited Part Stress Method
------	--

Power Requirements

Power consumption from chassis	
Active mode	750 mW maximum
Sleep mode	25 μ W maximum
Thermal dissipation (at 70 °C)	
Active mode	625 mW maximum
Sleep mode	25 μ W maximum

Physical Characteristics

Spring-terminal wiring	
Gauge	copper conductor wire
Wire strip length	of insulation stripped from the end
Temperature rating	
Wires per spring terminal	
Connector securement	
Securement type	Screw flanges provided
Torque for screw flanges	

NI-9219 Safety Voltages (Black Connector)

Connect only voltages that are within the following limits.

Channel-to-channel

Continuous 250 V AC, Measurement Category II

Withstand 1,390 V AC, verified by a 5 s dielectric withstand test

Channel-to-earth ground

Continuous 250 V AC, Measurement Category II

Withstand 2,300 V AC, verified by a 5 s dielectric withstand test

Zone 2 hazardous locations applications in Europe

Channel-to-channel and channel-to-earth ground 60 V DC, Measurement Category I

Hazardous Locations

U.S. (UL)	;
Canada (C-UL)	;
Europe (ATEX) and International (IECEX)	DEMKO ATEX IECEX

Safety Compliance and Hazardous Locations Standards

This product is designed to meet the requirements of the following electrical equipment safety standards for measurement, control, and laboratory use:

- IEC 61010-1, EN 61010-1
- UL 61010-1, CSA C22.2 No. 61010-1
- EN 60079-0, EN 60079-7
- IEC 60079-0, IEC 60079-7
- UL 60079-0, UL 60079-7
- CSA C22.2 No. 60079-0, CSA C22.2 No. 60079-7

Note For safety certifications, refer to the product label or the [Product Certifications and Declarations](#) section.

Electromagnetic Compatibility

- EN 61326 (IEC 61326): Class A emissions; Industrial immunity

Note For the standards applied to assess the EMC of this product, refer to the [Online Product Certification](#) section.

CE Compliance

- 2014/34/EU; Potentially Explosive Atmospheres (ATEX)

Product Certifications and Declarations

Refer to the product Declaration of Conformity (DoC) for additional regulatory compliance information. To obtain product certifications and the DoC for NI

products, visit ni.com/product-certifications, search by model number, and click the appropriate link.

Shock and Vibration

To meet these specifications, you must panel mount the system.

Operating vibration	
Random	5 g RMS, 10 Hz to 500 Hz
Sinusoidal	5 g, 10 Hz to 500 Hz
Operating shock	30 g, 11 ms half sine; 50 g, 3 ms half sine; 18 shocks at 6 orientations

Environmental

Refer to the manual for the chassis you are using for more information about meeting these specifications.

Operating temperature (IEC 60068-2-1, IEC 60068-2-2)	-40 °C to 70 °C
Storage temperature (IEC 60068-2-1, IEC 60068-2-2)	-40 °C to 85 °C
Ingress protection	IP40
Operating humidity (IEC 60068-2-30)	10% RH to 90% RH, noncondensing
Storage humidity (IEC 60068-2-30)	5% RH to 95% RH, noncondensing
Pollution Degree	2

Maximum altitude	2,000 m
------------------	---------

Indoor use only.

Environmental Management

NI is committed to designing and manufacturing products in an environmentally responsible manner. NI recognizes that eliminating certain hazardous substances from our products is beneficial to the environment and to NI customers.

For additional environmental information, refer to the **Engineering a Healthy Planet** web page at ni.com/environment. This page contains the environmental regulations and directives with which NI complies, as well as other environmental information not included in this document.

EU and UK Customers

-  **Waste Electrical and Electronic Equipment (WEEE)**—At the end of the product life cycle, all NI products must be disposed of according to local laws and regulations. For more information about how to recycle NI products in your region, visit ni.com/environment/weee.

电子信息产品污染控制管理办法（中国 RoHS）

-  **中国 RoHS**— NI 符合中国电子信息产品中限制使用某些有害物质指令(RoHS)。关于 NI 中国 RoHS 合规性信息，请登录 ni.com/environment/rohs_china。(For information about China RoHS compliance, go to ni.com/environment/rohs_china.)

Calibration

You can obtain the calibration certificate and information about calibration services for the NI-9219 at ni.com/calibration.

Calibration interval	1 year
----------------------	--------

¹ 2-wire resistance accuracy assumes 0 Ω of lead wire resistance. 2-wire resistance accuracy depends on the lead wire resistance.

² Excitation level is a characteristic and is not software-selectable.