

**TW Series – 22mm NEMA Style Pushbuttons**



**Key features:**

- TW NEMA Style Switches with snap-on contacts
- Corrosion resistant octagonal chrome plated locking bezel
- Snap-on 10A contact blocks
- LED illumination
- Slow make, double break, contacts
- Modular construction for maximum flexibility
- Type 4X and IP65 watertight/oiltight panel
- Available assembled or as sub-components
- Finger-Safe - Spring-Up
- Large M3.5 screw terminals with captive sems plate

IDEC has your 22mm switching needs covered.

Button styles include flush, extended, mushroom, or square and all bodies are crafted from fracture-resistant nylon.

All illuminated units feature two lens styles, one that maximizes light dispersion, the other accommodates direct lens engraving.

Contact mechanism allow for a wide current rating, 5mA to 10A, which reduces the need for various contact materials.

When looking for a 22mm switch that is durable, easy to use, and versatile, then IDEC's TW series is your solution.



UL Listed  
File No. E68961



TUV Rheinland



CSA Approved  
File No. LR21451



File No. DK95-01696



Certificate No.  
2030010305027380



Switches & Pilot Devices

Signaling Lights





Relays & Sockets

Timers

Contactors

Terminal Blocks

Circuit Breakers

Conforming to Standards		EN60947-1, EN60947-5-1, VDE0660-200, UL508, CSA C22-2 No.14					
Approvals		 File No. E68961  File No. LR21451  Certificate No. 2030010305027380   Registration No: J9551802 (E-Stops) Registration No: J9551803 (All other switches) Registration No: J9551804 (Pilot Lights)					
Operating Temperature		Operation: -25 to +50°C (without freezing), Storage: -40 to +80°C (without freezing)					
Vibration Resistance		5 to 55Hz, 100m/sec <sup>2</sup> (10g) conforming to IEC6068-2-6					
Shock Resistance		1000m/sec <sup>2</sup> (100g) conforming to IEC6068-2-7					
Electric Shock Protection		Class 2 conforming to IEC60664-7					
Degree of Protection (conforming to IEC60529) (conforming to NEMA ICS6-110)		IP65 from front of the panel; (IP54 for key switches) IP20 (Type HW-U contact block) Type 1, 2, 3, 3R, 3S, 4, 4X, 5, 12, 13 (Type 1, 2, 3R, 5, 12, 13 for key switches)					
Mechanical Life		Momentary pushbuttons: 5,000,000 (1800 operations per hour) All other switches: 500,000					
Pollution Degree (conforming to IEC60947-1)		3					
Rated Operational Characteristics		AC-15: A600 or Ue = 250V, Ie = 3A (NO, NC, NO-EM, NC-LB) DC-13: P600 or Ue = 125V, Ie = 1.1A (NO, NC) DC-13: Q600 or Ue = 125V, Ie = 0.9A (NO-EM, NC-LB)					
Rated Insulation Voltage		600V					
Rated Switching Over-Voltage		Less than 4kV, conforming to IEC60947-1					
Rated Impulse Withstanding Voltage		4kV for contact circuit, 2.5kV for lamp circuit					
Rated Thermal Current		10 Amp					
Minimum Switching Capacity		5 mA at 3V AC/DC					
Contact Operation		Slow break NC or slow make NO, self-cleaning					
Recommended Terminal Torque		Unit		Wire	Number of Wires	Recommended Tightening Torque (Nm)	Terminal Screw
		HW-U Contact Block		Crimping Terminal Solid Wire ø0.5 to 1.6 mm (AWG14 to 22) ø1.7 to 2.0 mm (AWG12) Stranded Wire 0.3 to 2.0 mm <sup>2</sup> (AWG14 to 22) 2.1 to 3.5 mm <sup>2</sup> (AWG12)	2 2 1 2 1	1.0 to 1.3 1.0 to 1.3 1.2 to 1.3 1.0 to 1.3 1.2 to 1.3	M3.5
Applicable Wire Size		Illuminated Unit (*1)		Crimping Terminal Solid Wire ø0.5 to 1.6 mm (AWG14 to 22) Stranded Wire 0.3 to 2.0 mm (AWG14 to 22)	2	1.0 to 1.3	M3.5
		Pilot Light		Crimping Terminal Solid Wire ø0.5 to 1.6 mm (AWG14 to 22) Stranded Wire ø0.3 to 2.0 mm (AWG14 to 22)	2	0.6 to 1.0 (M3.0) 1.0 to 1.3 (M3.5)	
External Short-Circuit Protection		10A 250V fuse conforming to IEC60269-1					
Applicable Wire Size		Minimum 1 x 22 AWG, max. 2 x 14 AWG or 1 x 12 AWG					
Contact Resistance		Initial contact resistance of 50mΩ or less					
Contact Gap		4mm (NO and NC), 2mm (NO-EM and NC-LB)					
Electrical Reliability		MTBF < 1 fault for 10 million operation cycles (3V DC, 5mA)					
Lamp Ratings		LEDs: 6V: 17mA max, 12/24V: 11mA max, 120/240V: 10mA max					
Horsepower Rating		1/4 HP @ 120V (single-phase, non-reversing motor); 1 HP @ 240V (3 phase, non-reversing motor)					
Contact Material		Silver					

Contact Ratings	Pushbuttons Illuminated Pushbuttons Selector Switches Illuminated Selector Switches Pushbutton Selectors	Contact Block	Type HW-U
		Rated Insulation Voltage	600V
		Rated Continuous Current	10A
		Contact Ratings by Utilization Category IEC 60947-5-1	AC-15 (A600) DC-13 (P600)

		Contact Ratings by Utilization Category							
			24V	48V	50V	110V	220V	440V	
Characteristics	Operational Voltage								
	Operational Current	AC50/60Hz	AC-12 Control of resistive loads and solid state loads	10A	—	10A	10A	6A	2A
		DC	AC-15 Control of electromagnetic loads (> 72VA)	10A	—	7A	5A	3A	1A
	DC-12 Control of resistive loads and solid state loads		10A	5A	—	2.2A	1.1A	—	
	DC-13 Control of electromagnets	5A	2A	—	1.1A	0.6A	—		











Non-Illuminated Pushbuttons (Assembled)



To be used for interpreting part numbers only, not for part number development.

Non-Illuminated Pushbuttons (Assembled) continued

Non-Illuminated Pushbuttons

	Style	Contacts	Momentary Action	Maintained Action
Flush		1NO 1NC 1NO-1NC 2NO 2NC	ABW110-① ABW101-① ABW111-① ABW120-① ABW102-①	AOW110-① AOW101-① AOW111-① AOW120-① AOW102-①
Extended		1NO 1NC 1NO-1NC 2NO 2NC	ABW210-① ABW201-① ABW211-① ABW220-① ABW202-①	AOW210-① AOW201-① AOW211-① AOW220-① AOW202-①
Recessed		1NO 1NC 1NO-1NC 2NO 2NC	ABFW110-① ABFW101-① ABFW111-① ABFW120-① ABFW102-①	AOFW110-① AOFW101-① AOFW111-① AOFW120-① AOFW102-①
Extended with Full Shroud		1NO 1NC 1NO-1NC 2NO 2NC	ABFW210-① ABFW201-① ABFW211-① ABFW220-① ABFW202-①	AOFW210-① AOFW201-① AOFW211-① AOFW220-① AOFW202-①
Ø 29mm Mushroom Head		1NO 1NC 1NO-1NC 2NO 2NC	ABW310-① ABW301-① ABW311-① ABW320-① ABW302-①	AOW310-① AOW301-① AOW311-① AOW320-① AOW302-①
Ø 40mm Mushroom Head		1NO 1NC 1NO-1NC 2NO 2NC	ABW410-① ABW401-① ABW411-① ABW420-① ABW402-①	AOW410-① AOW401-① AOW411-① AOW420-① AOW402-①
Ø 40mm Mushroom Head with Full Shroud		1NO 1NC 1NO-1NC 2NO 2NC	ABGW410-① ABGW401-① ABGW411-① ABGW420-① ABGW402-①	AOGW410-① AOGW401-① AOGW411-① AOGW420-① AOGW402-①
Square Flush		1NO 1NC 1NO-1NC 2NO 2NC	ABQW110-① ABQW101-① ABQW111-① ABQW120-① ABQW102-①	AQW110-① AQW101-① AQW111-① AQW120-① AQW102-①
Square Extended		1NO 1NC 1NO-1NC 2NO 2NC	ABQW210-① ABQW201-① ABQW211-① ABQW220-① ABQW202-①	AQW210-① AQW201-① AQW211-① AQW220-① AQW202-①
Keylock Push On/Off		1NO 1NC 1NO-1NC 2NO 2NC	AKW210 AKW201 AKW211 AKW220 AKW202	—

① Button Color Codes

Color	Code
Black	B
Green	G
Red	R
Blue	S
Yellow	Y
White	W

- 1. In place of ①, specify the Button Color Code from table.
- 2. For sub-assembled part numbers, see next page.
- 3. For accessories, see page 728.
- 4. For dimensions, see page 730.
- 5. Keyed switches are supplied with two keys. All units are keyed alike.

Non-Illuminated Pushbuttons (Sub-Assembled)



Operators

Style	Part Number	
	Momentary	Maintained
Round Flush/Extended 	ABW-100	AOW-100
Round with Full Shroud/Recessed 	ABFW-200	AOFW-200
Ø 40mm, Ø 29mm Mushroom Head 	ABW-300	AOW-300
Ø 40mm Mushroom Head with Full Shroud 	ABGW-400	AOGW-400
Square Flush/Extended 	ABQW-100	AQQW-100
Keylock Push On/Off 	—	AKW-200



Buttons

Style	Part Number
Round Flush 	ABW1B-①
Round Extended 	ABW2B-①
Ø 29mm Mushroom 	ABW3B-①
Ø 40mm Mushroom 	ABW4B-①
Square Flush 	ABQW1B-①
Square Extended 	ABQW2B-①

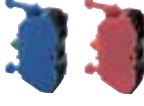

In place of ① specify the button color code from table

Contact Blocks

Style	Contacts	1NO	1NC
	Finger-Safe Spring-Up Terminal	HW-U10-F HW-U10R-F (early make)	HW-U01-F HW-U01R-F (late break)
	Dummy Block	HW-DB	



- Dummy blocks (no contacts) are used with an odd number of contact blocks.
- Use of early and late break contacts creates a make before break function

① Button Color Codes

Color	Code
Black	B
Green	G
Red	R
Blue	S
Yellow	Y
White	W

Stop Switches (Assembled)



 To be used for interpreting part numbers only, not for part number development.

**Assembled Stop Switches**

A V (L) W 4 (B) (99) 11 (D) - R - (24V)

<p><b>Function</b></p> <p>V: Pushlock Turn Reset Y: Push-Pull X: Pushlock Key Reset</p> <p><b>Illumination</b></p> <p>Blank: None L: Illuminated</p> <p><b>Series Designation</b></p> <p>W: TW Series</p> <p><b>Button/Lens Size</b></p> <p>3: 29mm Mushroom 4: 40mm Mushroom</p> <p><b>Lens Type</b> (illuminated units only)</p> <p>Blank: Standard (ribbed) B: Engravable (smooth with insert)</p> <p><b>Illuminated Circuit</b> (illuminated unit only)</p> <p>99: Full Voltage (LED determines voltage) 126: 120V AC Step Down Transformer 246: 240V AC Step Down Transformer 486: 480V AC Step Down Transformer</p>	<p><b>Lamp Voltage</b> (full voltage illuminated units only)</p> <p>6V: 6V AC/DC 12V: 12V AC/DC 24V: 24V AC/DC 120V: 120V AC 240V: 240V AC</p> <p><b>Button/Lens Color</b></p> <p>A: Amber R: Red W: White G: Green S: Blue Y: Yellow B: Black</p> <p><b>Lamp Type</b> (illuminated units only)</p> <p>D: LED</p> <p><b>Contact Arrangement</b></p> <p>10: 1NO 01: 1NC 20: 2NO 02: 2NC 11: 1NO/1NC 22: 2NO/2NC</p>
---	--

Stop Switches (Assembled), continued

Non-Illuminated Stop Switches

Style	Contacts	Part Number
 Ø 40mm Pushlock Turn Reset*	1NO	AVW410-R*
	1NC	AVW401-R*
	1NO-1NC	AVW411-R*
	2NO	AVW420-R*
	2NC	AVW402-R*
 Ø 29mm Pushlock Turn Reset*	1NO	AVW310-R*
	1NC	AVW301-R*
	1NO-1NC	AVW311-R*
	2NO	AVW320-R*
	2NC	AVW302-R*
 Ø 40mm Push-Pull	1NO	AYW410-①
	1NC	AYW401-①
	1NO-1NC	AYW411-①
	2NO	AYW420-①
	2NC	AYW402-①
 Ø 40mm Pushlock Key Reset*	1NO	AXW410- R*
	1NC	AXW401- R*
	1NO-1NC	AXW411- R*
	2NO	AXW420- R*
	2NC	AXW402- R*

① Button Color Codes

Color	Code
Black	B
Green	G
Red	R
Blue	S
White	W
Yellow	Y

② LED/Lens Color Codes

Color	Code
Amber	A
Green	G
Red	R
Blue	S
White	W

③ Full Voltage Codes

Voltage	Code
6V AC/DC	6V
12V AC/DC	12V
24V AC/DC	24V
120V AC	120V
240V AC	240V



④ Transformer Voltage Codes

Voltage	Code
120VAC	126
240VAC	246
480VAC	486

 Transformers step down to 6V.

- \*Available in Red only.
- In place of ①, specify the Button Color Code from table.
- For sub-assembled part numbers, see next page.
- For accessories, see page 728.
- For dimensions, see page 730.

Illuminated Stop Switches

Style	Type	Contacts	Part Number
 Ø 40mm Pushlock Turn Reset Type	Transformer	1NO-1NC	AVLW4 ④ 11D-R*
		2NO	AVLW4 ④ 20D-R*
		2NC	AVLW4 ④ 02D-R*
	Full Voltage	1NO-1NC	AVLW49911D-R*-③
 Ø 29mm Pushlock Turn Reset	Transformer	1NO-1NC	AVLW3④11D-R*
		2NO	AVLW3④20D-R*
		2NC	AVLW3④02D-R*
	Full Voltage	1NO-1NC	AVLW39911D-R*-③
		2NO	AVLW39920D-R*-③
		2NC	AVLW39902D-R*-③
 Ø 40mm Push-Pull	Transformer	1NO-1NC	AYLW4 ④ 11D-②
		2NO	AYLW4 ④ 20D-②
		2NC	AYLW4 ④ 02D-②
	Full Voltage	1NO-1NC	AYLW49911D-②-③
		2NO	AYLW49920D-②-③
		2NC	AYLW49902D-②-③

- \*Available in red only.
- In place of ②, specify the Lens Color Code (see table above).
- In place of ③, specify the Full Voltage Code (lamp voltage) (see table above).
- In place of ④, specify the Transformer Voltage Code (see table above).
- For sub-assembly part numbers, see next page.
- For accessories, see page 728.
- For dimensions, see page 730.

Stop Switches (Sub-Assembled)

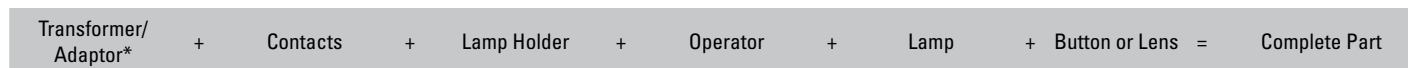

\*Not applicable for full voltage units

Operators

Style	Part Number	
	Non-Illuminated	Illuminated
Ø 29/Ø 40mm Pushlock Turn Reset 	AVW-300	AVLW3-0600
Ø 40mm Push-Pull 	AYW-400	AYLW4-0600
Ø 40mm Pushlock Key Reset 	AXW-300	—

Buttons

Style	Part Number
Ø 40mm Pushlock Turn Reset 	AVW4B-R*
Ø 29mm Pushlock Turn Reset 	AVW3B-R*
Ø 40mm Push-Pull 	AYW4B-⊙
Ø 40mm Pushlock Key Reset 	AXW4B-R*

- 1. \*Available in Red only
- 2. In place of ⊙, specify the button color code from table.

Lamps

Style	Voltage	Part Number
LED 	6V AC/DC	LSTD-6⊙
	12V AC/DC	LSTD-1⊙
	24V AC/DC	LSTD-2⊙
	120V AC	LSTD-H2⊙
	240V AC	LSTD-M4⊙

- 1. In place of ⊙, specify the LED color code.
- 2. The LED contains a current-limiting resistor and a protection diode.

① Button Color Codes

Color	Code
Black	B
Green	G
Red	R
Blue	S
White	W
Yellow	Y

② LED/Lens Color Codes

Color	Code
Amber	A
Green	G
Red	R
Blue	S
White	W





**Illuminated Stop Switches (Sub-Assembled) continued**

**Lenses**

Style	Part Number	
	Standard	Engravable
Ø 29mm Head Pushlock Turn Reset 	AVLW3LU-R*	AVLW3BLU-R*
Ø 40mm Head Pushlock Turn Reset 	AVLW4LU-R*	AVLW4BLU-R*
Ø 40mm Head Push Pull 	AYLW4LU-Ⓢ	AYLW4BLU-Ⓢ

- 1. In place of Ⓢ, specify the lens color code from table on previous page.
- 2. \*Available only in red
- 3. Standard lenses have ribbed pattern, Engravable lenses are smooth and include an engravable insert.

**Lamp Circuit Components**



Style	Application	Part Number
Long Lamp Holder 	<b>Used with</b> Full-size Transformer and two contact blocks	TW-LH2
Lead Holder 	<b>Used with</b> TW-LH2 holder when using four contact blocks and transformer	HW-LH3

**Transformers/Full Voltage Modules**

Style	Description	Part Number
Full Size Transformer 	120V AC	TW-F126B
	240V AC	TW-F246B
	480V AC	TW-F486B
Dummy Block with Full Voltage Adaptor 	For use with odd number of contacts. Finger-Safe	HW-DA1FBN
Full Voltage Adaptor 	For use with even number of contacts. Finger-Safe	TW-DA1FB

 All Transformers step down to 6V (use 6V LED).

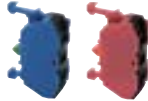
**Contact Blocks**

Style	Contacts	1NO	1NC
	Finger-Safe Spring-Up Terminal	HW-U10-F	HW-U01-F
		HW-U10R-F (early make)	HW-U01R-F (late break)
	Dummy Block	HW-DB	

- 1. Dummy blocks (no contacts) are used with an odd number of contact blocks.
- 2. Use of early and late break contacts creates a make before break function

Pilot Lights (Assembled)



Assembled Pilot Lights

A P (Q) W 1 (B) (99) (D) - R - (24V)

**Function**

P: Pilot Light

**Bezel Shape**

Blank: Octagonal (round lenses)  
Q: Square

**Series Designation**

W: TW Series

**Lens Shape**

1: Flat  
2: Dome

**Lens Type**

Blank: Standard (ribbed)  
B: Engravable (smooth with insert included)

**Illumination Circuit**

- 99: Full Voltage (lamp determines voltage)
- 126: 120V AC Step Down Transformer
- 246: 240V AC Step Down Transformer
- 486: 480V AC Step Down Transformer



1. Use only when interpreting part numbers. Do not use for developing part numbers.
2. All transformers step down to 6V.

**Lamp Voltage**

(Full Voltage Units Only)

- 6V: 6V AC/DC
- 12V: 12V AC/DC
- 24V: 24V AC/DC
- 120V: 120V AC
- 240V: 240V AC

**Lens Color Code**

- A: Amber
- G: Green
- R: Red
- S: Blue
- W: White
- Y: Yellow

**Lamp**

D: LED

Pilot Lights (Assembled) continued

Assembled Pilot Lights

Style	Type	Voltage	Part Number
Round Flat	Transformer	120VAC 240VAC 480VAC	APW1126D-② APW1246D-② APW1486D-②
	Full Voltage	—	APW199D-②-③
Dome	Transformer	120VAC 240VAC 480VAC	APW2126D-② APW2246D-② APW2486D-②
	Full Voltage	—	APW299D-②-③
Square Flat	Transformer	120VAC 240VAC 480VAC	APQW1B126D-② APQW1B246D-② APQW1B486D-②
	Full Voltage	—	APQW1B99D-②-③

② Lens Color Codes

Color	Code
Amber	A
Green	G
Red	R
Blue	S
White	W
Yellow	Y

③ Full Voltage Codes

Voltage	Code
6V AC/DC	6V
12V AC/DC	12V
24V AC/DC	24V
120V AC	120V
240V AC	240V

- 1. In place of ②, specify the Lens Color Code from table below.
- 2. In place of ③, specify the Full Voltage Code from table below.
- 3. For accessories, see page 728.
- 4. For dimensions, see page 730.
- 5. For sub-assembly part numbers, see next page.
- 6. Yellow pilot light comes with white LED.

Pilot Lights (Sub-Assembled)



\* Transformer not required for full voltage units.

Operators

Style	Part Number
Round Dome/Flat	APW-199
	
Square	UPQW-199
	



Same operator is used for full voltage as for transformer completed units.

Lamps

Style	Voltage	Part Number
LED	6V AC/DC	LSTD-6Ⓢ
	12V AC/DC	LSTD-1Ⓢ
	24V AC/DC	LSTD-2Ⓢ
	120V AC	LSTD-H2Ⓢ
	240V AC	LSTD-M4Ⓢ



1. In place of Ⓢ, specify the LED color code.
2. The LED contains a current-limiting resistor and a protection diode.
3. Yellow LED not available. Use white LED.

Ⓢ LED/Lens Color Codes

Color	Code
Amber	A
Green	G
Red	R
Blue	S
White	W
Yellow	Y



If clear lens is desired, use white marking lens and remove engraving insert

Transformers

Style	Description	Part Number
	120V AC	TW-F126B
	Finger-Safe 240V AC	TW-F246B
	480V AC	TW-F486B



All Transformers step down to 6V (use 6V LED).

Lenses

Style	Part Number	
	Standard	Engravable
Dome	APW2LU-Ⓢ	—
		
Round Flat	APW1LU-Ⓢ	APW1BLU-Ⓢ
		
Square Flat	—	APQW1BLU-Ⓢ
		



1. In place of Ⓢ, specify the Lens Color Code from table.
2. Standard lenses have a ribbed lens to enhance light dispersion. Marking lenses are smooth and include an engraving insert.

**Illuminated Pushbuttons (Assembled)**



**Assembled Illuminated Pushbuttons**

**A L (F) W 2 (B) 99 11 (D) - R - (24V)**

**Function**

L: Momentary Action  
OL: Maintained Action

**Bezel Shape**

Blank: Octagonal (round lenses)  
F: Full Shroud (round lenses)  
O: Square

**Series Designation**

W: TW series

**Lens Shape/Size**

2: Standard Extended (round or square)  
3: 29mm Mushroom  
4: 40mm Mushroom

**Lens Type**

Blank: Standard (ribbed)  
B: Engravable (smooth with insert)

**Illumination Circuit**

99: Full Voltage (lamp determines voltage)  
126: 120V AC Step Down Transformer  
246: 240V AC Step Down Transformer  
486: 480V AC Step Down Transformer

**Lamp Voltage**

(Full Voltage Units Only)

6V: 6V AC/DC  
12V: 12V AC/DC  
24V: 24V AC/DC  
120V: 120V AC  
240V: 240V AC

**Lens Code**

A: Amber  
G: Green  
R: Red  
S: Blue  
W: White  
Y: Yellow

**Lamp Type**

D: LED Lamp

**Contact Arrangement**

10: 1NO	01: 1NC
20: 2NO	02: 2NC
11: 1NO-1NC	22: 2NO-2NC



1. Use only when interpreting part numbers. Do not use for developing part numbers.
2. Transformers step down to 6V.

Illuminated Pushbuttons (Assembled)

Illuminated Pushbuttons

Style	Contacts	Part Number		
		Momentary	Maintained	
Extended Lens 	Transformer	1NO-1NC 2NO 2NC	ALW2 ④ 11D-② ALW2 ④ 20D-② ALW2 ④ 02D-②	AOLW2 ④ 11D-② AOLW2 ④ 20D-② AOLW2 ④ 02D-②
	Full Voltage	1NO-1NC 2NO 2NC	ALW29911D-②-③ ALW29920D-②-③ ALW29902D-②-③	AOLW29911D-②-③ AOLW29920D-②-③ AOLW29902D-②-③
Extended Lens with Full Shroud 	Transformer	1NO-1NC 2NO 2NC	ALFW2 ④ 11D-② ALFW2 ④ 20D-② ALFW2 ④ 02D-②	AOLFW2 ④ 11D-② AOLFW2 ④ 20D-② AOLFW2 ④ 02D-②
	Full Voltage	1NO-1NC 2NO 2NC	ALFW29911D-②-③ ALFW29920D-②-③ ALFW29902D-②-③	AOLFW29911D-②-③ AOLFW29920D-②-③ AOLFW29902D-②-③
ø29mm Mushroom Button 	Transformer	1NO-1NC 2NO 2NC	ALW3 ④ 11D-② ALW3 ④ 20D-② ALW3 ④ 02D-②	AOLW3 ④ 11D-② AOLW3 ④ 20D-② AOLW3 ④ 02D-②
	Full Voltage	1NO-1NC 2NO 2NC	ALW39911D-②-③ ALW39920D-②-③ ALW39902D-②-③	AOLW39911D-②-③ AOLW39920D-②-③ AOLW39902D-②-③
ø40mm Mushroom Button 	Transformer	1NO-1NC 2NO 2NC	ALW4 ④ 11D-② ALW4 ④ 20D-② ALW4 ④ 02D-②	AOLW4 ④ 11D-② AOLW4 ④ 20D-② AOLW4 ④ 02D-②
	Full Voltage	1NO-1NC 2NO 2NC	ALW49911D-②-③ ALW49920D-②-③ ALW49902D-②-③	AOLW49911D-②-③ AOLW49920D-②-③ AOLW49902D-②-③
Square Extended 	Transformer	1NO-1NC 2NO 2NC	ALQW2B ④ 11D-② ALQW2B ④ 20D-② ALQW2B ④ 02D-②	AOLQW2B ④ 11D-② AOLQW2B ④ 20D-② AOLQW2B ④ 02D-②
	Full Voltage	1NO-1NC 2NO 2NC	ALQW2B9911D-②-③ ALQW2B9920D-②-③ ALQW2B9902D-②-③	AOLQW2B9911D-②-③ AOLQW2B9920D-②-③ AOLQW2B9902D-②-③

② LED/Lens Color Codes

Color	Code
Amber	A
Green	G
Red	R
Blue	S
White	W
Yellow	Y

- 1. Mushroom lenses not available in yellow.
- 2. Yellow pushbutton comes with white LED.

③ Full Voltage Codes

Voltage	Code
6V AC/DC	6V
12V AC/DC	12V
24V AC/DC	24V
120V AC	120V
240V AC	240V

④ Transformer Voltage Codes

Voltage	Code
120VAC	126
240VAC	246
480VAC	486

- Transformers step down to 6V (use 6V LED).

- 1. In place of ②, specify the Lens Color Code (see table). Mushroom lenses not available in yellow.
- 2. In place of ③, specify the Full Voltage Code (lamp voltage) (see table).
- 3. In place of ④, specify the Transformer Voltage Code (see table).
- 4. For sub-assembly part numbers, see next page.
- 5. For accessories, see page 728.
- 6. For dimensions, see page 730.
- 7. Light is independent of switch position.
- 8. Yellow pushbutton comes with white LED.

Illuminated Pushbuttons (Sub-Assembled)



\*Not applicable for full voltage units

Operators

Style	Part Number	
	Momentary	Maintained
Extended	ALW-0600	AOLW-0600
Extended with Full Shroud	ALFW-0600	AOLFW-0600
ø29mm/ø40mm Mushroom	ALW3-0600	AOLW3-0600
Square/Extended	ALQW-2B0600	AOLQW-2B0600

Lamps

Style	Voltage	Part Number
LED	6V AC/DC	LSTD-6Ⓢ
	12V AC/DC	LSTD-1Ⓢ
	24V AC/DC	LSTD-2Ⓢ
	120V AC	LSTD-H2Ⓢ
	240V AC	LSTD-M4Ⓢ

- 1. In place of Ⓢ, specify the LED color code.
- 2. The LED contains a current-limiting resistor and a protection diode.

Lamp Circuit Components

Style	Application	Part Number
Long Lamp Holder	Used with Full-size Transformer and two contact blocks	TW-LH2
Lead Holder	Used with TW-LH2 holder when using four contact blocks and transformer	HW-LH3

Lenses

Style	Part Number	
	Standard	Engravable
Round Extended	ALW2LU-Ⓢ	ALW2BLU-Ⓢ
ø 29mm Mushroom Head*	ALW3LU-Ⓢ	ALW3BLU-Ⓢ
ø 40mm Mushroom Head*	ALW4LU-Ⓢ	ALW4BLU-Ⓢ
Square Extended	—	ALQW2BLU-Ⓢ

Ⓢ LED/Lens Color Codes



Color	Code	Color	Code
Amber	A	Blue	S
Green	G	White	W
Red	R	Yellow	Y

Yellow LED not available. Use white LED.

- 1. In place of Ⓢ, specify the lens color code from table on the bottom right.
- 2. \*Mushroom lens not available in yellow.
- 3. Standard lenses have ribbed pattern, Engravable lenses are smooth and include an engravable insert.

Illuminated Pushbuttons (Sub-Assembled) continued

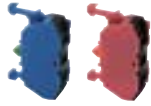
Contact Blocks

Style	Contacts	1NO	1NC
	Finger-Safe Spring-Up Terminal	HW-U10-F	HW-U01-F
		HW-U10R-F (early make)	HW-U01R-F (late break)
	Dummy Block	HW-DB	

- 1. Dummy blocks (no contacts) are used with an odd number of contact blocks.
- 2. Use of early and late break contacts creates a make before break function

Transformers/Full Voltage Modules

Style	Description	Part Number	
	Full Size Transformer		
	Finger-Safe	120V AC 240V AC 480V AC	TW-F126B TW-F246B TW-F486B
	Dummy Block with Full Voltage Adaptor	For use with odd number of contacts.	Finger-Safe HW-DA1FBN
Full Voltage Adaptor	For use with even number of contacts.	Finger-Safe TW-DA1FB	

 All Transformers step down to 6V (use 6V LED).

Switches & Pilot Devices

Signaling Lights

Relays & Sockets

Timers

Contactors

Terminal Blocks

Circuit Breakers



**Non-Illuminated Selector Switches (Assembled)**



**Assembled Selector Switches**

**A S W 3 (1) (L) 20 - 304**

**Function**

S: Selector Switch

**Series Designation**

W: TW Series

**Number of Positions**

- 2: 2-Position
- 3: 3-Position
- 4: 4-Position
- 5: 5-Position

**Spring Return Action**

Blank: Maintained

- 1: Spring return from Right (2 or 3 position)
- 2: Spring return from Left (2 or 3 position)
- 3: 2-Way spring return from Left and Right (3 position only)

**Circuit Number**

(Standard circuits shown on following pages and 720.)

**Contact Arrangement Code**

- 10: 1NO      01: 1NC
- 20: 2NO      02: 2NC
- 40: 4NO      04: 4NC
- 11: 1NO-1NC 22: 2NO-2NC



**Operator Style Code**

- Blank:      Knob Operator
- L:          Lever Operator
- K:          Key Operator

- 1. Use only when interpreting part numbers. Do not use for developing part numbers.
- 2. Custom contact configurations available.
- 3. Custom key removable codes available.
- 4. Portions of part number inside ( ) are optional.

Non-Illuminated Selector Switches (Assembled) continued

2-Position Selector Switches

Contact	Style				Part Number		
	Mounting	Operator Position			Maintained	Spring Return from Right	Spring Return from Left
		L	R				
1NO	1 2	0 0	X 0	Knob Lever Key	ASW210 ASW2L10 ASW2K10	ASW2110 ASW21L10 ASW21K10	ASW2210 ASW22L10 ASW22K10
1NC	1 2	X 0	0 0	Knob Lever Key	ASW201-116 ASW2L01-116 ASW2K01-116	ASW2101-116 ASW21L01-116 ASW21K01-116	ASW2201-116 ASW22L01-116 ASW22K01-116
1NO 1NC	1 2	X 0	0 X	Knob Lever Key	ASW211 ASW2L11 ASW2K11	ASW2111 ASW21L11 ASW21K11	ASW2211 ASW22L11 ASW22K11
2NO	1 2	0 0	X X	Knob Lever Key	ASW220 ASW2L20 ASW2K20	ASW2120 ASW21L20 ASW21K20	ASW2220 ASW22L20 ASW22K20
2NC	1 2	X X	0 0	Knob Lever Key	ASW202-104 ASW2L02-104 ASW2K02-104	ASW2102-104 ASW21L02-104 ASW21K02-104	ASW2202-104 ASW22L02-104 ASW22K02-104
2NO 2NC	1 2 3 4	0 X 0 X	X 0 X 0	Knob Lever Key	ASW222 ASW2L22 ASW2K22	ASW2122 ASW21L22 ASW21K22	ASW2222 ASW22L22 ASW22K22
2NO 2NC	1 2 3 4	0 0 X X	X X 0 0	Knob Lever Key	ASW222-111 ASW2L22-111 ASW2K22-111	ASW2122-111 ASW21L22-111 ASW21K22-111	ASW2222-111 ASW22L22-111 ASW22K22-111



Switches & Pilot Devices

Signaling Lights

Relays & Sockets

Timers

Contactors

Terminal Blocks

Circuit Breakers

Non-Illuminated Selector Switches (Assembled) continued

3-Position Selector Switches

Contact	Mounting	Style				Part Number							
		Operator Position				Maintained	Spring Return from Right	Spring Return from Left	Spring Return Two-Way				
		L	C	R									
2NO	1	X	0	0	Knob	ASW320	ASW3120	ASW3220	ASW3320				
	2	0	0	X						ASW3L20	ASW32L20	ASW33L20	
2NC	1	0	X	X	Knob	ASW302	ASW3102	ASW3202	ASW3302				
	2	X	X	0						ASW3L02	ASW32L02	ASW33L02	
2NO 2NC	1	X	0	0	Knob	ASW322	ASW3122	ASW3222	ASW3322				
	2	0	0	X						ASW3L22	ASW32L22	ASW33L22	
	3	0	X	X						ASW3K22	ASW31K22	ASW32K22	ASW33K22
	4	X	X	0									
2NO 2NC	1	X	0	X	Knob	ASW322-309	ASW3122-309	ASW3222-309	ASW3322-309				
	2	X	X	0						ASW3L22-309	ASW32L22-309	ASW33L22-309	
	3	0	X	0						ASW3K22-309	ASW31K22-309	ASW32K22-309	ASW33K22-309
	4	0	0	X									
2NO 2NC	1	0	X	0	Knob	ASW322-310	ASW3122-310	ASW3222-310	ASW3322-310				
	2	0	0	X						ASW3L22-310	ASW32L22-310	ASW33L22-310	
	3	0	X	0						ASW3K22-310	ASW31K22-310	ASW32K22-310	ASW33K22-310
	4	0	0	X									
4NO	1	X	0	0	Knob	ASW340	ASW3140	ASW3240	ASW3340				
	2	0	0	X						ASW3L40	ASW32L40	ASW33L40	
	3	X	0	0						ASW3K40	ASW31K40	ASW32K40	ASW33K40
	4	0	0	X									
4NC	1	0	X	X	Knob	ASW304	ASW3104	ASW3204	ASW3304				
	2	X	X	0						ASW3L04	ASW32L04	ASW33L04	
	3	0	X	X						ASW3K04	ASW31K04	ASW32K04	ASW33K04
	4	X	X	0									



- The truth table indicates the operating position of contact block when the operator is switched to that position.  
 X = On (closed contacts)  
 0 = Off (open contacts)  
 X—X = Overlapping Contacts: Remain on (closed contacts) when switch is moved between these two positions.
- All knob and lever selector switches come in black. Other colors are available by ordering the knob or lever separately.
- Every key selector switch uses an identical key. The key is removable in any maintained position.
- Custom contact configurations are available, see page 720.

4-Position Selector Switch

Contact	Mounting	Style					Maintained
		Operator Position					Part Number
		1	2	3	4		
2NO	1	X	0	0	0	Knob	ASW422-411
	2	0	X	0	0		
2NC	3	0	0	X	0	Lever	ASW4L22-411
	4	0	0	0	X		

5-Position Selector Switch

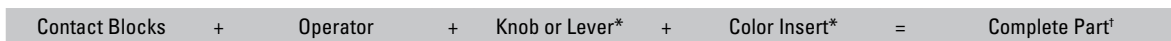

Contact	Mounting	Style						Maintained
		Operator Position						Part Number
		1	2	3	4	5		
2NO	1	X	0	0	0	0	Knob	ASW522-501
	2	0	X	0	0	0		
2NC	3	0	0	0	X	0	Lever	ASW5L22-501
	4	0	0	0	0	X		

Non-Illuminated Selector Switches (Sub-Assembled)



- 1. \*Not needed with key type switches.
- 2. †Knob type shown.

Operators

Style	Positions	Description	Part Number	
Knob/Lever 	2	Maintained	ASW200	
		Spring return from right	ASW2100	
		Spring return from left	ASW2200	
	3	Maintained, Cam 1 Maintained, Cam 2 Maintained, Cam 3		ASW300-1 ASW300-2 ASW300-3
			Spring return from right, Cam 1 Spring return from right, Cam 2	ASW3100-1 ASW3100-2
			Spring return from left, Cam 1 Spring return from left, Cam 2	ASW3200-1 ASW3200-2
		Spring return from left/right, Cam 1 Spring return from left/right, Cam 2	ASW3300-1 ASW3300-2	
		4	Maintained, Standard Cam	ASW400
			Maintained, Cam 1	ASW400-1
5	Maintained, Standard cam	ASW500		
	Maintained, Cam 1	ASW500-1		
Key 	2	Maintained	ASW2K00	
		Spring return from right	ASW21K00	
		Spring return from left	ASW22K00	
	3	Maintained, Cam 1 Maintained, Cam 2 Maintained, Cam 3		ASW3K00-1 ASW3K00-2 ASW3K00-3
			Spring return from right, Cam 1 Spring return from right, Cam 2	ASW31K00-1 ASW31K00-2
			Spring return from left, Cam 1 Spring return from left, Cam 2	ASW32K00-1 ASW32K00-2
		Spring return from left/right, Cam 1 Spring return from left/right, Cam 2	ASW33K00-1 ASW33K00-2	

- 1. Two keys are supplied with every key switch, all are keyed alike, and removable from any maintained position.
- 2. Locking rings are included with all operators. Order knobs, levers, and color inserts separately.
- 3. Different cams produce different contact actions. For details, see page 720.
- 4. Key switch operator supplied with black sleeve.

① Handle/Insert Color Codes

Color	Code
Black*	B
Blue	S
Green	G
Red	R
Yellow	Y
White†	W

- \*Color inserts not available in black.
- †Knob and lever not available in white.

Replacement Parts

Key Switch Black Sleeve	AKW2B-B
-------------------------	---------

Handles and Inserts

Style	Part Number
Knob 	ASWHHY-①
Lever 	ASWHHL-①
Color Insert 	TW-HC1-①

Contact Blocks

Style	Contacts	1NO	1NC
	Finger-Safe Spring-Up Terminal	HW-U10-F	HW-U01-F
		HW-U10R-F (early make)	HW-U01R-F (late break)
	Dummy Block	HW-DB	



- 1. Push rod color code:  
Green = NO contact block  
Red = NC contact block.
- 2. Dummy blocks (no contacts) are used with an odd number of contact blocks.

**Illuminated Selector Switches (Assembled)**



**Assembled Illuminated Selector Switches**

**A SL W 2 (2) 99 11 (D) - (103) - R - (24V)**

**Function**

SL: Illuminated Selector Switch

**Series Designation**

W: TW series

**Number of Positions**

2: 2-Position  
3: 3-Position

**Spring Return Action**

Blank: Maintained  
1: Spring return from Right  
2: Spring return from Left  
3: Two-Way spring return from Left and Right

**Illumination Circuit**

99: Full Voltage (lamp determines voltage)  
126: 120V AC Step Down Transformer  
246: 240V AC Step Down Transformer  
486: 480V AC Step Down Transformer

**Lamp Voltage**

(Full Voltage Units Only)

6V: 6V AC/DC  
12V: 12V AC/DC  
24V: 24V AC/DC  
120V: 120V AC  
240V: 240V AC

**Lens Color Code**

A: Amber  
G: Green  
R: Red  
S: Blue  
W: White  
Y: Yellow

**Contact Circuit Number**

Standard circuits are listed on the following pages and 720.

**Lamp Type**

D: LED Lamp

**Contact Arrangement**

10: 1NO	01: 1NC
20: 2NO	02: 2NC
40: 4NO	04: 4NC
11: 1NO-1NC	22: 2NO-2NC

1. Use only when interpreting part numbers. Do not use for developing part numbers.  
2. All transformers step down to 6V (use 6V lamp).

Illuminated Selector Switches(Assembled) continued

Illuminated 2-Position Selector Switches

Style				Lamp Circuit Type	Part Number		
Contact	Mounting	Operator Position			Maintained	Spring Return from Right	Spring Return from Left
		L	R				
1NO 1NC	1 2	0 X	X 0	Transformer Full Voltage	ASLW2 ① 11D-② ASLW29911D-②-③	ASLW21 ① 11D-② ASLW219911D-②-③	ASLW22 ① 11D-② ASLW229911D-②-③
2NO	1 2	0 0	X X	Transformer Full Voltage	ASLW2 ① 20D-② ASLW29920D-②-③	ASLW21 ① 20D-② ASLW219920D-②-③	ASLW22 ① 20D-② ASLW229920D-②-③
2NC	1 2	X X	0 0	Transformer Full Voltage	ASLW2 ① 02D-104-② ASLW29902D-104-②-③	ASLW21 ① 02D-104-② ASLW219902D-104-②-③	ASLW22 ① 02D-104-② ASLW229902D-104-②-③
2NO 2NC	1 2 3 4	0 X 0 X	X 0 X 0	Transformer Full Voltage	ASLW2 ① 22D-② ASLW29922D-②-③	ASLW21 ① 22D-② ASLW219922D-②-③	ASLW22 ① 22D-② ASLW229922D-②-③

① Transformer Voltage Codes

Voltage	Code
120VAC	126
240VAC	246
480VAC	486

Transformers step down to 6V (use 6V LED).

② LED/Lens Color Codes

Color	Code
Amber	A
Green	G
Red	R
Blue	S
White	W
Yellow	Y

Illuminated 3-Position Selector Switches, Maintained and Spring Return from Right

Style					Lamp Circuit Type	Part Number			
Contact	Mounting	Operator Position				Maintained	Spring Return From Right	Spring Return from Left	Spring Return Two-Way
		L	C	R					
2NO	1 2	X 0	0 0	0 X	Transformer Full Voltage	ASLW3 ① 20D-② ASLW39920D-②-③	ASLW31 ① 20D-② ASLW319920D-②-③	ASLW32 ① 20D-② ASLW329920D-②-③	ASLW33 ① 20D-② ASLW339920D-②-③
2NC	1 2	0 X	X X	X 0	Transformer Full Voltage	ASLW3 ① 02D-② ASLW39902D-②-③	ASLW31 ① 02D-② ASLW319902D-②-③	ASLW32 ① 02D-② ASLW329902D-②-③	ASLW33 ① 02D-② ASLW339902D-②-③
2NO 2NC	1 2 3 4	X 0 0 X	0 0 X X	0 X X 0	Transformer Full Voltage	ASLW3 ① 22D-② ASLW39922D-②-③	ASLW31 ① 22D-② ASLW319922D-②-③	ASLW32 ① 22D-② ASLW329922D-②-③	ASLW33 ① 22D-② ASLW339922D-②-③
2NO 2NC	1 2 3 4	X X 0 0	0 X X 0	X 0 0 X	Transformer Full Voltage	ASLW3 ① 22D-309-② ASLW39922D-309-②-③	ASLW31 ① 22D-309-② ASLW319922D-309-②-③	ASLW32 ① 22D-309-② ASLW329922D-309-②-③	ASLW33 ① 22D-309-② ASLW339922D-309-②-③
2NO 2NC	1 2 3 4	0 0 0 0	X 0 X 0	0 X 0 X	Transformer Full Voltage	ASLW3 ① 22D-310-② ASLW39922D-310-②-③	ASLW31 ① 22D-310-② ASLW319922D-310-②-③	ASLW32 ① 22D-310-② ASLW329922D-310-②-③	ASLW33 ① 22D-310-② ASLW339922D-310-②-③
4NO	1 2 3 4	X 0 X 0	0 0 0 0	0 X 0 X	Transformer Full Voltage	ASLW3 ① 40D-② ASLW39940D-②-③	ASLW31 ① 40D-② ASLW319940D-②-③	ASLW32 ① 40D-② ASLW329940D-②-③	ASLW33 ① 40D-② ASLW339940D-②-③
4NC	1 2 3 4	0 X 0 X	X X X X	X 0 X 0	Transformer Full Voltage	ASLW3 ① 04D-② ASLW39904D-②-③	ASLW31 ① 04D-② ASLW319904D-②-③	ASLW32 ① 04D-② ASLW329904D-②-③	ASLW33 ① 04D-② ASLW339904D-②-③

- 1. In place of ①, specify the Transformer Voltage Code.
- 2. In place of ②, specify the Lens/LED Color Code.
- 3. In place of ③, specify the Full Voltage Code.
- 4. For custom contact configurations, see page 720.
- 5. Light is independent of switch position.
- 6. Yellow selector switch comes with white LED.

③ Full Voltage Codes

Voltage	Code
6V AC/DC	6V
12V AC/DC	12V
24V AC/DC	24V
120V AC	120V
240V AC	240V

Switches & Pilot Devices

Signaling Lights

Relays & Sockets

Timers

Contactors

Terminal Blocks

Circuit Breakers



### Illuminated Selector Switches (Sub-Assembled)

Transformer\* + Contact Block + Operator + Lamp/Lead Holder<sup>1</sup> + LED + Lens = Complete Part



 \*Full voltage units use a full voltage adaptor TW-DA1FB (even number of blocks) OR HW-DA1FBN (odd number of blocks) instead of a transformer.  
<sup>1</sup>Lamp holder is not included with operators, order separately.

#### Operators

Style	Positions	Description	Part Number
	2	Maintained	ASLW200
		Spring return from right	ASLW2100
		Spring return from left	ASLW2200
	3	Maintained, cam 1	ASLW300-1
		Maintained, cam 2	ASLW300-2
		Maintained, cam 3	ASLW300-3
	Spring return from right, cam 1	ASLW3100-1	
	Spring return from right, cam 2	ASLW3100-2	
	Spring return from left, cam 1	ASLW3200-1	
	Spring return from left, cam 2	ASLW3200-2	
	Spring return from left/right, cam 1	ASLW3300-1	
Spring return from left/right, cam 2	ASLW3300-2		

 Different cams produce different contact action. For details, see Contact Arrangements on page 720.

#### Lenses (Knobs)

Style	Part Number
Knob  	ASLWLU-②

 In place of ②, specify the lens color code from table.

#### Lamps

Style	Voltage	Part Number
	6V AC/DC	LSTD-6②
	12V AC/DC	LSTD-1②
	24V AC/DC	LSTD-2②
	120V AC	LSTD-H2②
	240V AC	LSTD-M4②

 1. In place of ②, specify the LED color code.  
 2. The LED contains a current-limiting resistor and a protection diode.



#### ② LED/Lens Color Codes

Color	Code
Amber	A
Green	G
Red	R
Blue	S
White	W
Yellow	Y

 Yellow LED not available. Use white LED

**Illuminated Selector Switches (Sub-Assembled) continued**

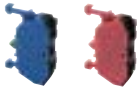
**Contact Blocks**

Style	Contacts	1NO	1NC
	Finger-Safe Spring-Up Terminal	HW-U10-F	HW-U01-F
		HW-U10R-F (early make)	HW-U01R-F (late break)
	Dummy Block	HW-DB	

-  1. Dummy blocks (no contacts) are used with an odd number of contact blocks.
- 2. Use of early and late break contacts creates a make before break function

**Lamp Circuit Components**

Style	Application	Part Number
Short Lamp Holder 	<b>Used with</b> full voltage adaptor and one contact block	TW-LH1
Long Lamp Holder 	<b>Used with</b> Full-size Transformer and two contact blocks	TW-LH2
Lead Holder 	<b>Used with</b> TW-LH2 holder when using four contact blocks and full size transformer	HW-LH3

**Transformers/Full Voltage Modules**

Style	Description	Part Number
Full Size Transformer 	120V AC	TW-F126B
	240V AC	TW-F246B
	480V AC	TW-F486B
Dummy Block with Full Voltage Adaptor	 For use with odd number of contacts. Finger-Safe	HW-DA1FBN
Full Voltage Adaptor	 For use with even number of contacts. Finger-Safe	TW-DA1FB

-  All Transformers step down to 6V (use 6V lamp).



### Contact Arrangement Charts

#### How to Read Contact Arrangement Charts

To determine contact block mounting position, first make sure the selector switch is oriented as shown on the right

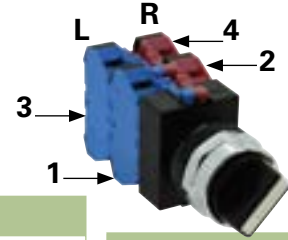

#### Contact Arrangement

Type and quantity of switch contacts

#### Circuit Number

\* N/D = No designation required

#### Contact Block Mounting Position

Position or mounting contact blocks on operator.

#### Operator Position

Truth table indicates the operating position of contact block when operator is switched to that position (X - closed, O - open).

#### Contact Block Part Number

Part number to use when ordering sub-assembly contact blocks, as required for use with corresponding mounting position

#### Contact Arrangement Chart: 2-Position Selector Switches

Style		Mounting Position	Operator Position		Contact Block Part Number	Description	Operator Part Number		
Contact	Circuit Number		L	R			Maintained	Spring Ret. from Rt.	Spring Ret. from Lt.
1NO	N/D	1	0	X	HW-U10-F	Knob/Lever Key	ASW200 ASW2K00	ASW2100 ASW21K00	ASW2200 ASW22K00
		2	0	0	HW-DB	Illuminated Knob	ASLW200	ASLW2100	ASLW2200
1NC	116	1	X	0	HW-U01-F	Knob/Lever Key	ASW200 ASW2K00	ASW2100 ASW21K00	ASW2200 ASW22K00
		2	0	0	HW-DB	Illuminated Knob	ASLW200	ASLW2100	ASLW2200
1NO 1NC	N/D	1	0	X	HW-U10-F	Knob/Lever Key	ASW200 ASW2K00	ASW2100 ASW21K00	ASW2200 ASW22K00
		2	X	0	HW-U01-F	Illuminated Knob	ASLW200	ASLW2100	ASLW2200
1NO-EM 1NC-LB	103	1	X	0	HW-U01-F	Knob/Lever Key	ASW200 ASW2K00	ASW2100 ASW21K00	ASW2200 ASW22K00
		2	0	X	HW-U10-F	Illuminated Knob	ASLW200	ASLW2100	ASLW2200
1NO-EM 1NC-LB	600	1	0	X	HW-U10R-F	Knob/Lever Key	ASW200 ASW2K00	ASW2100 ASW21K00	ASW2200 ASW22K00
		2	X	0	HW-U01R-F	Illuminated Knob	ASLW200	ASLW2100	ASLW2200
1NO-EM 1NC-LB	601	1	X	0	HW-U01R-F	Knob/Lever Key	ASW200 ASW2K00	ASW2100 ASW21K00	ASW2200 ASW22K00
		2	0	X	HW-U10R-F	Illuminated Knob	ASLW200	ASLW2100	ASLW2200
2NO	N/D	1	0	X	HW-U10-F	Knob/Lever Key	ASW200 ASW2K00	ASW2100 ASW21K00	ASW2200 ASW22K00
		2	0	X	HW-U10-F	Illuminated Knob	ASLW200	ASLW2100	ASLW2200
2NC	104	1	X	0	HW-U01-F	Knob/Lever Key	ASW200 ASW2K00	ASW2100 ASW21K00	ASW2200 ASW22K00
		2	X	0	HW-U01-F	Illuminated Knob	ASLW200	ASLW2100	ASLW2200
2NO 2NC	N/D	1	0	X	HW-U10-F	Knob/Lever Key Illuminated Knob	ASW200 ASW2K00 ASLW200	ASW2100 ASW21K00 ASLW2100	ASW2200 ASW22K00 ASLW2200
		2	X	0	HW-U01-F				
		3	0	X	HW-U10-F				
		4	X	0	HW-U01-F				
2NO 2NC	111	1	0	X	HW-U10-F	Knob/Lever Key Illuminated Knob	ASW200 ASW2K00 ASLW200	ASW2100 ASW21K00 ASLW2100	ASW2200 ASW22K00 ASLW2200
		2	0	X	HW-U10-F				
		3	X	0	HW-U01-F				
		4	X	0	HW-U01-F				

1. NO-EM, NC-LB = Early Make, Late Break.  
N/D = No circuit number designation required in assembled selector switch part number.  
2. X = On (closed contacts) O = Off (Open contacts)

Contact Arrangement Chart: 3-Position Selector Switches

Style		Mounting Position	Operator Position			Contact Block Part Number	Description	Operator Part Number				
Contact	Circuit Number		L	C	R			Maintained	Spring Return from Right	Spring Return from Left	Two-Way	
1NO 1NC	202	1	X	0	0	HW-U10-F	Knob/Lever Key	ASW300-1 ASW3K00-1 ASLW300-1	ASW3100-1 ASW31K00-1 ASLW3100-1	ASW3200-1 ASW32K00-1 ASLW3200-1	ASW3300-1 ASW33K00-1 ASLW3300-1	
		2	X-X	0	0	HW-U01-F	Illuminated Knob					
	203	1	0	X-X	0	HW-U01-F	Knob/Lever Key	ASW300-1 ASW3K00-1 ASLW300-1	ASW3100-1 ASW31K00-1 ASLW3100-1	ASW3200-1 ASW32K00-1 ASLW3200-1	ASW3300-1 ASW33K00-1 ASLW3300-1	
		2	0	0	X	HW-U10-F	Illuminated Knob					
	302	1	X	0	X	HW-U10-F	Knob/Lever Key	ASW300-2 ASW3K00-2 ASLW300-2	ASW3100-2 ASW31K00-2 ASLW3100-2	ASW3200-2 ASW32K00-2 ASLW3200-2	ASW3300-2 ASW33K00-2 ASLW3300-2	
		2	X-X	0	0	HW-U01-F	Illuminated Knob					
	303	1	0	X	0	HW-U01-F	Knob/Lever Key	ASW300-2 ASW3K00-2 ASLW300-2	ASW3100-2 ASW31K00-2 ASLW3100-2	ASW3200-2 ASW32K00-2 ASLW3200-2	ASW3300-2 ASW33K00-2 ASLW3300-2	
		2	0	0	X	HW-U10-F	Illuminated Knob					
	2NO	N/D	1	X	0	0	HW-U10-F	Knob/Lever Key	ASW300-1 ASW3K00-1 ASLW300-1	ASW3100-1 ASW31K00-1 ASLW3100-1	ASW3200-1 ASW32K00-1 ASLW3200-1	ASW3300-1 ASW33K00-1 ASLW3300-1
			2	0	0	X	HW-U10-F	Illuminated Knob				
		301	1	X	0	X	HW-U10-F	Knob/Lever Key	ASW300-2 ASW3K00-2 ASLW300-2	ASW3100-2 ASW31K00-2 ASLW3100-2	ASW3200-2 ASW32K00-2 ASLW3200-2	ASW3300-2 ASW33K00-2 ASLW3300-2
			2	0	0	X	HW-U10-F	Illuminated Knob				
2NC	304	1	0	X	0	HW-U01-F	Knob/Lever Key	ASW300-2 ASW3K00-2 ASLW300-2	ASW3100-2 ASW31K00-2 ASLW3100-2	ASW3200-2 ASW32K00-2 ASLW3200-2	ASW3300-2 ASW33K00-2 ASLW3300-2	
		2	X-X	0	0	HW-U01-F	Illuminated Knob					
	N/D	1	0	X-X	0	HW-U01-F	Knob/Lever Key	ASW300-1 ASW3K00-1 ASLW300-1	ASW3100-1 ASW31K00-1 ASLW3100-1	ASW3200-1 ASW32K00-1 ASLW3200-1	ASW3300-1 ASW33K00-1 ASLW3300-1	
		2	X-X	0	0	HW-U01-F	Illuminated Knob					
2NO 2NC	N/D	1	X	0	0	HW-U10-F	Knob/Lever Key Illuminated Knob	ASW300-1 ASW3K00-1 ASLW300-1	ASW3100-1 ASW31K00-1 ASLW3100-1	ASW3200-1 ASW32K00-1 ASLW3200-1	ASW3300-1 ASW33K00-1 ASLW3300-1	
		2	0	0	X	HW-U10-F						
		3	0	X-X	0	HW-U01-F						
		4	X-X	0	0	HW-U01-F						
	210	1	0	X	X	HW-U01-F	Knob/Lever Key Illuminated Knob	ASW300-1 ASW3K00-1 ASLW300-1	ASW3100-1 ASW31K00-1 ASLW3100-1	ASW3200-1 ASW32K00-1 ASLW3200-1	ASW3300-1 ASW33K00-1 ASLW3300-1	
		2	0	0-X	0	HW-U10-F						
		3	0	X-X	0	HW-U01-F						
		4	0	0	X	HW-U10-F						
	308	1	X	0	X	HW-U10-F	Knob/Lever Key Illuminated Knob	ASW300-2 ASW3K00-2 ASLW300-2	ASW3100-2 ASW31K00-2 ASLW3100-2	ASW3200-2 ASW32K00-2 ASLW3200-2	ASW3300-2 ASW33K00-2 ASLW3300-2	
		2	X-X	0	0	HW-U01-F						
		3	X	0	X	HW-U10-F						
		4	X-X	0	0	HW-U01-F						
	309	1	X	0	X	HW-U10-F	Knob/Lever Key Illuminated Knob	ASW300-2 ASW3K00-2 ASLW300-2	ASW3100-2 ASW31K00-2 ASLW3100-2	ASW3200-2 ASW32K00-2 ASLW3200-2	ASW3300-2 ASW33K00-2 ASLW3300-2	
		2	X-X	0	0	HW-U01-F						
		3	0	X	0	HW-U01-F						
		4	0	0	X	HW-U10-F						
310	1	0	X	0	HW-U01-F	Knob/Lever Key Illuminated Knob	ASW300-2 ASW3K00-2 ASLW300-2	ASW3100-2 ASW31K00-2 ASLW3100-2	ASW3200-2 ASW32K00-2 ASLW3200-2	ASW3300-2 ASW33K00-2 ASLW3300-2		
	2	0	0	X	HW-U10-F							
	3	0	X	0	HW-U01-F							
	4	0	0	X	HW-U10-F							

1. Each operator sub-assembly is available as a "-1" and a "-2" for 3-position selector switches. The internal cam of a "-1" is different from that of a "-2". This results in designated combinations of open and closed contacts in the various operator positions.
2. N/D = No circuit number designation required in assembled part number.
3. X = On (closed contacts) 0 = Off (open contacts). X-X Overlapping contacts remain on (closed) when switch is moved between these two positions.

Switches & Pilot Devices

Signaling Lights

Relays & Sockets

Timers

Contactors

Terminal Blocks

Circuit Breakers

**Contact Arrangement Chart: 3-Position Selector Switches**

Style		Mounting Position	Operator Position			Contact Block Part Number	Description	Operator Part Number			
Contact	Circuit Number		L	C	R			Maintained	Spring Return from Right	Spring Return from Left	Two-Way
4NO	N/D	1	X	0	0	HW-U10-F	Knob/Lever Key Illuminated Knob	ASW300-1 ASW3K00-1 ASLW300-1	ASW3100-1 ASW31K00-1 ASLW3100-1	ASW3200-1 ASW32K00-1 ASLW3200-1	ASW3300-1 ASW33K00-1 ASLW3300-1
		2	0	0	X	HW-U10-F					
		3	X	0	0	HW-U10-F					
		4	0	0	X	HW-U10-F					
	305	1	X	0	X	HW-U10-F	Knob/Lever Key Illuminated Knob	ASW300-2 ASW3K00-2 ASLW300-2	ASW3100-2 ASW31K00-2 ASLW3100-2	ASW3200-2 ASW32K00-2 ASLW3200-2	ASW3300-2 ASW33K00-2 ASLW3300-2
		2	0	0	X	HW-U10-F					
		3	X	0	X	HW-U10-F					
		4	0	0	X	HW-U10-F					
4NC	N/D	1	0	X	X	HW-U01-F	Knob/Lever Key Illuminated Knob	ASW300-1 ASW3K00-1 ASLW300-1	ASW3100-1 ASW31K00-1 ASLW3100-1	ASW3200-1 ASW32K00-1 ASLW3200-1	ASW3300-1 ASW33K00-1 ASLW3300-1
		2	X	X	0	HW-U01-F					
		3	0	X	X	HW-U01-F					
		4	X	X	0	HW-U01-F					
	314	1	0	X	0	HW-U01-F	Knob/Lever Key Illuminated Knob	ASW300-2 ASW3K00-2 ASLW300-2	ASW3100-2 ASW31K00-2 ASLW3100-2	ASW3200-2 ASW32K00-2 ASLW3200-2	ASW3300-2 ASW33K00-2 ASLW3300-2
		2	X	X	0	HW-U01-F					
		3	0	X	0	HW-U01-F					
		4	X	X	0	HW-U01-F					

- 1. Each operator sub-assembly is available as a "-1" and a "-2" for 3-position selector switches. The internal cam of a "-1" is different from that of a "-2". This results in designated combinations of open and closed contacts in the various operator positions.
- 2. N/D = No circuit number designation required in assembled part number.
- 3. X = On (closed contacts) 0 = Off (open contacts). X-X Overlapping contacts remain on (closed) when switch is moved between these two positions.

### Custom Selector Switch Building Guide

To build a custom selector switch, follow these steps.

#### Step 1

How many positions of the switch are needed?

# of positions  
(2, 3, 4, 5)

#### Step 2

How many contacts should there be?

# of isolated contacts  
(maximum 6)

#### Mounting Positions

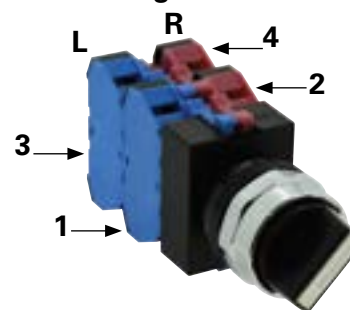

#### Step 3

Fill in the Truth Table

(X = closed, 0 = open)

		Knob Position				
		1	2	3	4	5
Contacts	1					
	2					
	3					
	4					
	5					
	6					

#### Step 4

If building a 2 position selector, skip this step. (2 position selectors have only one cam)

If building a 3, 4, or 5 position selector, determine appropriate cam as follows:

- Look at Row 1 from above table and locate an identical row in the operator truth tables (See next page).
- Repeat for all rows. The user must find one operator that contains all rows from above table.
- Record the operator cam version.

#### Step 5

Build by placing appropriate contact in appropriate mounting position for each desired row on operator cam truth table. "L" and "R" refer to mounting on left or right side of operator as viewed from the front of the panel.

#### Step 6

Develop an assembly part number (if necessary) as follows: follow standard numbering nomenclature for selector switches (see pages 712 or 716. In place of the "Circuit Number" indicate the cam number and contact arrangement as such ASW322-3-OELCXX, where "3" is the cam number, and contact arrangement "OELCXX" calls out individual contact mounting locations in order (see diagram above). O=NO, C=NC, E=NO-EM, L=NC-LB, X= no contact. Part number must designate all 6 possible mounting locations.



Caution: Before putting any custom selector switch into use, the user should use an ohmmeter to test for desired performance.

1. For Operator Truth Tables, see next page.

Operator Truth Tables

Use the following tables to build custom selector switches.

2 Position Selector Switches

	Contact	Mounting Position	Operator Position	
			Left	Right
			ASW200 ASLW200 ASW2K00	HW-U10-F (NO)
R	0	X		
HW-U01-F (NC)	L	X		0
	R	X		0
HW-U10R-F (NO-EM)	L	0		X
	R	0		X
HW-U01R-F (NC-LB)	L	X	0	
	R	X	0	

3 Position Selector Switches

	Contact	Mounting Position	Operator Position		
			Left	Center	Right
			ASW300-1 ASW3K00-1 ASLW300-1	HW-U10-F (NO)	L
R	0	0			X
HW-U01-F (NC)	L	0		X	X
	R	X		X	0
HW-U10R-F (NO-EM)	L	X		0	0
	R	0		0	X
HW-U01R-F (NC-LB)	L	0	X	X	
	R	X	X	0	

	Contact	Mounting Position	Operator Position		
			Left	Center	Right
			ASW300-2 ASW3K00-2 ASLW300-2	HW-U10-F (NO)	L
R	0	0			X
HW-U01-F (NC)	L	0		X	0
	R	X		X	0
HW-U10R-F (NO-EM)	L	X		0	X
	R	0		0	X
HW-U01R-F (NC-LB)	L	0	X	0	
	R	X	X	0	

	Contact	Mounting Position	Operator Position		
			Left	Center	Right
			ASW300-3 ASW3K00-3 ASLW300-3	HW-U10-F (NO)	L
R	0	0			X
HW-U01-F (NC)	L	0		X	0
	R	0		X	0
HW-U10R-F (NO-EM)	L	X		0	X
	R	X		0	X
HW-U01R-F (NC-LB)	L	0	X	X	
	R	X	X	0	

4 Position Selector Switches

	Contact	Mounting Position	Operator Position			
			1	2	3	4
			ASW400	HW-U10-F (NO)	L	X
R	0	X			0	0
HW-U01-F (NC)	L	0		X	X	X
	R	X		0	X	X
HW-U10R-F (NO-EM)	L	X		0	0	0
	R	0		X	0	0
HW-U01R-F (NC-LB)	L	0	X	X	X	
	R	X	0	X	X	

	Contact	Mounting Position	Operator Position			
			1	2	3	4
			ASW400-1	HW-U10-F (NO)	L	X
R	0	0			0	X
HW-U01-F (NC)	L	0		0	X	0
	R	0		X	0	0
HW-U10R-F (NO-EM)	L	X		X	0	X
	R	X		0	X	X
HW-U01R-F (NC-LB)	L	0	X	X	X	
	R	X	X	X	0	

5 Position Selector Switches

	Contact	Mounting Position	Operator Position				
			1	2	3	4	5
			ASW500	HW-U10-F (NO)	L	X	0
R	0	X			0	0	0
HW-U01-F (NC)	L	0		0	X	X	X
	R	0		0	0	X	X
HW-U10R-F (NO-EM)	L	X		0	0	0	0
	R	0		X	0	0	0
HW-U01R-F (NC-LB)	L	0	X	X	X	X	
	R	X	0	X	X	X	

	Contact	Mounting Position	Operator Position				
			1	2	3	4	5
			ASW500-1	HW-U10-F (NO)	L	X	0
R	0	0			0	0	X
HW-U01-F (NC)	L	0		0	0	X	0
	R	0		X	0	0	0
HW-U10R-F (NO-EM)	L	X		X	X	0	X
	R	X		0	X	X	X
HW-U01R-F (NC-LB)	L	0	X	X	X	X	
	R	X	X	X	X	0	

Nameplates – TW Series

Faceplates

	NWAL	NWAQL	NWAS	EMERGENCY STOP
	Part Number			
Nameplate (blank)	NWAL-OB (black) NWAL-OR (red)	NWAQL-OB (black) NWAQL-OR (red)	NWAS-OB	NWAR-0
Nameplate (engraved)	NWAL-⓪	NWAQL-⓪	NWAS-⓪	NWAR-27†

- 1. In place of ⓪, insert either the Standard Legend Code from table below or custom engraving delimited by " ".
- 2. Standard engravings are available at no charge.
- 3. NWAR-27 comes marked "Emergency Stop" as shown in drawing.

Standard Legend Codes

Pushbuttons				Pushbuttons/Selector Switches				Selector Switches	
Legend	Code	Legend	Code	Legend	Code	Legend	Code	Legend	Code
AUTO	101	OPEN	116	AUTO-MAN	201			AUTO-MAN-OFF	301
CLOSE	102	OUT	117	CLOSE-OPEN	202			AUTO-OFF-MAN	302
DOWN	103	RAISE	118	DOWN-UP	203			CLOSE-OFF-OPEN	303
EMERG.STOP	104	RESET	119	FAST-SLOW	204			DOWN-OFF-SLOW	304
FAST	105	REVERSE	120	FOR-REV	205	REV-FOR	216	FAST-OFF-SLOW	305
FORWARD	106	RUN	121	HAND-AUTO	206	RUN-JOG	217	FOR-OFF-REV	306
HAND	107	SLOW	122	HIGH-LOW	207	RUN-SAFE	218	LEFT-OFF-RIGHT	307
HIGH	108	START	123	JOG-RUN	208	SAFE-RUN	219	LOWER-OFF-RAISE	308
IN	109	STOP	124	LEFT-RIGHT	209	SAFE-RUN	219	OFF-MAN-AUTO	309
INCH	110	STOP	125	LOWER-RAISE	210	SLOW-FAST	220	OFF-SLOW-FAST	310
JOG	111	TEST	126	MAN-AUTO	211	START-STOP	221	OFF-1-2	311
LOW	112	UP	127	OFF-ON	212	STOP-START	222	OPEN-OFF-CLOSE	312
LOWER	113	I (Int'l On)	150	ON-OFF	213	UP-DOWN	223	SLOW-OFF-FAST	313
OFF	114	O (Int'l Off)	151	OPEN-CLOSE	214			SUMMER-OFF-WINTER	314
ON	115	EMO	152	RAISE-LOWER	215			UP-OFF-DOWN	315
								1-OFF-2	316
								HAND-OFF-AUTO	317

- 1. To order engraved nameplates, add legend code to nameplate part number. Character height based on the number of characters and size of nameplate. Standard character size is 3/16".
- 2. Nameplates with standard legends are the same list price as blank nameplates.

Nameplate Order Form on next page.

**Custom Engraved Nameplates Order Form – TW Series**

Copy this order form and use it to specify Letter Height, Custom Engravings, Location of Engraving on Nameplate, and Quantity Desired. To ensure engraving accuracy, fax it to your IDEC representative. or Distributor.

Your Company Name: \_\_\_\_\_ IDEC Rep/Distributor Contact: \_\_\_\_\_  
 Your Name: \_\_\_\_\_ PO number (if known): \_\_\_\_\_  
 Telephone: \_\_\_\_\_ IDEC Rep/Distributor Phone: \_\_\_\_\_  
 Fax & Email: \_\_\_\_\_ IDEC Rep/Distributor Fax & Email: \_\_\_\_\_

**NWAL**

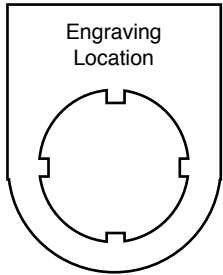

**Step 1.**

Choose Letter Size - 7/64" or 1/8".

Check the box for the letter size you want. Then write your lettering in box below checkboxes. Note: 1/8" size letters cannot exceed 9 characters.

7/64" Letter Size

11 characters max (for 7/64" size letters)

1/8" Letter Size

9 characters max (for 1/8" size letters)

**Step 2.**

Specify Quantity.

Enter the number of nameplates desired in the box on the right.

**Qty**

1 2 3 4 5 6 7 8 9 10 11

**Sample Letter Sizes**

7/64" Letters: A B C D

1/8" Letters: A B C D

**NWAQL**

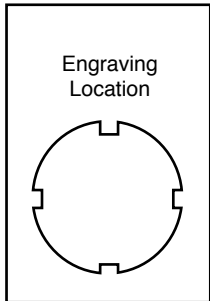

**Step 1.**

Choose Letter Size - 7/64" or 1/8".

Check the box for the letter size you want. Then write your lettering in box below checkboxes. Note: 1/8" size letters cannot exceed 9 characters.

7/64" Letter Size

11 characters max (for 7/64" size letters)

1/8" Letter Size

9 characters max (for 1/8" size letters)

**Step 2.**

Specify Quantity.

Enter the number of nameplates desired in the box on the right.

**Qty**

1 2 3 4 5 6 7 8 9 10 11

**Sample Letter Sizes**

7/64" Letters: A B C D

1/8" Letters: A B C D

**NWAS**

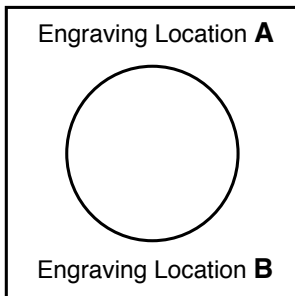

**Step 1.**

Choose Letter Size - 1/8" or 3/32".

Check the box for the letter size you want. Then write your lettering in box below checkboxes. Note: 1/8" size letters cannot exceed 14 characters.

3/32" Letter Size

20 characters max (for 3/32" size letters)

1/8" Letter Size

14 characters max (for 1/8" size letters)

**Step 2.**

Specify Quantity.

Enter the number of nameplates desired in the box on the right.

**Qty**

**Step 3.**

Specify Location.

Enter the location of engraving (A or B), in the box on the right.

**Location**

**Sample Letter Sizes**

3/32" Letters: A B C D

1/8" Letters: A B C D

1 2 3 4 5 6 7 8 9 10 11 12 13 14 15 16 17 18 19 20

Switches & Pilot Devices

Signaling Lights

Relays & Sockets

Timers

Contactors

Terminal Blocks

Circuit Breakers

Switch Engraving Order Form – TW Series

Copy this order form and use it to specify Letter Height, Maximum Number of Lines and Text to be engraved.

To ensure engraving accuracy, fax it to your IDEC representative or Distributor.

Your Company: \_\_\_\_\_  
 Name: \_\_\_\_\_  
 Address: \_\_\_\_\_  
 PO: \_\_\_\_\_

Telephone: \_\_\_\_\_  
 Fax: \_\_\_\_\_  
 Email: \_\_\_\_\_  
 Part Number to be Engraved: \_\_\_\_\_

Please check one of the boxes below to indicate your choice of engraving options:



ø29mm, ø40mm Mushroom Head

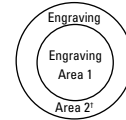

	# of Lines	Letter Height	Max. Characters Per Line
<input type="checkbox"/>	1	5/32	6
<input type="checkbox"/>		1/8	6
<input type="checkbox"/>	2	5/32	6
<input type="checkbox"/>		1/8	5
<input type="checkbox"/>	3	1/8	6
<input type="checkbox"/>	4	3/32	5

	# of Lines	Letter Height	Max. Characters Per Line
<input type="checkbox"/>	1	5/32	5
<input type="checkbox"/>		1/8	6
<input type="checkbox"/>	2	5/32	5
<input type="checkbox"/>		1/8	6
<input type="checkbox"/>	3	1/8	5
<input type="checkbox"/>	4	3/32	5

		# of Lines	Letter Height	Max. Characters Per Line
<input type="checkbox"/>	Engraving Area 1	1	5/32	5
<input type="checkbox"/>			1/8	5
<input type="checkbox"/>	Engraving Area 2	1	5/32	7
<input type="checkbox"/>			1/8	7



- Above mentioned specifications hold true for standard size pushbuttons (round and square).
- \*Engraving Area 2 can be engraved for 40mm mushroom Head non-Illuminated push button only.
- Engraving is done on the button itself for non-Illuminated push buttons and on marking plate for illuminated push buttons and pilot lights.
- Please enter text exactly how you want it engraved, take care to emphasize capital or small letters.

Enter text to be engraved:

Line 1: \_\_\_\_\_  
 Line 2: \_\_\_\_\_  
 Line 3: \_\_\_\_\_  
 Line 4: \_\_\_\_\_

Sample Letter Sizes

1/8 Letters: **OPEN**

5/32 Letters: **OPEN**

For IDEC Internal Use Only:

Work Order #: \_\_\_\_\_

Switches & Pilot Devices

Signaling Lights

Relays & Sockets

Timers

Contactors

Terminal Blocks

Circuit Breakers



Accessories

TW Series Accessories

Item	Appearance	Description/Usage		Part Number
Lamp Removal Tool		Rubber tool used to install or remove LED's		OR-55
Contact Block Remover		Used to remove contact blocks, transformers, lenses, and adaptors. Can also be used to determine panel thickness adjustment.		TW-KC1
Nut Locking Wrench		Used in OR-14 locking wrench to tighten locking nuts inside square bezel		TW-KQ2
Metal Bezel		Chrome plated bezels tighten onto operator (replacement for damaged bezels)	Standard octagonal units (chrome-pl.)	AW-R8
			Full shroud octagonal units (chrome-pl.)	AW-RF8
			Full shroud mushroom head units Ø 40mm	AW-G4
Plastic Bezel		Black plastic bezels for square buttons (replacement for damaged bezels)	Round flush units (black plastic)	AW-RP1B
			Round extended units (black plastic)	AW-FP1B
			Square units (black plastic)	AW-Q1B
			Square units with full shroud (black plastic)	AW-QF1B
Boot/Cover		Used to cover and protect pushbuttons	Waterproof lens cover for square pilot lights	APW00LN
			Waterproof lens cover for square illuminated buttons	APW00L
			Clear boot for round flush units	OC-31
			Clear boot for round extended units	OC-32
			*In place of asterisk, specify <b>Rubber Boot</b> color: <b>B</b> (black), <b>G</b> (green), <b>R</b> (red), <b>Y</b> (yellow) - (nitril rubber)	OCW-11*
Anti-Rotation Ring		Ring to prevent operator base from rotating in the mounting hole. Used when nameplate is not used		OGL-31
Mounting Hole Plug		Black rubber plug fills unused mounting holes in panel.		OB-31
Metallic Mounting Hole Plug		For plugging unused mounting holes in the panel. Tighten the attached locking ring to a torque of 12 kfg-cm maximum Degree of protection: IP66		LW9Z-BM
Replacement Keys		Replacement keys (#0)		TW-SK
Replacement Black Sleeve for Keyswitch				AKW2B-B

Item	Appearance	Description/Usage		Part Number													
Metal Button Guard		Used on flush buttons to prevent inadvertent actuation		OLW-C													
Terminal Tab Adaptor		Quick- connect terminals	#250 (17/64" x 3/64") single tab	TW-FA4													
Lock-out Adaptor		Used to provide lock-out protection for pushbuttons and knob selector switches: <ul style="list-style-type: none"> <li>Up to Ø 40mm mushroom head size (Padlock not included.)</li> </ul> Not applicable for e-stops.		HW9Z-KL1													
22mm to 30mm Adaptor		Used to mount TW series control unit (except square units) Ø 7/8" (22mm) into a Ø 1-13/64" (30mm) panel cut-out.		TWN-A1R8													
Contact Blocks (with side entry)		These contacts are applicable for wires terminated by ring, fork, <b>not recommended for bare wire connections.</b>	<table border="1"> <thead> <tr> <th></th> <th>1NC</th> <th>1NO</th> </tr> </thead> <tbody> <tr> <td>HW-U01</td> <td>HW-U01-MAU</td> <td>HW-U10</td> </tr> <tr> <td>HW-U01R</td> <td>HW-U01R-MAU</td> <td>HW-U10R</td> </tr> <tr> <td>HW-U01R-MAU (with side entry)</td> <td>HW-U10R-MAU (with side entry)</td> <td></td> </tr> </tbody> </table>				1NC	1NO	HW-U01	HW-U01-MAU	HW-U10	HW-U01R	HW-U01R-MAU	HW-U10R	HW-U01R-MAU (with side entry)	HW-U10R-MAU (with side entry)	
				1NC	1NO												
HW-U01	HW-U01-MAU	HW-U10															
HW-U01R	HW-U01R-MAU	HW-U10R															
HW-U01R-MAU (with side entry)	HW-U10R-MAU (with side entry)																
Contact Blocks (without side entry)		These contacts are applicable for wires terminated by ring, fork, or ferule terminals, and <b>also bare wire connections.</b>	<table border="1"> <tbody> <tr> <td>HW-U01-F</td> <td>HW-U01-MAU-F</td> <td>HW-U10-F</td> </tr> <tr> <td>HW-U01R-F</td> <td>HW-U01R-MAU-F</td> <td>HW-U10R-F</td> </tr> <tr> <td>HW-U01R-MAU-F (no side entry)</td> <td>HW-U10R-MAU-F (no side entry)</td> <td></td> </tr> </tbody> </table>			HW-U01-F	HW-U01-MAU-F	HW-U10-F	HW-U01R-F	HW-U01R-MAU-F	HW-U10R-F	HW-U01R-MAU-F (no side entry)	HW-U10R-MAU-F (no side entry)				
			HW-U01-F	HW-U01-MAU-F	HW-U10-F												
HW-U01R-F	HW-U01R-MAU-F	HW-U10R-F															
HW-U01R-MAU-F (no side entry)	HW-U10R-MAU-F (no side entry)																

Switches & Pilot Devices

Signaling Lights

Relays & Sockets

Timers

Contactors

Terminal Blocks

Circuit Breakers

Dimensions

Pushbuttons

Flush

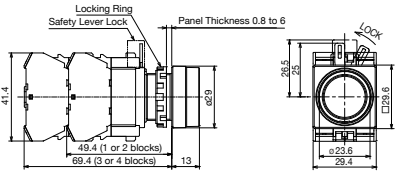

Extended

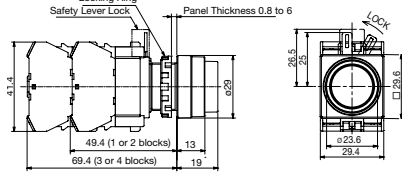

Extended with Full Shroud

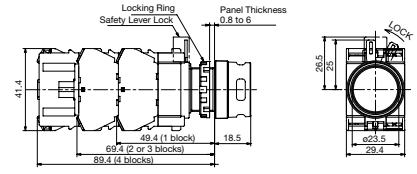

29mm Mushroom

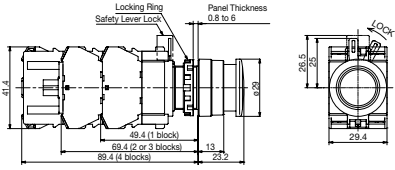

40mm Mushroom

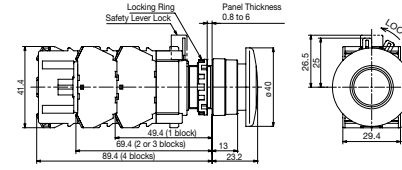

Mushroom with Full Shroud

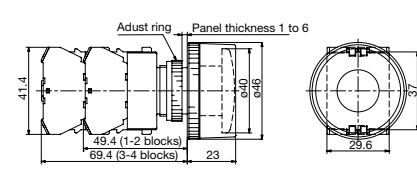

29mm Push-Lock-Turn-Reset

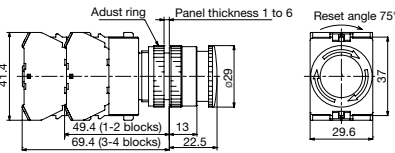

40mm Push-Lock-Turn-Reset

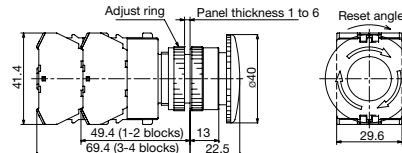

Keylock Push On/Off

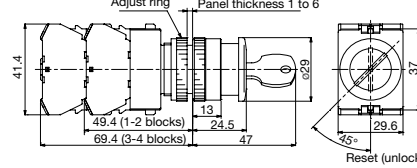

40mm Pushlock Key reset

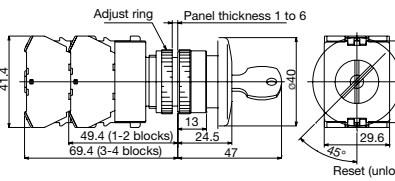

40mm Push-Pull

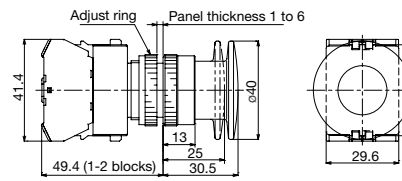

Square Flush

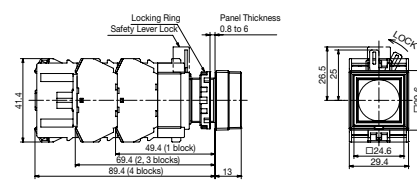

Square Extended

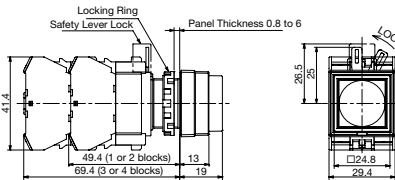

Selector Switches

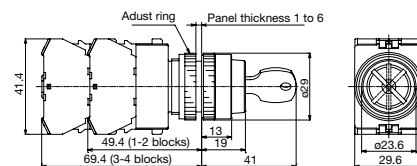
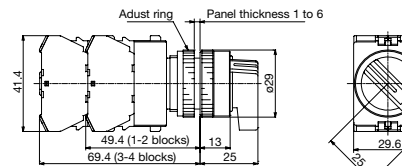
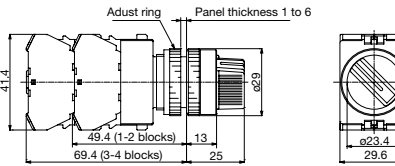

Dimensions continued

Illuminated Pushbuttons

Extended

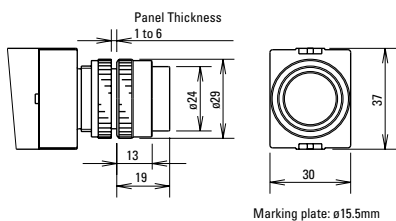

Extended with Full Shroud

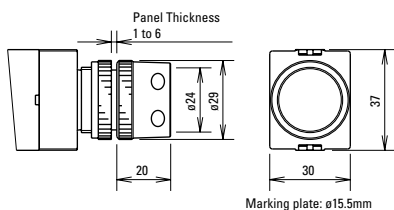

Square Extended

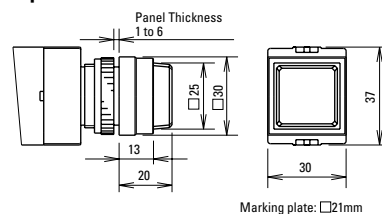

29mm Push-Turn-Reset

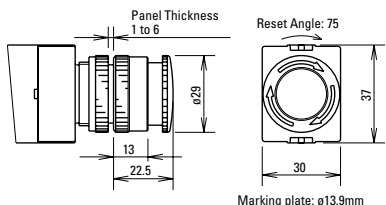

40mm Push-Turn-Reset

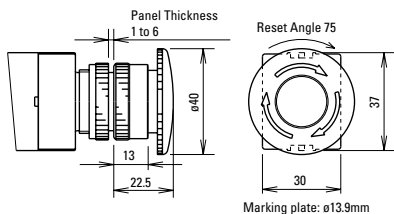

Mushroom

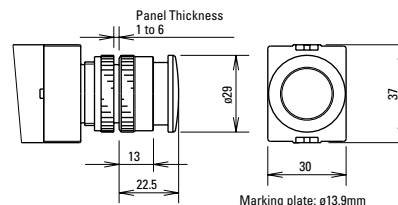

Push-Pull

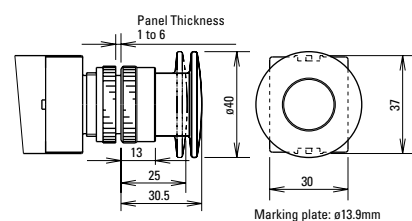

Illuminated Selector Switches

1 Contact Block with Full Voltage Adaptor

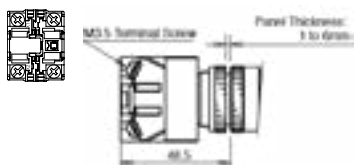

Transformer (2 blocks)

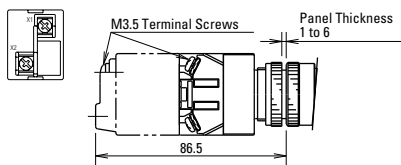

2 Contact Blocks with Full Voltage Adaptor

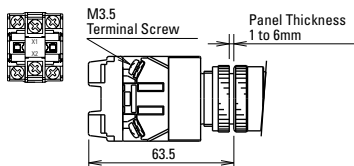

Transformer (4 blocks)

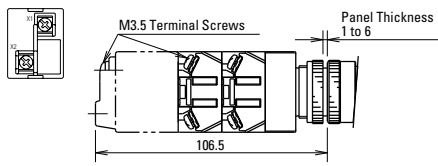

3 Contact Blocks with Full Voltage Adaptor

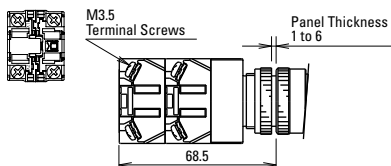

4 Contact Blocks with Full Voltage Adaptor

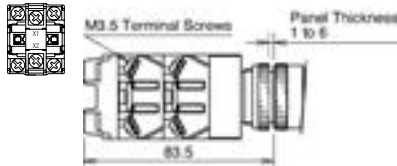

Dimensions continued

Pilot Lights

Round Flush APW1 Full Voltage

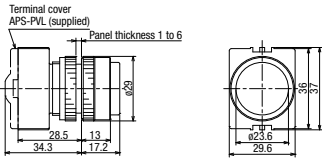

Round Flush Marking Type APW1B Full Voltage

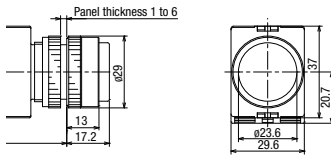

Dome APW2 Full Voltage

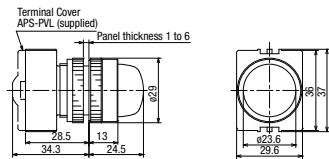

Square Flush Marking Type APQW1B Full Voltage

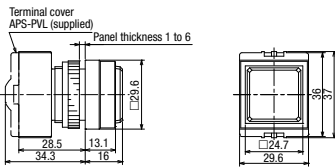

Illuminated Selector Switches

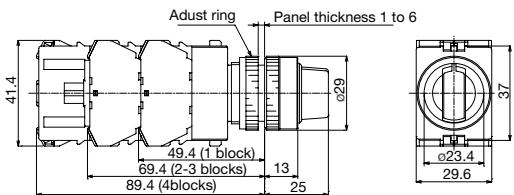

Round Flush APW1 Transformer

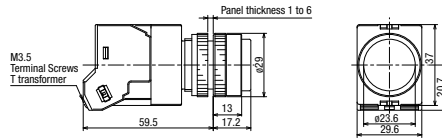

Round Flush Marking Type APW1B Transformer

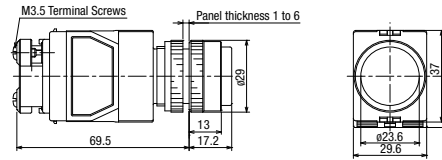

Dome APW2 Transformer

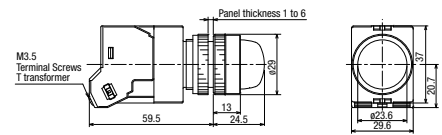

Square Flush Marking Type APQW1B Transformer

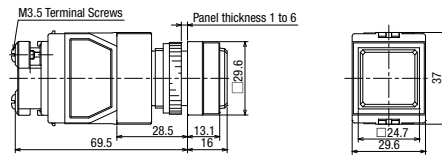

Dimensions continued

Panel Cut-Out

Diagram	Part	Dimension
	Pushbuttons	<ul style="list-style-type: none"> <li>The minimum mounting centers are applicable to switches with one layer of contact blocks (one to two contact blocks). When two layers of contact blocks are mounted, determine the minimum mounting centers in consideration of convenience for wiring.</li> <li>1*) ø40 mm mushroom button type: 40 mm minimum</li> <li>1*) 2-position, 3-position lever selector switch: 39 mm minimum</li> <li>1*) 4-position, 5-position lever selector switch: 50 mm minimum</li> <li>When high temperature is expected, take necessary measures such as securing sufficient mounting centers or using a cooling fan.</li> <li>The ☆3.2 +0.2/0 mm recess is for preventing rotation and is not necessary when the nameplate or anti-rotation ring is not used.</li> </ul> <p>All dimensions in mm.</p>
	Pilot Light	
	Illuminated Pushbuttons	
	Selector Switches	
	Illuminated Selector Switches	

- The Ø 0.137" (Ø 3.5mm) recess is necessary when either the nameplate or anti-rotation ring is used.
- \*1) >1.404" (36mm) for 2- or 3-position.  
>1.95" (50mm) for 4- or 5-position.

Accessory Dimensions

**OGL-31**  
Anti-Rotation Ring

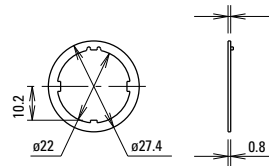

**OLW-C**  
Metal Button Guard

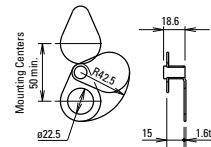

**OCW-11**  
Pushbutton Rubber Boot

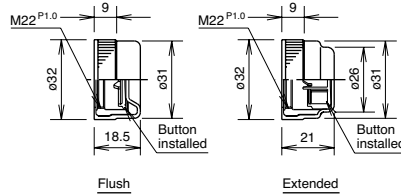

**OB-31**  
Mounting Hole Rubber Plug

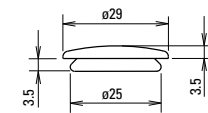

**HW9Z-KL1**  
Lock-out Adaptor

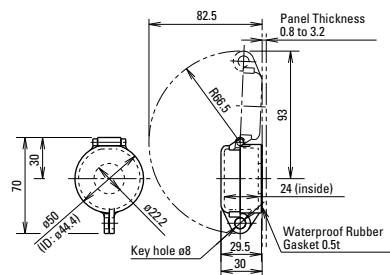

**AW-RP1B**  
Round Plastic Bezel



**AW-FP1B**  
Round Plastic w/Full Shroud



**AW-QF1B**  
Square Full Shroud

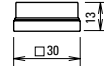

Finger-Safe Cover Dimensions

**APS-PVL**

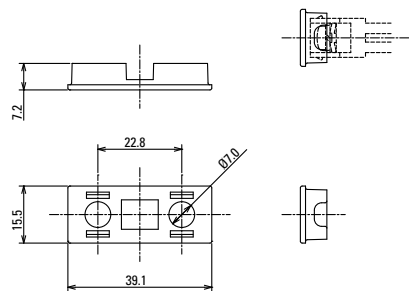

Switches & Pilot Devices

Signaling Lights

Relays & Sockets

Timers

Contactors

Terminal Blocks

Circuit Breakers

Component Construction and General Instructions – TW Series

Switches & Pilot Devices

Signaling Lights

Relays & Sockets

Timers

Contactors

Terminal Blocks

Circuit Breakers

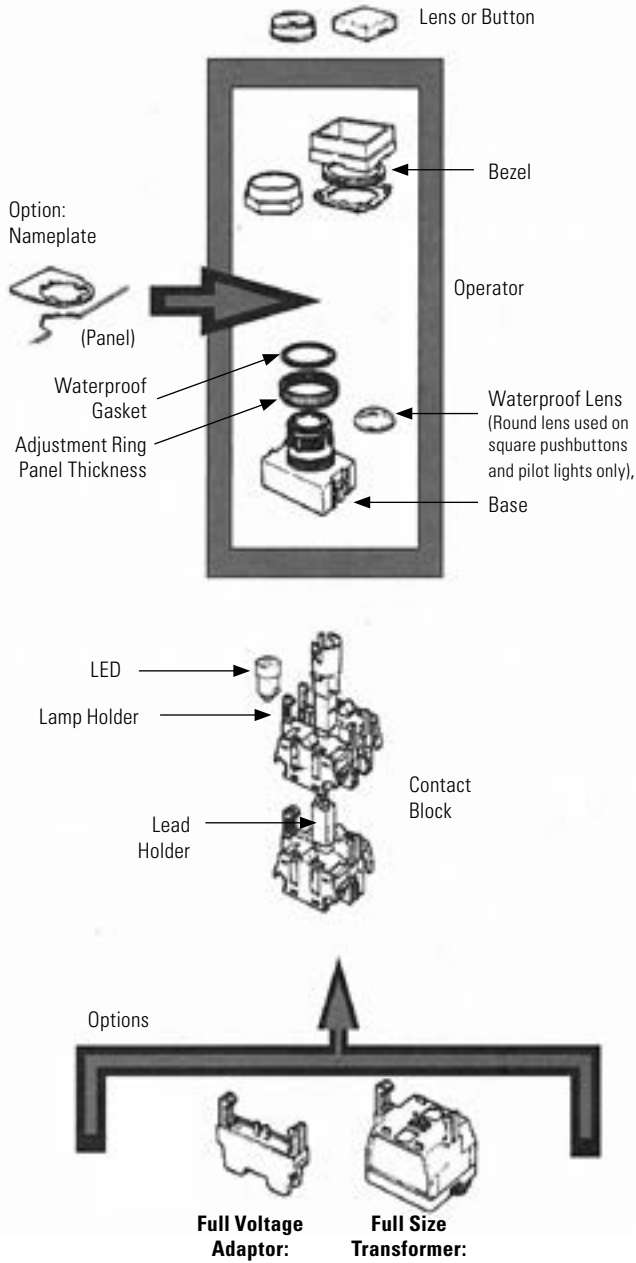

Instructions for Switches and Pilot Devices

TW Series: Adjustment for Panel Thickness

The panel thickness ring provides adjustment from 0.04" to 0.24" (1 to 6mm) in 0.004" (0.1mm) increments. Rotate the ring until the markings around the periphery are aligned for the desired thickness, as shown below.

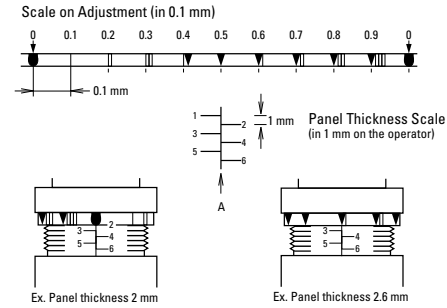

**Note:** When a nameplate or an anti-rotation ring is used, add 0.03" (0.8mm) to the panel thickness dimension.

An adjustment for panel thicknesses shown below can be made quickly by using the contact block remover.

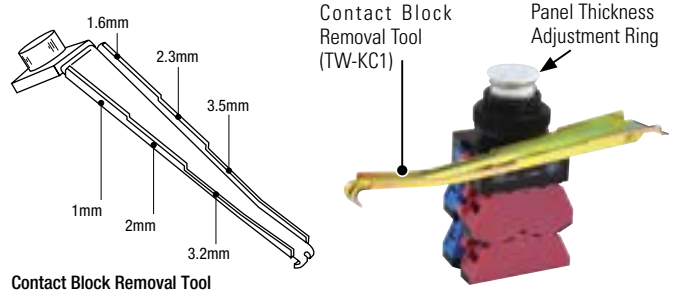

Instructions continued

Pilot Lights and Pushbuttons

IMPORTANT: Install the body of the TW control unit with the panel thickness scale facing up.

Octagonal and Round Bezels

Octagonal and round bezels screw into the operator. Use a locking ring wrench (optional) for secure tightening and easy removal. Round flush and extended buttons snap onto the operator base. Mushroom buttons screw onto the operator base.

Every round lens can be used with or without legend markings. Engraving can be done on a white translucent plate which is placed in the lens, or clear mylar can be printed and placed in the lens.

Round Marking Unit

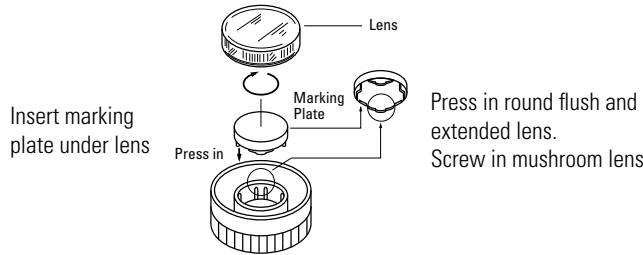

Square Bezels

Square bezels are installed in a 3-step procedure. First install the base plate from the front. Then install the lock nut using the nut locking wrench (optional). Finally, install the square bezel, which snap-fits onto the base plate. Square buttons also snap onto the operator base.

Every square lens can be used with or without legend markings. Engraving can be done on a white translucent plate which is placed in the lens, or clear mylar can be printed and placed in the lens. Square units include a round waterproof lens which screws into the operator. The square outer lens snaps on.

Square Marking Units

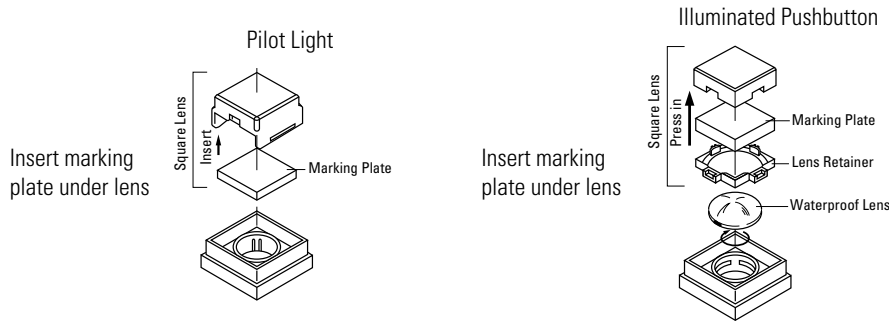

To remove square lens from operator, place a screwdriver under the indentation on the side of the lens. To remove the marking plate, place a screwdriver under the indentation and lift out the plate. The lens retainer can be removed by pressing a 3/16" screwdriver into one of the recesses.



Marking Plate Engraving Area

Shape	Engraving Area	Used With	Part Number
Round	Ø 0.55" (14mm)	Illuminated pushbuttons	ALW2B
	Ø 0.55" (14mm)	Pilot lights	APW2B
Mushroom	Ø 0.55" (14mm)	Illuminated mushroom	ALW3B
Square	□ 0.83" (21mm)	Square pilot lights	APQW1B
Square	□ 0.83" (21mm)	Square illuminated pushbuttons	ALQW2B



Instructions, continued

Selector Switches

The operator shaft of each unit has a recess to identify in which direction to install the handle. Align the handle with the recess. Press color insert (TW-HC1) into the handle and then press handle into the operator, as shown below.

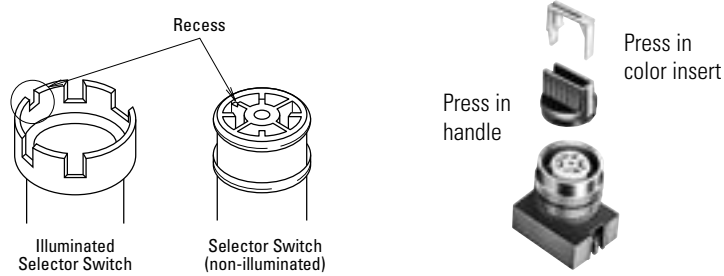

 Remove color insert before pulling out the handle.

Standard Operating Positions

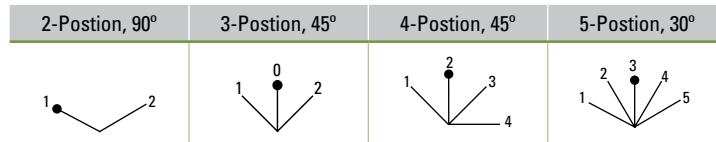

Positions: Non-Illuminated 3-Position Operators

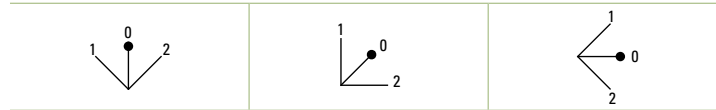

Installation of LED Illuminated Units

Transformers are recommended for use in areas subjected to inductive noise. When using full voltage types, install a protection diode as shown below. (Diode with DC power supply to protect against surges and noise.)

